



**Index  
SECTION H**

<b>PRODUCT</b>	<b>PAGE</b>
<b>GENERAL:</b>	
Warning and Safety Reminder .....	H-2
Stock Material Handling Products .....	H-3
<b>SCREW CONVEYORS:</b> .....	H-4 – H-123
Engineering Section I .....	H-4
Design and Layout Section II.....	H-36
Component Section III.....	H-51
Special Features Section IV .....	H-108
Installation and Maintenance Section V .....	H-121
<b>BUCKET ELEVATORS SECTION VI:</b> .....	H-124 – H-143
<b>DRAG CONVEYOR SECTION VII:</b> .....	H-144 – H-154
<b>VERTICAL SCREW ELEVATOR SECTION VIII:</b> .....	H-155 – H-164
<b>MODULAR PLASTIC SCREW CONVEYORS SECTION IX:</b> .....	H-165 - H-168
<b>SHAFTLESS SCREW CONVEYOR SECTION X:</b> .....	H-169 - H-172
<b>DATA SHEETS:</b> .....	H-173

CONVEYORS

# Safety



## WARNING AND SAFETY REMINDERS FOR SCREW, DRAG, AND BUCKET ELEVATOR CONVEYORS

APPROVED FOR DISTRIBUTION BY THE SCREW CONVEYOR SECTION OF THE CONVEYOR EQUIPMENT MANUFACTURERS ASSOCIATION (CEMA)

It is the responsibility of the contractor, installer, owner and user to install, maintain and operate the conveyor, components and, conveyor assemblies in such a manner as to comply with the Williams-Steiger Occupational Safety and Health Act and with all state and local laws and ordinances and the American National Standards Institute (ANSI) B20.1 Safety Code.

In order to avoid an unsafe or hazardous condition, the assemblies or parts must be installed and operated in accordance with the following minimum provisions.

1. Conveyors shall not be operated unless all covers and/or guards for the conveyor and drive unit are in place. If the conveyor is to be opened for inspection cleaning, maintenance or observation, the electric power to the motor driving the conveyor must be LOCKED OUT in such a manner that the conveyor cannot be restarted by anyone; however remote from the area, until conveyor cover or guards and drive guards have been properly replaced.
2. If the conveyor must have an open housing as a condition of its use and application, the entire conveyor is then to be guarded by a railing or fence in accordance with ANSI standard B20.1. (Request current edition and addenda)
3. Feed openings for shovel, front loaders or other manual or mechanical equipment shall be constructed in such a way that the conveyor opening is covered by a grating. If the nature of the material is such that a grating cannot be used, then the exposed section of the conveyor is to be guarded by a railing or fence and there shall be a warning sign posted.
4. Do not attempt any maintenance or repairs of the conveyor until power has been LOCKED OUT.
5. Always operate conveyor in accordance with these instructions and those contained

on the caution labels affixed to the equipment.

6. Do not place hands, feet, or any part of your body, in the conveyor.
7. Never walk on conveyor covers, grating or guards.
8. Do not use conveyor for any purpose other than that for which it was intended.
9. Do not poke or prod material into the conveyor with a bar or stick inserted through the openings.
10. Keep area around conveyor drive and control station free of debris and obstacles.
11. Eliminate all sources of stored energy (materials or devices that could cause conveyor components to move without power applied) before opening the conveyor
12. Do not attempt to clear a jammed conveyor until power has been LOCKED OUT.
13. Do not attempt field modification of conveyor or components.
14. Conveyors are not normally manufactured or designed to handle materials that are hazardous to personnel. These materials which are hazardous include those that are explosive, flammable, toxic or otherwise dangerous to personnel. Conveyors may be designed to handle these materials. Conveyors are not manufactured or designed to comply with local, state or federal codes for unfired pressure vessels. If hazardous materials are to be conveyed or if the conveyor is to be subjected to internal or external pressure, manufacturer should be consulted prior to any modifications.

CEMA insists that disconnecting and locking out the power to the motor driving the unit provides the only real protection against injury. Secondary safety devices are available; however, the decision as to their need and the type required must be made by the owner-assembler as we have no information regarding plant wiring, plant environment, the interlocking of the screw conveyor with other equipment, extent of plant automation, etc. Other devices should not be used as a substitute for locking out the power prior to removing guards or covers. We caution that use of the secondary devices may cause employees to develop a false sense of security and fail to lock out power before removing covers or guards. This could result in a serious injury should the secondary device fail or malfunction.

There are many kinds of electrical devices for interlocking of conveyors and conveyor systems such that if one conveyor in a system or process is stopped other equipment feeding it, or following it can also be automatically stopped.

Electrical controls, machinery guards, railings, walkways, arrangement of installation, training of personnel, etc., are necessary ingredients for a safe working place. It is the responsibility of the contractor, installer, owner and user to supplement the materials and services furnished with these necessary items to make the conveyor installation comply with the law and accepted standards.

Conveyor inlet and discharge openings are designed to connect to other equipment or machinery so that the flow of material into and out of the conveyor is completely enclosed.

One or more warning labels should be visible on conveyor housings, conveyor covers and elevator housings. If the labels attached to the equipment become illegible, please order replacement warning labels from the OEM or CEMA.

The Conveyor Equipment Manufacturers Association (CEMA) has produced an audio-visual presentation entitled "Safe Operation of Screw Conveyors, Drag Conveyors, and Bucket Elevators." CEMA encourages acquisition and use of this source of safety information to supplement your safety program.

CONVEYORS



PROMINENTLY DISPLAY THESE SAFETY LABELS ON INSTALLED EQUIPMENT

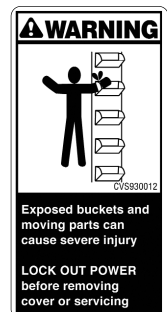
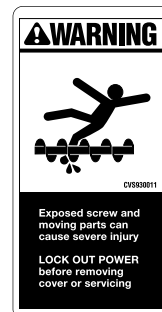
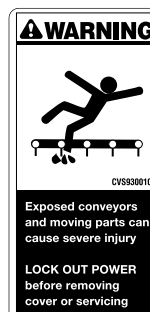

NOTICE: This document is provided by CEMA as a service to the industry in the interest of promoting safety. It is advisory only and it is not a substitute for a thorough safety program. Users should consult with qualified engineers and other safety professionals. CEMA makes no representations or warranties, either expressed or implied, and the users of this document assume full responsibility for the safe design and operation of equipment.



# Stock & MTO Screw Conveyor Components

## Screw Conveyor Components and Accessories

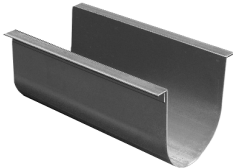

ANGLE FLANGED "U" TROUGH



FORM FLANGED "U" TROUGH

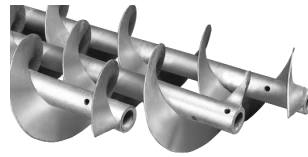

SECTIONAL SCREWS



SPECIALS

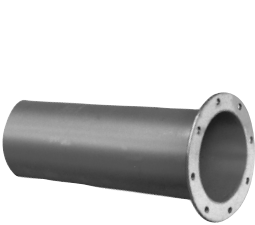

TUBULAR HOUSING

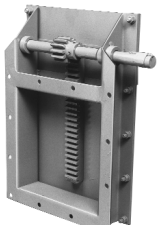

FLAT RACK AND PINION DISCHARGE GATE



TROUGH ENDS WITH AND WITHOUT FEET



SECTIONAL FLIGHTS



COUPLING SHAFTS

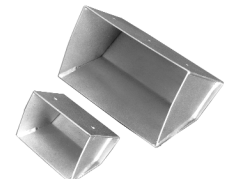

ELEVATOR BUCKETS

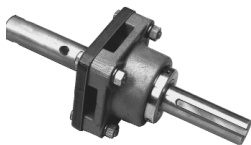

THRUST ASSEMBLY TYPE E WITH DRIVE SHAFT

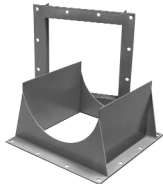

INLETS AND DISCHARGE SPOUTS DISCHARGE



SPLIT GLAND



HANGER STYLE 220



HANGER STYLE 226



HANGER STYLE 216



HANGER STYLE 70



HANGER STYLE 19B



TROUGH END BEARINGS BALL AND ROLLER



PACKING GLAND SHAFT SEAL COMPRESSION TYPE



WASTE PACK SHAFT SEAL



PLATE SHAFT SEAL



DROP-OUT SHAFT SEAL FLANGED PRODUCT



HANGER BEARINGS STYLE 220/226

*Martin* HARD IRON  
*Martin* BRONZE  
NYLATRON  
WHITE NYLON  
WOOD  
CERAMIC

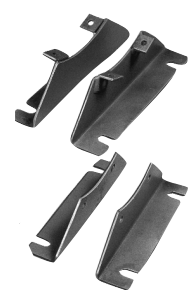

SADDLES AND FEET

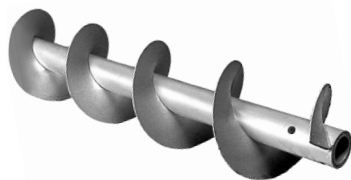

HELICOID SCREWS



HELICOID FLIGHTING RIGHT HAND AND LEFT HAND

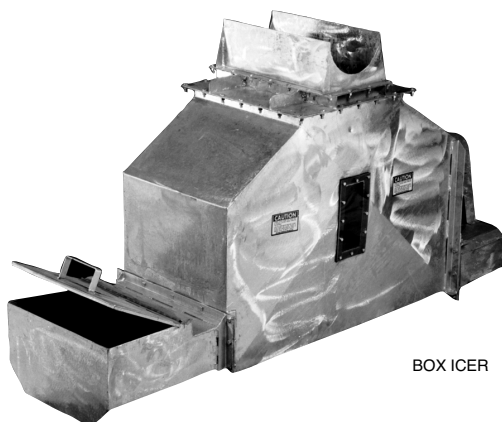

BOX ICER

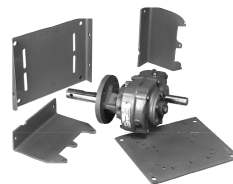

SCREW CONVEYOR DRIVE WITH ACCESSORIES

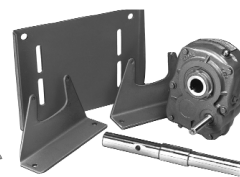

SPEED REDUCER SHAFT MOUNTED WITH ACCESSORIES.



FLANGED COVER WITH ACCESSORIES

*Martin* manufacturers the most complete line of stock components in the industry. We stock mild steel, stainless, galvanized, and many other items that are "special order" from the others in the industry.

**SECTION I**

**ENGINEERING SECTION I**

Introduction to Engineering Section .....	H-4
Screw Conveyor Design Procedure .....	H-5
Material Classification Code Chart .....	H-6
Material Characteristics Tables .....	H-7
Selection of Conveyor Size and Speed .....	H-17
Capacity Factor Tables.....	H-18
Capacity Table .....	H-19
Lump Size Limitations and Table .....	H-20
Component Group Selection.....	H-21
Hanger Bearing Selection .....	H-23
Horsepower Calculation.....	H-24
Torsional Ratings of Conveyor Components .....	H-27
Horsepower Ratings of Conveyor Components .....	H-28
Screw Conveyor End Thrust and Thermal Expansion .....	H-29
Screw Conveyor Deflection .....	H-30
Inclined and Vertical Screw Conveyors .....	H-32
Screw Feeders .....	H-33

**Introduction**

The following section is designed to present the necessary engineering information to properly design and layout most conveyor applications. The information has been compiled from many years of experience in successful design and application and from industry standards.

We hope that the information presented will be helpful to you in determining the type and size of screw conveyor that will best suit your needs.

The “Screw Conveyor Design Procedure” on the following page gives ten step-by-step instructions for properly designing a screw conveyor. These steps, plus the many following tables and formulas throughout the engineering section will enable you to design and detail screw conveyor for most applications.

If your requirements present any complications not covered in this section, we invite you to contact our Engineering Department for recommendations and suggestions.





**SCREW CONVEYOR DESIGN PROCEDURE**

STEP 1	Establish Known Factors	<ol style="list-style-type: none"> <li>1. Type of material to be conveyed.</li> <li>2. Maximum size of hard lumps.</li> <li>3. Percentage of hard lumps by volume.</li> <li>4. Capacity required, in cu.ft./hr.</li> <li>5. Capacity required, in lbs./hr.</li> <li>6. Distance material to be conveyed.</li> <li>7. Any additional factors that may affect conveyor or operations.</li> </ol>
STEP 2	Classify Material	Classify the material according to the system shown in Table 1-1. Or, if the material is included in Table 1-2, use the classification shown in Table 1-2.
STEP 3	Determine Design Capacity	Determine design capacity as described on pages H-17–H-19.
STEP 4	Determine Diameter and Speed	Using known capacity required in cu.ft./hr., material classification, and % trough loading (Table 1-2) determine diameter and speed from Table 1-6.
STEP 5	Check Minimum Screw Diameter for Lump Size Limitations	Using known screw diameter and percentage of hard lumps, check minimum screw diameter from Table 1-7.
STEP 6	Determine Type of Bearings	From Table 1-2, determine hanger bearing group for the material to be conveyed. Locate this bearing group in Table 1-11 for the type of bearing recommended.
STEP 7	Determine Horsepower	From Table 1-2, determine Horsepower Factor “F <sub>m</sub> ” for the material to be conveyed. Refer to page H-24 and calculate horsepower by the formula method.
STEP 8	Check Torsional and/or Horsepower ratings of Standard Conveyor Components	Using required horsepower from step 7 refer to pages H-27 and H-28 to check capacities of standard conveyor pipe, shafts and coupling bolts.
STEP 9	Select Components	Select basic components from Tables 1-8, 1-9, and 1-10 in accordance with Component Group listed in Table 1-2 for the material to be conveyed. Select balance of components from the Components Section of catalogue.
STEP 10	Conveyor Layouts	Refer to pages H-40 and H-41 for typical layout details.

# Table 1-1 Material Classification Code Chart



Major Class	Material Characteristics Included	Code Designation
Density	Bulk Density, Loose	Actual Lbs/PC
Size	Very Fine No. 200 Sieve (.0029") And Under No. 100 Sieve (.0059") And Under No. 40 Sieve (.016") And Under	A <sub>200</sub> A <sub>100</sub> A <sub>40</sub>
	Fine No. 6 Sieve (.132") And Under	B <sub>6</sub>
	Granular ½" And Under (6 Sieve to ½") 3" And Under (½ to 3") 7" And Under (3" to 7")	C <sub>½</sub> D <sub>3</sub> D <sub>7</sub>
	Lumpy 16" And Under (0" to 16") Over 16" To Be Specified X=Actual Maximum Size	D <sub>16</sub> D <sub>X</sub>
	Irregular Stringy, Fibrous, Cylindrical, Slabs, Etc.	E
Flowability	Very Free Flowing	1
	Free Flowing	2
	Average Flowability	3
	Sluggish	4
Abrasiveness	Mildly Abrasive	5
	Moderately Abrasive	6
	Extremely Abrasive	7
Miscellaneous Properties Or Hazards	Builds Up and Hardens	F
	Generates Static Electricity	G
	Decomposes — Deteriorates in Storage	H
	Flammability	J
	Becomes Plastic or Tends to Soften	K
	Very Dusty	L
	Aerates and Becomes a Fluid	M
	Explosiveness	N
	Stickiness — Adhesion	O
	Contaminable, Affecting Use	P
	Degradable, Affecting Use	Q
	Gives Off Harmful or Toxic Gas or Fumes	R
	Highly Corrosive	S
	Mildly Corrosive	T
	Hygroscopic	U
	Interlocks, Mats or Agglomerates	V
	Oils Present	W
	Packs Under Pressure	X
	Very Light and Fluffy — May Be Windswept	Y
Elevated Temperature	Z	

CONVEYORS



# Table 1-2 Material Characteristics

## Material Characteristics

The material characteristics table (page H-8 or H-16) lists the following Design Data for many materials.

- A. The weight per cubic foot data may be used to calculate the required capacity of the conveyor in cubic feet per hour.
- B. The material code for each material is as described in Table 1-1, and as interpreted below.
- C. The Intermediate Bearing Selection Code is used to properly select the intermediate hanger bearing from Table 1-11 (Page H-23).
- D. The Component Series Code is used to determine the correct components to be used as shown on page H-22.
- E. The Material Factor  $F_m$  is used in determining horsepower as described on pages H-24 thru H-26.
- F. The Trough Loading column indicates the proper percent of cross section loading to use in determining diameter and speed of the conveyor.

For screw conveyor design purposes, conveyed materials are classified in accordance with the code system in Table 1-1, and listed in Table 1-2.

Table 1-2 lists many materials that can be effectively conveyed by a screw conveyor. If a material is not listed in Table 1-2, it must be classified according to Table 1-1 or by referring to a listed material similar in weight, particle size and other characteristics.

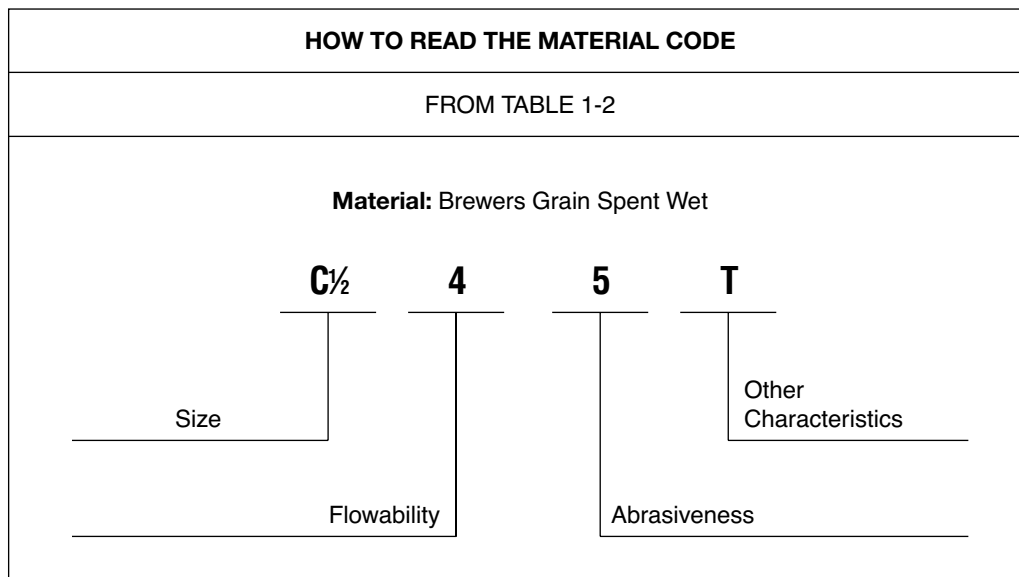

CONVEYORS

# Table 1-2 Material Characteristics



Material	Weight lbs. per cu. ft.	Intermediate Material Code	Bearing Selection	Component Series	Mat'l Factor Fm	Trough Loading
Adipic Acid	45	A 100-35	S	2	.5	30A
Alfalfa Meal	14-22	B6-45WY	H	2	.6	30A
Alfalfa Pellets	41-43	C½-25	H	2	.5	45
Alfalfa Seed	6 10-15	B6-15N	L-S-B	1	.4	45
Almonds, Broken	27-30	C½-35Q	H	2	.9	30A
Almonds, Whole Shelled	28-30	C½-35Q	H	2	.9	30A
Alum, Fine	45-50	B6-35U	L-S-B	1	.6	30A
Alum, Lumpy	50-60	B6-25	L-S	2	1.4	45
Alumina	55-65	B6-27MY	H	3	1.8	15
Alumina, Fine	35	A100-27MY	H	3	1.6	15
Alumina Sized Or Briquette	65	D3-37	H	3	2.0	15
Aluminate Gel (Aluminate Hydroxide)	45	B6-35	H	2	1.7	30A
Aluminum Chips, Dry	7-15	E-45V	H	2	1.2	30A
Aluminum Chips, Oily	7-15	E-45V	H	2	.8	30A
Aluminum Hydrate	13-20	C½-35	L-S-B	1	1.4	30A
Aluminum Ore (See Bauxite)	—	—	—	—	—	—
Aluminum Oxide	60-120	A100-17M	H	3	1.8	15
Aluminum Silicate (Andalusite)	49	C½-35S	L-S	3	.8	30A
Aluminum Sulfate	45-58	C½-25	L-S-B	1	1.0	45
Ammonium Chloride, Crystalline	45-52	A100-45FRS	L-S	3	.7	30A
Ammonium Nitrate	45-62	A40-35NTU	H	3	1.3	30A
Ammonium Sulfate	45-58	C½-35FOTU	L-S	1	1.0	30A
Antimony Powder	—	A100-35	H	2	1.6	30A
Apple Pomace, Dry	15	C½-45Y	H	2	1.0	30A
Arsenate Of Lead (See Lead Arsenate)	—	—	—	—	—	—
Arsenic Oxide (Arsenolite)	100-120	A100-35R	L-S-B	—	—	30A
Arsenic Pulverized	30	A100-25R	H	2	.8	45
Asbestos — Rock (Ore)	81	D3-37R	H	3	1.2	15
Asbestos — Shredded	20-40	E-46XY	H	2	1.0	30B
Ash, Black Ground	105	B6-35	L-S-B	1	2.0	30A
Ashes, Coal, Dry — ½"	35-45	C½-46TY	H	3	3.0	30B
Ashes, Coal, Dry — 3"	35-40	D3-46T	H	3	2.5	30B
Ashes, Coal, Wet — ½"	45-50	C½-46T	H	3	3.0	30B
Ashes, Coal, Wet — 3"	45-50	D3-46T	H	3	4.0	30B
Ashes, Fly (See Fly Ash)	—	—	—	—	—	—
Asphalt, Crushed — ½"	45	C½-45	H	2	2.0	30A
Bagasse	7-10	E-45RVXY	L-S-B	2	1.5	30A
Bakelite, Fine	30-45	B6-25	L-S-B	1	1.4	45
Baking Powder	40-55	A100-35	S	1	.6	30A
Baking Soda (Sodium Bicarbonate)	40-55	A100-25	S	1	.6	45
Barite (Barium Sulfate) + ½" — 3"	120-180	D3-36	H	3	2.6	30B
Barite, Powder	120-180	A100-35X	H	2	2.0	30A
Barium Carbonate	72	A100-45R	H	2	1.6	30A
Bark, Wood, Refuse	10-20	E-45TVY	H	3	2.0	30A
Barley, Fine, Ground	24-38	B6-35	L-S-B	1	.4	30A
Barley, Malted	31	C½-35	L-S-B	1	.4	30A
Barley, Meal	28	C½-35	L-S-B	1	.4	30A
Barley, Whole	36-48	B6-25N	L-S-B	1	.5	45
Basalt	80-105	B6-27	H	3	1.8	15
Bauxite, Dry, Ground	68	B6-25	H	2	1.8	45
Bauxite, Crushed — 3"	75-85	D3-36	H	3	2.5	30B
Beans, Castor, Meal	35-40	B6-35W	L-S-B	1	.8	30A
Beans, Castor, Whole Shelled	36	C½-15W	L-S-B	1	.5	45
Beans, Navy, Dry	48	C½-15	L-S-B	1	.5	45
Beans, Navy, Steeped	60	C½-25	L-S-B	1	.8	45

CONVEYORS



## Table 1-2 Material Characteristics (Cont'd)

Material	Weight lbs. per cu. ft.	Intermediate Material Code	Bearing Selection	Component Series	Mat'l Factor Fm	Trough Loading
Bentonite, Crude	34-40	D3-45X	H	2	1.2	30A
Bentonite, -100 Mesh	50-60	A100-25MXY	H	2	.7	45
Benzene Hexachloride	56	A100-45R	L-S-B	1	.6	30A
Bicarbonate of Soda (Baking Soda)	—	—	S	1	.6	—
Blood, Dried	35-45	D3-45U	H	2	2.0	30A
Blood, Ground, Dried	30	A100-35U	L-S	1	1.0	30A
Bone Ash (Tricalcium Phosphate)	40-50	A100-45	L-S	1	1.6	30A
Boneblack	20-25	A100-25Y	L-S	1	1.5	45
Bonechar	27-40	B6-35	L-S	1	1.6	30A
Bonemeal	50-60	B6-35	H	2	1.7	30A
Bones, Whole*	35-50	E-45V	H	2	3.0	30A
Bones, Crushed	35-50	D3-45	H	2	2.0	30A
Bones, Ground	50	B6-35	H	2	1.7	30A
Borate of Lime	60	A100-35	L-S-B	1	.6	30A
Borax, Fine	45-55	B6-25T	H	3	.7	30B
Borax Screening — ½"	55-60	C½-35	H	2	1.5	30A
Borax, 1½-2" Lump	55-60	D3-35	H	2	1.8	30A
Borax, 2"-3" Lump	60-70	D3-35	H	2	2.0	30A
Boric Acid, Fine	55	B6-25T	H	3	.8	30A
Boron	75	A100-37	H	2	1.0	30B
Bran, Rice — Rye — Wheat	16-20	B6-35NY	L-S-B	1	.5	30A
Braunite (Manganese Oxide)	120	A100-36	H	2	2.0	30B
Bread Crumbs	20-25	B6-35PQ	L-S-B	1	.6	30A
Brewer's Grain, Spent, Dry	14-30	C½-45	L-S-B	1	.5	30A
Brewer's Grain, Spent, Wet	55-60	C½-45T	L-S	2	.8	30A
Brick, Ground — ½"	100-120	B6-37	H	3	2.2	15
Bronze Chips	30-50	B6-45	H	2	2.0	30A
Buckwheat	37-42	B6-25N	L-S-B	1	.4	45
Calcine, Flour	75-85	A100-35	L-S-B	1	.7	30A
Calcium Carbide	70-90	D3-25N	H	2	2.0	30A
Calcium Carbonate (See Limestone)	—	—	—	—	—	—
Calcium Fluoride (See Fluorspar)	—	—	—	—	—	—
Calcium Hydrate (See Lime, Hydrated)	—	—	—	—	—	—
Calcium Hydroxide (See Lime, Hydrated)	—	—	—	—	—	—
Calcium Lactate	26-29	D3-45QTR	L-S	2	.6	30A
Calcium Oxide (See Lime, Unslaked)	—	—	—	—	—	—
Calcium Phosphate	40-50	A100-45	L-S-B	1	1.6	30A
Calcium Sulfate (See Gypsum)	—	—	—	—	—	—
Carbon, Activated, Dry Fine*	—	—	—	—	—	—
Carbon Black, Pelleted*	—	—	—	—	—	—
Carbon Black, Powder*	—	—	—	—	—	—
Carborundum	100	D3-27	H	3	3.0	15
Casein	36	B6-35	H	2	1.6	30A
Cashew Nuts	32-37	C½-45	H	2	.7	30A
Cast Iron, Chips	130-200	C½-45	H	2	4.0	30A
Caustic Soda	88	B6-35RSU	H	3	1.8	30A
Caustic Soda, Flakes	47	C½-45RSUX	L-S	3	1.5	30A
Cellite (See Diatomaceous Earth)	—	—	—	—	—	—
Cement, Clinker	75-95	D3-36	H	3	1.8	30B
Cement, Mortar	133	B6-35Q	H	3	3.0	30A
Cement, Portland	94	A100-26M	H	2	1.4	30B
Cement, Aerated (Portland)	60-75	A100-16M	H	2	1.4	30B
Cerrusite (See Lead Carbonate)	—	—	—	—	—	—
Chalk, Crushed	75-95	D3-25	H	2	1.9	30A
Chalk, Pulverized	67-75	A100-25MXY	H	2	1.4	45
Charcoal, Ground	18-28	A100-45	H	2	1.2	30A

CONVEYORS



# Table 1-2 Material Characteristics (Cont'd)



Material	Weight lbs. per cu. ft.	Intermediate Material Code	Bearing Selection	Component Series	Mat'l Factor Fm	Trough Loading
Charcoal, Lumps	18-28	D3-45Q	H	2	1.4	30A
Chocolate, Cake Pressed	40-45	D3-25	S	2	1.5	30A
Chrome Ore	125-140	D3-36	H	3	2.5	30B
Cinders, Blast Furnace	57	D3-36T	H	3	1.9	30B
Cinders, Coal	40	D3-36T	H	3	1.8	30B
Clay (See Bentonite, Diatomaceous Earth, Fuller's Earth, Kaolin & Marl)	—	—	—	—	—	—
Clay, Ceramic, Dry, Fines	60-80	A100-35P	L-S-B	1	1.5	30A
Clay, Calcined	80-100	B6-36	H	3	2.4	30B
Clay, Brick, Dry, Fines	100-120	C½-36	H	3	2.0	30B
Clay, Dry, Lumpy	60-75	D3-35	H	2	1.8	30A
Clinker, Cement (See Cement Clinker)	—	—	—	—	—	—
Clover Seed	45-48	B6-25N	L-S-B	1	.4	45
Coal, Anthracite (River & Culm)	55-61	B6-35TY	L-S	2	1.0	30A
Coal, Anthracite, Sized-½"	49-61	C½-25	L-S	2	1.0	45
Coal, Bituminous, Mined	40-60	D3-35LNXY	L-S	1	.9	30A
Coal, Bituminous, Mined, Sized	45-50	D3-35QV	L-S	1	1.0	30A
Coal, Bituminous, Mined, Slack	43-50	C½-45T	L-S	2	.9	30A
Coal, Lignite	37-45	D3-35T	H	2	1.0	30A
Cocoa Beans	30-45	C½-25Q	L-S	1	.5	45
Cocoa, Nibs	35	C½-25	H	2	.5	45
Cocoa, Powdered	30-35	A100-45XY	S	1	.9	30A
Cocoanut, Shredded	20-22	E-45	S	2	1.5	30A
Coffee, Chaff	20	B6-25MY	L-S	1	1.0	45
Coffee, Green Bean	25-32	C½-25PQ	L-S	1	.5	45
Coffee, Ground, Dry	25	A40-35P	L-S	1	.6	30A
Coffee, Ground, Wet	35-45	A40-45X	L-S	1	.6	30A
Coffee, Roasted Bean	20-30	C½-25PQ	S	1	.4	45
Coffee, Soluble	19	A40-35PUY	S	1	.4	45
Coke, Breeze	25-35	C½-37	H	3	1.2	15
Coke, Loose	23-35	D7-37	H	3	1.2	15
Coke, Petrol, Calcined	35-45	D7-37	H	3	1.3	15
Compost	30-50	D7-45TV	L-S	3	1.0	30A
Concrete, Pre-Mix Dry	85-120	C½-36U	H	3	3.0	30B
Copper Ore	120-150	DX-36	H	3	4.0	30B
Copper Ore, Crushed	100-150	D3-36	H	3	4.0	30B
Copper Sulphate, (Bluestone)	75-95	C½-35S	L-S	2	1.0	30A
Copperas (See Ferrous Sulphate)	—	—	—	—	—	—
Copra, Cake Ground	40-45	B6-45HW	L-S-B	1	.7	30A
Copra, Cake, Lumpy	25-30	D3-35HW	L-S-B	2	.8	30A
Copra, Lumpy	22	E-35HW	L-S-B	2	1.0	30A
Copra, Meal	40-45	B6-35HW	H	2	.7	30A
Cork, Fine Ground	5-15	B6-35JNY	L-S-B	1	.5	30A
Cork, Granulated	12-15	C½-35JY	L-S-B	1	.5	30A
Corn, Cracked	40-50	B6-25P	L-S-B	1	.7	45
Corn Cobs, Ground	17	C½-25Y	L-S-B	1	.6	45
Corn Cobs, Whole*	12-15	E-35	L-S	2		30A
Corn Ear*	56	E-35	L-S	2		30A
Corn Germ	21	B6-35PY	L-S-B	1	.4	30A
Corn Grits	40-45	B6-35P	L-S-B	1	.5	30A
Cornmeal	32-40	B6-35P	L-S	1	.5	30A
Corn Oil, Cake	25	D7-45HW	L-S	1	.6	30A
Corn Seed	45	C½-25PQ	L-S-B	1	.4	45
Corn Shelled	45	C½-25	L-S-B	1	.4	45
Corn Sugar	30-35	B6-35PU	S	1	1.0	30A
Cottonseed, Cake, Crushed	40-45	C½-45HW	L-S	1	1.0	30A

CONVEYORS



## Table 1-2 Material Characteristics (Cont'd)

Material	Weight lbs. per cu. ft.	Intermediate Material Code	Bearing Selection	Component Series	Mat'l Factor Fm	Trough Loading
Cottonseed, Cake, Lumpy	40-45	D7-45HW	L-S	2	1.0	30A
Cottonseed, Dry, Delinted	22-40	C½-25X	L-S	1	.6	45
Cottonseed, Dry, Not Delinted	18-25	C½-45XY	L-S	1	.9	30A
Cottonseed, Flakes	20-25	C½-35HWY	L-S	1	.8	30A
Cottonseed, Hulls	12	B6-35Y	L-S	1	.9	30A
Cottonseed, Meal, Expeller	25-30	B6-45HW	L-S	3	.5	30A
Cottonseed, Meal, Extracted	35-40	B6-45HW	L-S	1	.5	30A
Cottonseed, Meats, Dry	40	B6-35HW	L-S	1	.6	30A
Cottonseed, Meats, Rolled	35-40	C½-45HW	L-S	1	.6	30A
Cracklings, Crushed	40-50	D3-45HW	L-S-B	2	1.3	30A
Cryolite, Dust	75-90	A100-36L	H	2	2.0	30B
Cryolite, Lumpy	90-110	D16-36	H	2	2.1	30B
Cullet, Fine	80-120	C½-37	H	3	2.0	15
Cullet, Lump	80-120	D16-37	H	3	2.5	15
Culm, (See Coal, Anthracite)	—	—	—	—	—	—
Cupric Sulphate (Copper Sulfate)	—	—	—	—	—	—
Detergent (See Soap Detergent)	—	—	—	—	—	—
Diatomaceous Earth	11-17	A40-36Y	H	3	1.6	30B
Dicalcium Phosphate	40-50	A40-35	L-S-B	1	1.6	30A
Disodium Phosphate	25-31	A40-35	H	3	.5	30A
Distiller's Grain, Spent Dry	30	B6-35	H	2	.5	30A
Distiller's Grain, Spent Wet	40-60	C½-45V	L-S	3	.8	30A
Dolomite, Crushed	80-100	C½-36	H	2	2.0	30B
Dolomite, Lumpy	90-100	DX-36	H	2	2.0	30B
Earth, Loam, Dry, Loose	76	C½-36	H	2	1.2	30B
Ebonite, Crushed	63-70	C½-35	L-S-B	1	.8	30A
Egg Powder	16	A40-35MPY	S	1	1.0	30A
Epsom Salts (Magnesium Sulfate)	40-50	A40-35U	L-S-B	1	.8	30A
Feldspar, Ground	65-80	A100-37	H	2	2.0	15
Feldspar, Lumps	90-100	D7-37	H	2	2.0	15
Feldspar, Powder	100	A200-36	H	2	2.0	30B
Feldspar, Screenings	75-80	C½-37	H	2	2.0	15
Ferrous Sulfide — ½"	120-135	C½-26	H	2	2.0	30B
Ferrous Sulfide — 100M	105-120	A100-36	H	2	2.0	30B
Ferrous Sulphate	50-75	C½-35U	H	2	1.0	30A
Fish Meal	35-40	C½-45HP	L-S-B	1	1.0	30A
Fish Scrap	40-50	D7-45H	L-S-B	2	1.5	30A
Flaxseed	43-45	B6-35X	L-S-B	1	.4	30A
Flaxseed Cake (Linseed Cake)	48-50	D7-45W	L-S	2	.7	30A
Flaxseed Meal (Linseed Meal)	25-45	B6-45W	L-S	1	.4	30A
Flour Wheat	33-40	A40-45LP	S	1	.6	30A
Flue Dust, Basic Oxygen Furnace	45-60	A40-36LM	H	3	3.5	30B
Flue Dust, Blast Furnace	110-125	A40-36	H	3	3.5	30B
Flue Dust, Boiler H. Dry	30-45	A40-36LM	H	3	2.0	30B
Fluorspar, Fine (Calcium Fluoride)	80-100	B6-36	H	2	2.0	30B
Fluorspar, Lumps	90-110	D7-36	H	2	2.0	30B
Fly Ash	30-45	A40-36M	H	3	2.0	30B
Foundry Sand, Dry (See Sand)	—	—	—	—	—	—
Fuller's Earth, Dry, Raw	30-40	A40-25	H	2	2.0	15
Fuller's Earth, Oily, Spent	60-65	C½-450W	H	3	2.0	30A
Fuller's Earth, Calcined	40	A100-25	H	3	2.0	15
Galena (See Lead Sulfide)	—	—	—	—	—	—
Gelatine, Granulated	32	B6-35PU	S	1	.8	30A
Gilsonite	37	C½-35	H	3	1.5	30A
Glass, Batch	80-100	C½-37	H	3	2.5	15
Glue, Ground	40	B6-45U	H	2	1.7	30A

CONVEYORS

# Table 1-2 Material Characteristics (Cont'd)



Material	Weight lbs. per cu. ft.	Intermediate Material Code	Bearing Selection	Component Series	Mat'l Factor Fm	Trough Loading
Glue, Pearl	40	C½-35U	L-S-B	1	.5	30A
Glue, Veg. Powdered	40	A40-45U	L-S-B	1	.6	30A
Gluten, Meal	40	B6-35P	L-S	1	.6	30A
Granite, Fine	80-90	C½-27	H	3	2.5	15
Grape Pomace	15-20	D3-45U	H	2	1.4	30A
Graphite Flake	40	B6-25LP	L-S-B	1	.5	45
Graphite Flour	28	A100-35LMP	L-S-B	1	.5	30A
Graphite Ore	65-75	DX-35L	H	2	1.0	30A
Guano Dry*	70	C½-35	L-S	3	2.0	30A
Gypsum, Calcined	55-60	B6-35U	H	2	1.6	30A
Gypsum, Calcined, Powdered	60-80	A100-35U	H	2	2.0	30A
Gypsum, Raw — 1"	70-80	D3-25	H	2	2.0	30A
Hay, Chopped*	8-12	C½-35JY	L-S	2	1.6	30A
Hexanedioic Acid (See Adipic Acid)	—	—	—	—	—	—
Hominy, Dry	35-50	C½-25	L-S-B	1	.4	45
Hops, Spent, Dry	35	D3-35	L-S-B	2	1.0	30A
Hops, Spent, Wet	50-55	D3-45V	L-S	2	1.5	30A
Ice, Crushed	35-45	D3-35Q	L-S	2	.4	30A
Ice, Flaked*	40-45	C½-35Q	S	1	.6	30A
Ice, Cubes	33-35	D3-35Q	S	1	.4	30A
Ice, Shell	33-35	D3-45Q	S	1	.4	30A
Ilmenite Ore	140-160	D3-37	H	3	2.0	15
Iron Ore Concentrate	120-180	A40-37	H	3	2.2	15
Iron Oxide Pigment	25	A100-36LMP	H	2	1.0	30B
Iron Oxide, Millscale	75	C½-36	H	2	1.6	30B
Iron Pyrites (See Ferrous Sulfide)	—	—	—	—	—	—
Iron Sulphate (See Ferrous Sulfate)	—	—	—	—	—	—
Iron Sulfide (See Ferrous Sulfide)	—	—	—	—	—	—
Iron Vitriol (See Ferrous Sulfate)	—	—	—	—	—	—
Kafir (Corn)	40-45	C½-25	H	3	.5	45
Kaolin Clay	63	D3-25	H	2	2.0	30A
Kaolin Clay-Talc	32-56	A40-35LMP	H	2	2.0	30A
Kryalith (See Cryolite)	—	—	—	—	—	—
Lactose	32	A40-35PU	S	1	.6	30A
Lamp Black (See Carbon Black)	—	—	—	—	—	—
Lead Arsenate	72	A40-35R	L-S-B	1	1.4	30A
Lead Arsenite	72	A40-35R	L-S-B	1	1.4	30A
Lead Carbonate	240-260	A40-35R	H	2	1.0	30A
Lead Ore — ¼"	200-270	B6-35	H	3	1.4	30A
Lead Ore — ½"	180-230	C½-36	H	3	1.4	30B
Lead Oxide (Red Lead) — 100 Mesh	30-150	A100-35P	H	2	1.2	30A
Lead Oxide (Red Lead) — 200 Mesh	30-180	A200-35LP	H	2	1.2	30A
Lead Sulphide — 100 Mesh	240-260	A100-35R	H	2	1.0	30A
Lignite (See Coal Lignite)	—	—	—	—	—	—
Limanite, Ore, Brown	120	C½-47	H	3	1.7	15
Lime, Ground, Unslaked	60-65	B6-35U	L-S-B	1	.6	30A
Lime Hydrated	40	B6-35LM	H	2	.8	30A
Lime, Hydrated, Pulverized	32-40	A40-35LM	L-S	1	.6	30A
Lime, Pebble	53-56	C½-25HU	L-S	2	2.0	45
Limestone, Agricultural	68	B6-35	H	2	2.0	30A
Limestone, Crushed	85-90	DX-36	H	2	2.0	30B
Limestone, Dust	55-95	A40-46MY	H	2	1.6-2.0	30B
Lindane (Benzene Hexachloride)	—	—	—	—	—	—
Linseed (See Flaxseed)	—	—	—	—	—	—
Litharge (Lead Oxide)	—	—	—	—	—	—
Lithopone	45-50	A325-35MR	L-S	1	1.0	30A

CONVEYORS



## Table 1-2 Material Characteristics (Cont'd)

Material	Weight lbs. per cu. ft.	Intermediate Material Code	Bearing Selection	Component Series	Mat'l Factor Fm	Trough Loading
Maize (See Milo)	—	—	—	—	—	—
Malt, Dry, Ground	20-30	B6-35NP	L-S-B	1	.5	30A
Malt, Meal	36-40	B6-25P	L-S-B	1	.4	45
Malt, Dry Whole	20-30	C½-35N	L-S-B	1	.5	30A
Malt, Sprouts	13-15	C½-35P	L-S-B	1	.4	30A
Magnesium Chloride (Magnesite)	33	C½-45	L-S	1	1.0	30A
Manganese Dioxide*	70-85	A100-35NRT	L-S	2	1.5	30A
Manganese Ore	125-140	DX-37	H	3	2.0	15
Manganese Oxide	120	A100-36	H	2	2.0	30B
Manganese Sulfate	70	C½-37	H	3	2.4	15
Marble, Crushed	80-95	B6-37	H	3	2.0	15
Marl, (Clay)	80	DX-36	H	2	1.6	30B
Meat, Ground	50-55	E-45HQTX	L-S	2	1.5	30A
Meat, Scrap (Wbone)	40	E-46H	H	2	1.5	30B
Mica, Flakes	17-22	B6-16MY	H	2	1.0	30B
Mica, Ground	13-15	B6-36	H	2	.9	30B
Mica, Pulverized	13-15	A100-36M	H	2	1.0	30B
Milk, Dried, Flake	5-6	B6-35PUY	S	1	.4	30A
Milk, Malted	27-30	A40-45PX	S	1	.9	30A
Milk, Powdered	20-45	B6-25PM	S	1	.5	45
Milk Sugar	32	A100-35PX	S	1	.6	30A
Milk, Whole, Powdered	20-36	B6-35PUX	S	1	.5	30A
Mill Scale (Steel)	120-125	E-46T	H	3	3.0	30B
Milo, Ground	32-36	B6-25	L-S-B	1	.5	45
Milo Maize (Kafir)	40-45	B6-15N	L-S-B	1	.4	45
Molybdenite Powder	107	B6-26	H	2	1.5	30B
Monosodium Phosphate	50	B6-36	H	2	.6	30B
Mortar, Wet*	150	E-46T	H	3	3.0	30B
Mustard Seed	45	B6-15N	L-S-B	1	.4	45
Naphthalene Flakes	45	B6-35	L-S-B	1	.7	30A
Niacin (Nicotinic Acid)	35	A40-35P	H	2	2.5	30A
Oats	26	C½-25MN	L-S-B	1	.4	45
Oats, Crimped	19-26	C½-35	L-S-B	1	.5	30A
Oats, Crushed	22	B6-45NY	L-S-B	1	.6	30A
Oats, Flour	35	A100-35	L-S-B	1	.5	30A
Oat Hulls	8-12	B6-35NY	L-S-B	1	.5	30A
Oats, Rolled	19-24	C½-35NY	L-S-B	1	.6	30A
Oleo Margarine (Margarine)	59	E-45HKPWX	L-S	2	.4	30A
Orange Peel, Dry	15	E-45	L-S	2	1.5	30A
Oxalic Acid Crystals — Ethane Diacid Crystals	60	B6-35QS	L-S	1	1.0	30A
Oyster Shells, Ground	50-60	C½-36T	H	3	1.6-2.0	30B
Oyster Shells, Whole	80	D3-36TV	H	3	2.1-2.5	30B
Paper Pulp (4% or less)	62	E-45	L-S	2	1.5	30A
Paper Pulp (6% to 15%)	60-62	E-45	L-S	2	1.5	30A
Paraffin Cake — ½"	45	C½-45K	L-S	1	.6	30A
Peanuts, Clean, in shell	15-20	D3-35Q	L-S	2	.6	30A
Peanut Meal	30	B6-35P	S	1	.6	30A
Peanuts, Raw, Uncleaned (unshelled)	15-20	D3-36Q	H	3	.7	30B
Peanuts, Shelled	35-45	C½-35Q	S	1	.4	30A
Peas, Dried	45-50	C½-15NQ	L-S-B	1	.5	45
Perlite — Expanded	8-12	C½-36	H	2	.6	30B
Phosphate Acid Fertilizer	60	B6-25T	L-S	2	1.4	45
Phosphate Disodium (See Sodium Phosphate)	—	—	—	—	—	—
Phosphate Rock, Broken	75-85	DX-36	H	2	2.1	30B
Phosphate Rock, Pulverized	60	B6-36	H	2	1.7	30B

CONVEYORS

# Table 1-2 Material Characteristics (Cont'd)



Material	Weight lbs. per cu. ft.	Intermediate Material Code	Bearing Selection	Component Series	Mat'l Factor Fm	Trough Loading
Phosphate Sand	90-100	B6-37	H	3	2.0	15
Plaster of Paris (See Gypsum)	—	—	—	—	—	—
Plumbago (See Graphite)	—	—	—	—	—	—
Polystyrene Beads	40	B6-35PQ	S	1	.4	30A
Polyvinyl, Chloride Powder	20-30	A100-45KT	S	2	1.0	30A
Polyvinyl, Chloride Pellets	20-30	E-45KPQT	S	1	.6	30A
Polyethylene, Resin Pellets	30-35	C½-45Q	L-S	1	.4	30A
Potash (Muriate) Dry	70	B6-37	H	3	2.0	15
Potash (Muriate) Mine Run	75	DX-37	H	3	2.2	15
Potassium Carbonate	51	B6-36	H	2	1.0	30B
Potassium Chloride Pellets	120-130	C½-25TU	H	3	1.6	45
Potassium Nitrate — ½"	76	C½-16NT	H	3	1.2	30B
Potassium Nitrate — ⅜"	80	B6-26NT	H	3	1.2	30B
Potassium Sulfate	42-48	B6-46X	H	2	1.0	30B
Potato Flour	48	A200-35MNP	L-S	1	.5	30A
Pumice — ⅛"	42-48	B6-46	H	3	1.6	30B
Pyrite, Pellets	120-130	C½-26	H	3	2.0	30B
Quartz — 100 Mesh	70-80	A100-27	H	3	1.7	15
Quartz — ½"	80-90	C½-27	H	3	2.0	15
Rice, Bran	20	B6-35NY	L-S-B	1	.4	30A
Rice, Grits	42-45	B6-35P	L-S-B	1	.4	30A
Rice, Polished	30	C½-15P	L-S-B	1	.4	45
Rice, Hulled	45-49	C½-25P	L-S-B	1	.4	45
Rice, Hulls	20-21	B6-35NY	L-S-B	1	.4	30A
Rice, Rough	32-36	C½-35N	L-S-B	1	.6	30A
Rosin — ½"	65-68	C½-45Q	L-S-B	1	1.5	30A
Rubber, Reclaimed Ground	23-50	C½-45	L-S-B	1	.8	30A
Rubber, Pelleted	50-55	D3-45	L-S-B	2	1.5	30A
Rye	42-48	B6-15N	L-S-B	1	.4	45
Rye Bran	15-20	B6-35Y	L-S-B	1	.4	45
Rye Feed	33	B6-35N	L-S-B	1	.5	30A
Rye Meal	35-40	B6-35	L-S-B	1	.5	30A
Rye Middlings	42	B6-35	L-S	1	.5	30A
Rye, Shorts	32-33	C½-35	L-S	2	.5	30A
Safflower, Cake	50	D3-26	H	2	.6	30B
Safflower, Meal	50	B6-35	L-S-B	1	.6	30A
Safflower Seed	45	B6-15N	L-S-B	1	.4	45
Saffron (See Safflower)	—	—	—	—	—	—
Sal Ammoniac (Ammonium Chloride)	—	—	—	—	—	—
Salt Cake, Dry Coarse	85	B6-36TU	H	3	2.1	30B
Salt Cake, Dry Pulverized	65-85	B6-36TU	H	3	1.7	30B
Salicylic Acid	29	B6-37U	H	3	.6	15
Salt, Dry Coarse	45-60	C½-36TU	H	3	1.0	30B
Salt, Dry Fine	70-80	B6-36TU	H	3	1.7	30B
Salt peter — (See Potassium Nitrate)	—	—	—	—	—	—
Sand Dry Bank (Damp)	110-130	B6-47	H	3	2.8	15
Sand Dry Bank (Dry)	90-110	B6-37	H	3	1.7	15
Sand Dry Silica	90-100	B6-27	H	3	2.0	15
Sand Foundry (Shake Out)	90-100	D3-37Z	H	3	2.6	15
Sand (Resin Coated) Silica	104	B6-27	H	3	2.0	15
Sand (Resin Coated) Zircon	115	A100-27	H	3	2.3	15
Sawdust, Dry	10-13	B6-45UX	L-S-B	1	1.4	15
Sea — Coal	65	B6-36	H	2	1.0	30B
Sesame Seed	27-41	B6-26	H	2	.6	30B
Shale, Crushed	85-90	C½-36	H	2	2.0	30B
Shellac, Powdered or Granulated	31	B6-35P	S	1	.6	30A

CONVEYORS





## Table 1-2 Material Characteristics (Cont'd)

Material	Weight lbs. per cu. ft.	Material Code	Intermediate Bearing Selection	Component Series	Mat'l Factor F <sub>m</sub>	Trough Loading
Silicon Dioxide (See Quartz)	—	—	—	—	—	—
Silica, Flour	80	A40-46	H	2	1.5	30B
Silica Gel + ½" - 3"	45	D3-37HKQU	H	3	2.0	15
Slag, Blast Furnace Crushed	130-180	D3-37Y	H	3	2.4	15
Slag, Furnace Granular, Dry	60-65	C½-37	H	3	2.2	15
Slate, Crushed, — ½"	80-90	C½-36	H	2	2.0	30B
Slate, Ground, — ½"	82-85	B6-36	H	2	1.6	30B
Sludge, Sewage, Dried	40-50	E-47TW	H	3	.8	15
Sludge, Sewage, Dry Ground	45-55	B-46S	H	2	.8	30B
Soap, Beads or Granules	15-35	B6-35Q	L-S-B	1	.6	30A
Soap, Chips	15-25	C½-35Q	L-S-B	1	.6	30A
Soap Detergent	15-50	B6-35FQ	L-S-B	1	.8	30A
Soap, Flakes	5-15	B6-35QXY	L-S-B	1	.6	30A
Soap, Powder	20-25	B6-25X	L-S-B	1	.9	45
Soapstone, Talc, Fine	40-50	A200-45XY	L-S-B	1	2.0	30A
Soda Ash, Heavy	55-65	B6-36	H	2	2.0	30B
Soda Ash, Light	20-35	A40-36Y	H	2	1.6	30B
Sodium Aluminate, Ground	72	B6-36	H	2	1.0	30B
Sodium Aluminum Fluoride (See Kryolite)	—	—	—	—	—	—
Sodium Aluminum Sulphate*	75	A100-36	H	2	1.0	30B
Sodium Bentonite (See Bentonite)	—	—	—	—	—	—
Sodium Bicarbonate (See Baking Soda)	—	—	—	—	—	—
Sodium Chloride (See Salt)	—	—	—	—	—	—
Sodium Carbonate (See Soda Ash)	—	—	—	—	—	—
Sodium Hydrate (See Caustic Soda)	—	—	—	—	—	—
Sodium Hydroxide (See Caustic Soda)	—	—	—	—	—	—
Sodium Borate (See Borax)	—	—	—	—	—	—
Sodium Nitrate	70-80	D3-25NS	L-S	2	1.2	30A
Sodium Phosphate	50-60	A-35	L-S	1	.9	30A
Sodium Sulfate (See Salt Cake)	—	—	—	—	—	—
Sodium Sulfite	96	B6-46X	H	2	1.5	30B
Sorghum, Seed (See Kafir or Milo)	—	—	—	—	—	—
Soybean, Cake	40-43	D3-35W	L-S-B	2	1.0	30A
Soybean, Cracked	30-40	C½-36NW	H	2	.5	30B
Soybean, Flake, Raw	18-25	C½-35Y	L-S-B	1	.8	30A
Soybean, Flour	27-30	A40-35MN	L-S-B	1	.8	30A
Soybean Meal, Cold	40	B6-35	L-S-B	1	.5	30A
Soybean Meal Hot	40	B6-35T	L-S	2	.5	30A
Soybeans, Whole	45-50	C½-26NW	H	2	1.0	30B
Starch	25-50	A40-15M	L-S-B	1	1.0	45
Steel Turnings, Crushed	100-150	D3-46WV	H	3	3.0	30B
Sugar Beet, Pulp, Dry	12-15	C½-26	H	2	.9	30B
Sugar Beet, Pulp, Wet	25-45	C½-35X	L-S-B	1	1.2	30A
Sugar, Refined, Granulated Dry	50-55	B6-35PU	S	1	1.0-1.2	30A
Sugar, Refined, Granulated Wet	55-65	C½-35X	S	1	1.4-2.0	30A
Sugar, Powdered	50-60	A100-35PX	S	1	.8	30A
Sugar, Raw	55-65	B6-35PX	S	1	1.5	30A
Sulphur, Crushed — ½"	50-60	C½-35N	L-S	1	.8	30A
Sulphur, Lumpy, — 3"	80-85	D3-35N	L-S	2	.8	30A
Sulphur, Powdered	50-60	A40-35MN	L-S	1	.6	30A
Sunflower Seed	19-38	C½-15	L-S-B	1	.5	45
Talcum, — ½"	80-90	C½-36	H	2	.9	30B
Talcum Powder	50-60	A200-36M	H	2	.8	30B
Tanbark, Ground*	55	B6-45	L-S-B	1	.7	30A
Timothy Seed	36	B6-35NY	L-S-B	1	.6	30A
Titanium Dioxide (See Ilmenite Ore)	—	—	—	—	—	—

CONVEYORS

# Table 1-2 Material Characteristics (Cont'd)



Material	Weight lbs. per cu. ft.	Material Code	Intermediate Bearing Selection	Component Series	Mat'l Factor F <sub>m</sub>	Trough Loading
Tobacco, Scraps	15-25	D3-45Y	L-S	2	.8	30A
Tobacco, Snuff	30	B6-45MQ	L-S-B	1	.9	30A
Tricalcium Phosphate	40-50	A40-45	L-S	1	1.6	30A
Triple Super Phosphate	50-55	B6-36RS	H	3	2.0	30B
Trisodium Phosphate	60	C½-36	H	2	1.7	30B
Trisodium Phosphate Granular	60	B6-36	H	2	1.7	30B
Trisodium Phosphate, Pulverized	50	A40-36	H	2	1.6	30B
Tung Nut Meats, Crushed	28	D3-25W	L-S	2	.8	30A
Tung Nuts	25-30	D3-15	L-S	2	.7	30A
Urea Prills, Coated	43-46	B6-25	L-S-B	1	1.2	45
Vermiculite, Expanded	16	C½-35Y	L-S	1	.5	30A
Vermiculite, Ore	80	D3-36	H	2	1.0	30B
Vetch	48	B6-16N	L-S-B	1	.4	30B
Walnut Shells, Crushed	35-45	B6-36	H	2	1.0	30B
Wheat	45-48	C½-25N	L-S-B	1	.4	45
Wheat, Cracked	40-45	B6-25N	L-S-B	1	.4	45
Wheat, Germ	18-28	B6-25	L-S-B	1	.4	45
White Lead, Dry	75-100	A40-36MR	H	2	1.0	30B
Wood Chips, Screened	10-30	D3-45VY	L-S	2	.6	30A
Wood Flour	16-36	B6-35N	L-S	1	.4	30A
Wood Shavings	8-16	E-45VY	L-S	2	1.5	30A
Zinc, Concentrate Residue	75-80	B6-37	H	3	1.0	15
Zinc Oxide, Heavy	30-35	A100-45X	L-S	1	1.0	30A
Zinc Oxide, Light	10-15	A100-45XY	L-S	1	1.0	30A

\*Consult Factory



## Selection of Conveyor Size and Speed

In order to determine the size and speed of a screw conveyor, it is necessary first to establish the material code number. It will be seen from what follows that this code number controls the cross-sectional loading that should be used. The various cross-sectional loadings shown in the Capacity Table (Table 1-6) are for use with the standard screw conveyor components indicated in the Component Group Selection Guide on page H-22 and are for use where the conveying operation is controlled with volumetric feeders and where the material is uniformly fed into the conveyor housing and discharged from it. Check lump size limitations before choosing conveyor diameter. See Table 1-7.

### Capacity Table

The capacity table, (Table 1-6), gives the capacities in cubic feet per hour at one revolution per minute for various size screw conveyors for four cross-sectional loadings. Also shown are capacities in cubic feet per hour at the maximum recommended revolutions per minute.

The capacity values given in the table will be found satisfactory for most applications. Where the capacity of a screw conveyor is very critical, especially when handling a material not listed in Table 1-2, it is best to consult our Engineering Department.

The maximum capacity of any size screw conveyor for a wide range of materials, and various conditions of loading, may be obtained from Table 1-6 by noting the values of cubic feet per hour at maximum recommended speed.

### Conveyor Speed

For screw conveyors with screws having standard pitch helical flights the conveyor speed may be calculated by the formula:

$$N = \frac{\text{Required capacity, cubic feet per hour}}{\text{Cubic feet per hour at 1 revolution per minute}}$$

$$N = \text{revolutions per minute of screw, (but not greater than the maximum recommended speed.)}$$

For the calculation of conveyor speeds where special types of screws are used, such as short pitch screws, cut flights, cut and folded flights and ribbon flights, an equivalent required capacity must be used, based on factors in the Tables 1-3, 4, 5.

Factor  $CF_1$  relates to the pitch of the screw. Factor  $CF_2$  relates to the type of the flight. Factor  $CF_3$  relates to the use of mixing paddles within the flight pitches.

The equivalent capacity then is found by multiplying the required capacity by the capacity factors. See Tables 1-3, 4, 5 for capacity factors.

$$\left( \begin{array}{c} \text{Equiv. Capacity} \\ \text{Cubic Feet Per Hour} \end{array} \right) = \left( \begin{array}{c} \text{Required Capacity} \\ \text{Cubic Feet Per Hour} \end{array} \right) (CF_1) (CF_2) (CF_3)$$

# Capacity Factors



**Table 1-3**

Special Conveyor Pitch Capacity Factor $CF_1$		
Pitch	Description	$CF_1$
Standard	Pitch = Diameter of Screw	1.00
Short	Pitch = $\frac{2}{3}$ Diameter of Screw	1.50
Half	Pitch = $\frac{1}{2}$ Diameter of Screw	2.00
Long	Pitch = $\frac{1}{4}$ Diameter of Screw	0.67

**Table 1-4**

Special Conveyor Flight Capacity Factor $CF_2$			
Type of Flight	Conveyor Loading		
	15%	30%	45%
Cut Flight	1.95	1.57	1.43
Cut & Folded Flight	N.R.*	3.75	2.54
Ribbon Flight	1.04	1.37	1.62

\*Not recommended  
If none of the above flight modifications are used:  $CF_2 = 1.0$

**Table 1-5**

Special Conveyor Mixing Paddle Capacity $CF_3$					
Standard Paddles at 45° Reverse Pitch	Paddles Per Pitch				
	None	1	2	3	4
Factor $CF_3$	1.00	1.08	1.16	1.24	1.32

CONVEYORS



# Capacity Table Horizontal Screw Conveyors

(Consult Factory for Inclined Conveyors)

Table 1-6

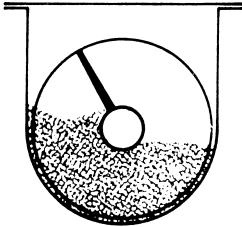
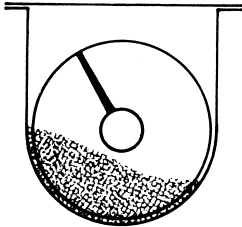
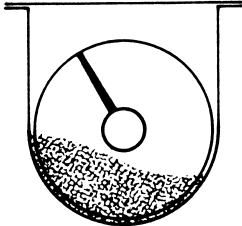
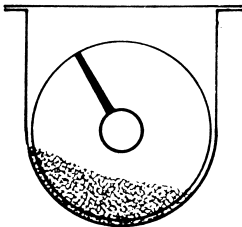
Trough Loading	Screw Dia. Inch	Capacity Cubic Feet Per Hour (Full Pitch)		Max. RPM
		At One RPM	At Max RPM	
<b>45%</b> 	4	0.62	114	184
	6	2.23	368	165
	9	8.20	1270	155
	10	11.40	1710	150
	12	19.40	2820	145
	14	31.20	4370	140
	16	46.70	6060	130
	18	67.60	8120	120
	20	93.70	10300	110
	24	164.00	16400	100
	30	323.00	29070	90
<b>30% A</b> 	4	0.41	53	130
	6	1.49	180	120
	9	5.45	545	100
	10	7.57	720	95
	12	12.90	1160	90
	14	20.80	1770	85
	16	31.20	2500	80
	18	45.00	3380	75
	20	62.80	4370	70
	24	109.00	7100	65
	30	216.00	12960	60
<b>30% B</b> 	4	0.41	29	72
	6	1.49	90	60
	9	5.45	300	55
	10	7.60	418	55
	12	12.90	645	50
	14	20.80	1040	50
	16	31.20	1400	45
	18	45.00	2025	45
	20	62.80	2500	40
	24	109.00	4360	40
	30	216.00	7560	35
<b>15%</b> 	4	0.21	15	72
	6	0.75	45	60
	9	2.72	150	55
	10	3.80	210	55
	12	6.40	325	50
	14	10.40	520	50
	16	15.60	700	45
	18	22.50	1010	45
	20	31.20	1250	40
	24	54.60	2180	40
	30	108.00	3780	35

CONVEYORS



# Lump Size Limitations



The size of a screw conveyor not only depends on the capacity required, but also on the size and proportion of lumps in the material to be handled. The size of a lump is the maximum dimension it has. If a lump has one dimension much longer than its transverse cross-section, the long dimension or length would determine the lump size.

The character of the lump also is involved. Some materials have hard lumps that won't break up in transit through a screw conveyor. In that case, provision must be made to handle these lumps. Other materials may have lumps that are fairly hard, but degradable in transit through the screw conveyor, thus reducing the lump size to be handled. Still other materials have lumps that are easily broken in a screw conveyor and lumps of these materials impose no limitations.

Three classes of lump sizes are shown in TABLE 1-7 and as follows

### Class 1

A mixture of lumps and fines in which not more than 10% are lumps ranging from maximum size to one half of the maximum; and 90% are lumps smaller than one half of the maximum size.

### Class 2

A mixture of lumps and fines in which not more than 25% are lumps ranging from the maximum size to one half of the maximum; and 75% are lumps smaller than one half of the maximum size.

### Class 3

A mixture of lumps only in which 95% or more are lumps ranging from maximum size to one half of the maximum size; and 5% or less are lumps less than one tenth of the maximum size.

**Table 1-7**

Maximum Lump Size Table					
Screw Diameter Inches	Pipe * O.D. Inches	Radial Clearance Inches Δ	Class I 10% Lumps Max. Lump, Inch	Class II 25% Lumps Max. Lump, Inch	Class III 95% Lumps Max. Lump, Inch
6	2 <sup>5</sup> / <sub>8</sub>	2 <sup>5</sup> / <sub>8</sub>	1 <sup>1</sup> / <sub>4</sub>	3/4	1/2
9	2 <sup>5</sup> / <sub>8</sub>	3 <sup>3</sup> / <sub>8</sub>	2 <sup>1</sup> / <sub>4</sub>	1 <sup>1</sup> / <sub>2</sub>	3/4
9	2 <sup>1</sup> / <sub>2</sub>	3 <sup>3</sup> / <sub>8</sub>	2 <sup>1</sup> / <sub>4</sub>	1 <sup>1</sup> / <sub>2</sub>	3/4
12	2 <sup>5</sup> / <sub>8</sub>	5 <sup>1</sup> / <sub>8</sub>	2 <sup>3</sup> / <sub>4</sub>	2	1
12	3 <sup>1</sup> / <sub>2</sub>	4 <sup>3</sup> / <sub>4</sub>	2 <sup>3</sup> / <sub>4</sub>	2	1
12	4	4 <sup>1</sup> / <sub>2</sub>	2 <sup>3</sup> / <sub>4</sub>	2	1
14	3 <sup>1</sup> / <sub>2</sub>	5 <sup>3</sup> / <sub>4</sub>	3 <sup>1</sup> / <sub>4</sub>	2 <sup>1</sup> / <sub>2</sub>	1 <sup>1</sup> / <sub>4</sub>
14	4	5 <sup>1</sup> / <sub>2</sub>	2 <sup>1</sup> / <sub>2</sub>	1 <sup>1</sup> / <sub>4</sub>	1 <sup>1</sup> / <sub>4</sub>
16	4	6 <sup>1</sup> / <sub>2</sub>	3 <sup>3</sup> / <sub>4</sub>	2 <sup>3</sup> / <sub>4</sub>	1 <sup>1</sup> / <sub>2</sub>
16	4 <sup>1</sup> / <sub>2</sub>	6 <sup>3</sup> / <sub>4</sub>	3 <sup>3</sup> / <sub>4</sub>	2 <sup>3</sup> / <sub>4</sub>	1 <sup>1</sup> / <sub>2</sub>
18	4	7 <sup>1</sup> / <sub>2</sub>	4 <sup>1</sup> / <sub>4</sub>	3	1 <sup>1</sup> / <sub>4</sub>
18	4 <sup>1</sup> / <sub>2</sub>	7 <sup>1</sup> / <sub>2</sub>	4 <sup>1</sup> / <sub>4</sub>	3	1 <sup>1</sup> / <sub>4</sub>
20	4	8 <sup>1</sup> / <sub>2</sub>	4 <sup>3</sup> / <sub>4</sub>	3 <sup>1</sup> / <sub>2</sub>	2
20	4 <sup>1</sup> / <sub>2</sub>	8 <sup>3</sup> / <sub>4</sub>	4 <sup>3</sup> / <sub>4</sub>	3 <sup>1</sup> / <sub>2</sub>	2
24	4 <sup>1</sup> / <sub>2</sub>	10 <sup>1</sup> / <sub>4</sub>	6	3 <sup>3</sup> / <sub>4</sub>	2 <sup>1</sup> / <sub>2</sub>
30	4 <sup>1</sup> / <sub>2</sub>	13 <sup>1</sup> / <sub>4</sub>	8	5	3

\* For special pipe sizes, consult factory.

Δ Radial clearance is the distance between the bottom of the trough and the bottom of the conveyor pipe.

### EXAMPLE: Lump Size Limitations

To illustrate the selection of a conveyor size from the Maximum Lump Size Table, Table 1-7, consider crushed ice as the conveyed material. Refer to the material charts Table 1-2 and find crushed ice and its material code D3-35Q and weight of 35-45 lbs./C.F. D3 means that the lump size is 1/2" to 3", this is noted by referring to the material classification code chart on page H-6. From actual specifications regarding crushed ice it is known that crushed ice has a maximum lump size of 1 1/2" and only 25% of the lumps are 1 1/2". With this information refer to Table 1-7, Maximum Lump Size Table. Under the column Class II and 1 1/2" Max. lump size read across to the minimum screw diameter which will be 9".



## Component Selection

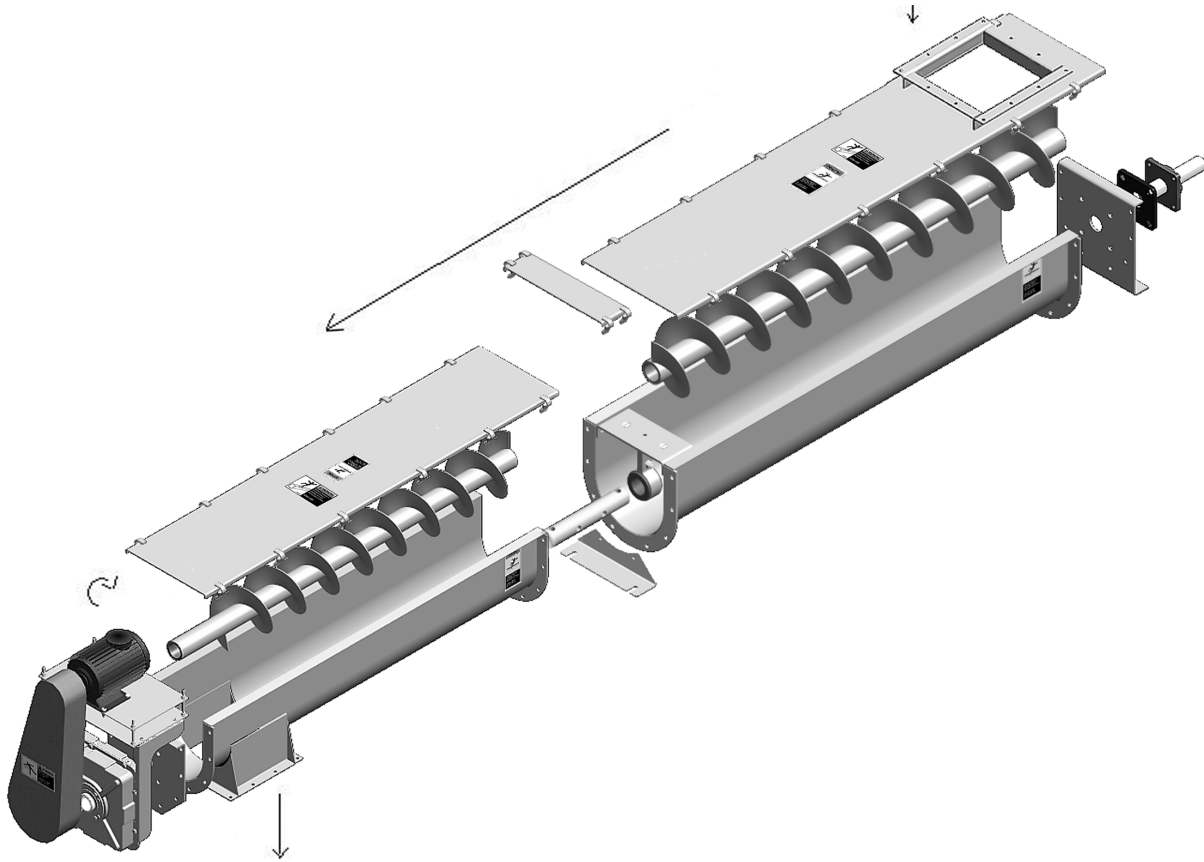

### Component Groups

To facilitate the selection of proper specifications for a screw conveyor for a particular duty, screw conveyors are broken down into three Component Groups. These groups relate both to the Material Classification Code and also to screw size, pipe size, type of bearings and trough thickness.

Referring to Table 1-2, find the component series designation of the material to be conveyed.

Having made the Component Series selection, refer to Tables 1-8, 9, 10 which give the specifications of the various sizes of conveyor screws. (The tabulated screw numbers in this table refer to standard specifications for screws found on pages H-79 - H-83 Component Section.) These standards give complete data on the screws such as the length of standard sections, minimum edge thickness of screw flight, bushing data, bolt size, bolt spacing, etc.

**EXAMPLE:** For a screw conveyor to handle brewers grain, spent wet, refer to the material characteristics Table 1-2. Note that the component series column refers to series 2. Refer now to page H-22, component selection, Table 1-9, component group 2. The standard shaft sizes, screw flight designations, trough gauges and cover gauges are listed for each screw diameter.

# Component Selection



**Table 1-8**

Component Group 1					
Screw Diameter Inches	Coupling Diameter Inches	Screw Number		Thickness, U.S. Standard Gauge or Inches	
		Helicoid Flights	Sectional Flights	Trough	Cover
6	1½	6H304	6S307	16 Ga.	16 Ga.
9	1½	9H306	9S307	14 Ga.	14 Ga.
9	2	9H406	9S409	14 Ga.	14 Ga.
12	2	12H408	12S409	12 Ga.	14 Ga.
12	2⅞	12H508	12S509	12 Ga.	14 Ga.
14	2⅞	14H508	14S509	12 Ga.	14 Ga.
16	3	16H610	16S612	12 Ga.	14 Ga.
18	3	—	18S612	10 Ga.	12 Ga.
20	3	—	20S612	10 Ga.	12 Ga.
24	3⅞	—	24S712	10 Ga.	12 Ga.
30	3⅞	—	30S712	10 Ga.	12 Ga.

**Table 1-9**

Component Group 2					
Screw Diameter Inches	Coupling Diameter Inches	Screw Number		Thickness, U.S. Standard Gauge or Inches	
		Helicoid Flights	Sectional Flights	Trough	Cover
6	1½	6H308	6S309	14 Ga..	16 Ga..
9	1½	9H312	9S309	10 Ga.	14 Ga.
9	2	9H412	9S412	10 Ga.	14 Ga.
12	2	12H412	12S412	⅜ In.	14 Ga.
12	2⅞	12H512	12S512	⅜ In.	14 Ga.
12	3	12H614	12S616	⅜ In.	14 Ga.
14	2⅞	—	14S512	⅜ In.	14 Ga.
14	3	14H614	14S616	⅜ In.	14 Ga.
16	3	16H614	16S616	⅜ In.	14 Ga.
18	3	—	18S616	⅜ In.	12 Ga.
20	3	—	20S616	⅜ In.	12 Ga.
24	3⅞	—	24S716	⅜ In.	12 Ga.
30	3⅞	—	30S716	⅜ In.	12 Ga.

**Table 1-10**

Component Group 3					
Screw Diameter Inches	Coupling Diameter Inches	Screw Number		Thickness, U.S. Standard Gauge or Inches	
		Helicoid Flights	Sectional Flights	Trough	Cover
6	1½	6H312	6S312	10 Ga.	16 Ga.
9	1½	9H312	9S312	⅞ In.	14 Ga.
9	2	9H414	9S416	⅞ In.	14 Ga.
12	2	12H412	12S412	¼ In.	14 Ga.
12	2⅞	12H512	12S512	¼ In.	14 Ga.
12	3	12H614	12S616	¼ In.	14 Ga.
14	3	—	14S624	¼ In.	14 Ga.
16	3	—	16S624	¼ In.	14 Ga.
18	3	—	18S624	¼ In.	12 Ga.
20	3	—	20S624	¼ In.	12 Ga.
24	3⅞	—	24S724	¼ In.	12 Ga.
30	3⅞	—	30S724	¼ In.	12 Ga.

CONVEYORS



# Bearing Selection

The selection of bearing material for intermediate hangers is based on experience together with a knowledge of the characteristics of the material to be conveyed. By referring to the material characteristic tables, page H-8 thru H-16 the intermediate hanger bearing selection can be made by viewing the Bearing Selection column. The bearing selection will be made from one of the following types: B, L, S, H. The various bearing types available in the above categories can be selected from the following table.

**Table 1-11**

Hanger Bearing Selection				
Bearing Component Groups	Bearing Types	Recommended Coupling Shaft Material $\Delta$	Max. Recommended Operating Temperature	$F_b$
B	Ball	Standard	180°	1.0
L	Bronze	Standard	300°F	
S	<i>Martin</i> Bronze*	Standard	850°F	2.0
	Graphite Bronze	Standard	500°F	
	Oil Impreg. Bronze	Standard	200°F	
	Oil Impreg. Wood	Standard	160°F	
	Nylatron	Standard	250°F	
	Nylon	Standard	160°F	
	Teflon	Standard	250°F	
	UHMW	Standard	225°F	
	Melamine (MCB)	Standard	250°F	
Urethane	Standard	200°F		
H	<i>Martin</i> Hard Iron*	Hardened	500°F	3.4
	Hard Iron	Hardened	500°F	4.4
	Hard Surfaced	Hardened or Special	500°F	
	Stellite	Special	500°F	
Ceramic	Special	1,000°F		

\*Sintered Metal. Self-lubricating.

$\Delta$  OTHER TYPES OF COUPLING SHAFT MATERIALS

Various alloys, stainless steel, and other types of shafting can be furnished as required.

# Horsepower Requirements



## Horizontal Screw Conveyors

**\*Consult Factory for Inclined Conveyors or Screw Feeders**

The horsepower required to operate a horizontal screw conveyor is based on proper installation, uniform and regular feed rate to the conveyor and other design criteria as determined in this book.

The horsepower requirement is the total of the horsepower to overcome friction (HP<sub>f</sub>) and the horsepower to transport the material at the specified rate (HP<sub>m</sub>) multiplied by the overload factor F<sub>O</sub> and divided by the total drive efficiency e, or:

$$HP_f = \frac{LN F_d f_b}{1,000,000} = \text{(Horsepower to run an empty conveyor)}$$

$$HP_m = \frac{CLW F_f F_m F_p}{1,000,000} = \text{(Horsepower to move the material)}$$

$$\text{Total HP} = \frac{(HP_f + HP_m) F_O}{e}$$

The following factors determine the horsepower requirement of a screw conveyor operating under the foregoing conditions.

- L = Total length of conveyor, feet
- N = Operating speed, RPM (revolutions per minute)
- F<sub>d</sub> = Conveyor diameter factor (See Table 1-12)
- F<sub>b</sub> = Hanger bearing factor (See Table 1-13)
- C = Capacity in cubic feet per hour
- W = Weight of material, lbs. per cubic foot
- F<sub>f</sub> = Flight factor (See Table 1-14)
- F<sub>m</sub> = Material factor (See Table 1-2)
- F<sub>p</sub> = Paddle factor, when required. (See Table 1-15)
- F<sub>O</sub> = Overload factor (See Table 1-16)
- e = Drive efficiency (See Table 1-17)

**Table 1-12**

Conveyor Diameter Factor, F <sub>d</sub>			
Screw Diameter Inches	Factor F <sub>d</sub>	Screw Diameter Inches	Factor F <sub>d</sub>
4	12.0	14	78.0
6	18.0	16	106.0
9	31.0	18	135.0
10	37.0	20	165.0
12	55.0	24	235.0
		30	300

**Table 1-13**

Hanger Bearing Factor F <sub>b</sub>		
Bearing Type		Hanger Bearing Factor F <sub>b</sub>
B	Ball	1.0
L	<i>Martin</i> Bronze	2.0
S	*Graphite Bronze *Melamine *Oil Impreg. Bronze *Oil Impreg. Wood *Nylatron *Nylon *Teflon *UHMW  *Urethane	2.0
	* <i>Martin</i> Hard Iron	3.4
H	*Hard Surfaced *Stellite  * Ceramic	4.4

\*Non lubricated bearings, or bearings not additionally lubricated.





# Horsepower Factor Tables

**Table 1-14**  
Flight Factor,  $F_f$

Flight Type	$F_f$ Factor for Percent Conveyor Loading			
	15%	30%	45%	95%
Standard	1.0	1.0	1.0	1.0
Cut Flight	1.10	1.15	1.20	1.3
Cut & Folded Flight	N.R.*	1.50	1.70	2.20
Ribbon Flight	1.05	1.14	1.20	—
*Not Recommended				

**Table 1-15**

Paddle Factor $F_p$					
Standard Paddles per Pitch, Paddles Set at 45° Reverse Pitch					
Number of Paddles per Pitch	0	1	2	3	4
Paddle Factor — $F_p$	1.0	1.29	1.58	1.87	2.16

**Table 1-16**

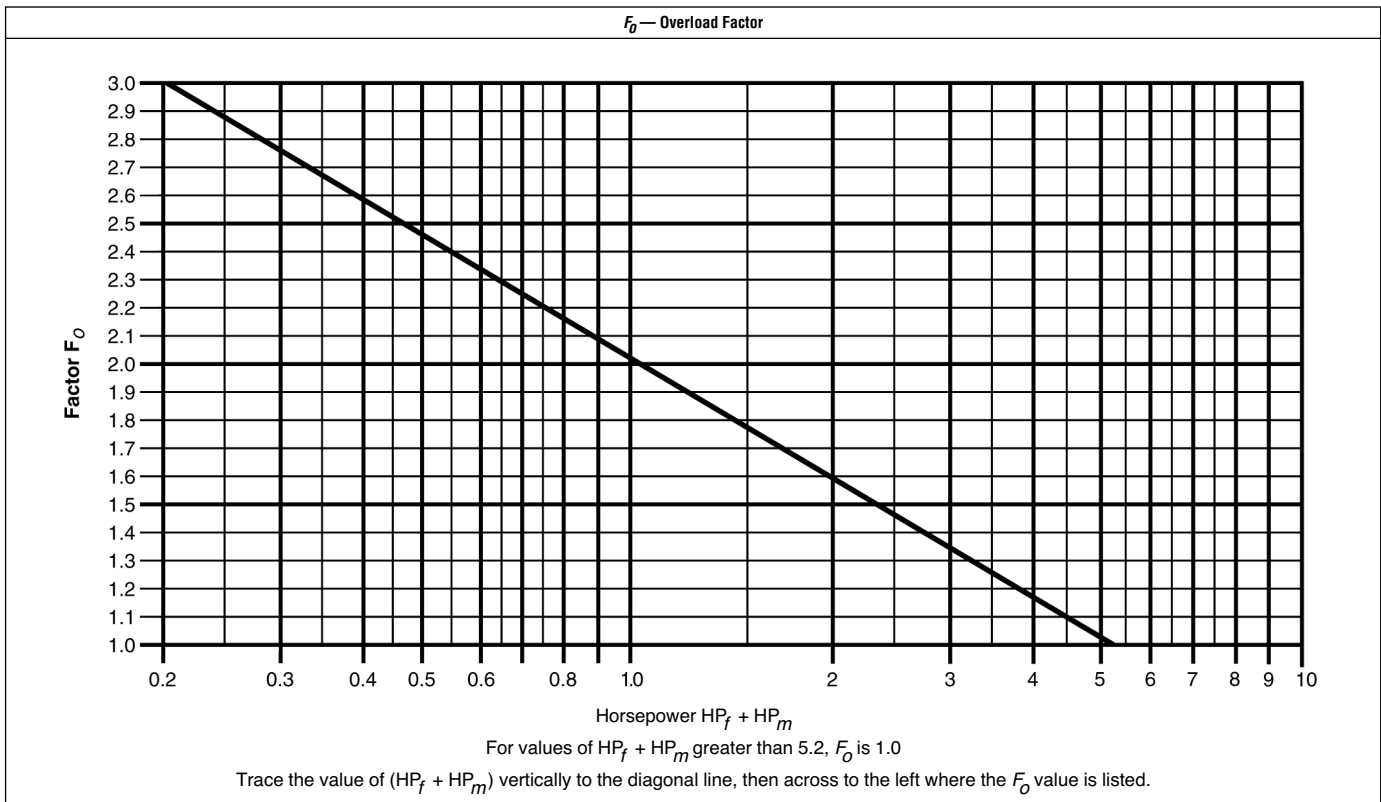

**Table 1-17**

e Drive Efficiency Factor				
Screw Drive or Shaft Mount w/ V-Belt Drive	V-Belt to Helical Gear and Coupling	Gearmotor w/ Coupling	Gearmotor w/ Chain Drive	Worm Gear
.88	.87	.95	.87	Consult Manufacturer

CONVEYORS

# Horsepower



**EXAMPLE:** Horsepower Calculation (See page H-50 for sample worksheet)

**PROBLEM:** Convey 1,000 cubic feet per hour Brewers grain, spent wet, in a 25'-0" long conveyor driven by a screw conveyor drive with V-belts.

**SOLUTION:**

1. Refer to material characteristic table 1-2 for Brewers grain, spent wet and find:
  - A. wt/cf: 55 - 60
  - B. material code: C½ - 45T  
Refer to Table 1-1, material classification code chart where:  
C½ = Fine ½" and under  
4 = Sluggish  
5 = Mildly abrasive  
T = Mildly corrosive
  - C. Intermediate bearing selection: L or S  
Refer to Table 1-11 Bearing Selection, Find:  
L = Bronze  
S = Nylatron, Nylon, Teflon, UHMW Melamine, Graphite Bronze, Oil-impreg. Bronze, and oil-impreg. wood and Urethane.
  - D. Material Factor:  $F_m = .8$
  - E. Trough Loading: 30%A  
Refer to Table 1-6 capacity table and find 30%A which shows the various capacities per RPM of the standard size screw conveyors and the maximum RPM's for those sizes.
2. From Table 1-6, Capacity table under 30%A note that a 12" screw will convey 1,160 cubic feet per hour at 90 RPM maximum, therefore at 1 RPM a 12" screw will convey 12.9 cubic feet. For 1,000 CFH capacity at 12.9 CFH per RPM, the conveyor must therefore run 78RPM ( $1000 \div 12.9 = 77.52$ ).
3. With the above information and factors from Tables 1-12 through 1-17 refer to the horsepower formulas on H-24 and calculate the required horsepower to convey 1000 CF/H for 25 feet in a 12" conveyor.

Using the known factors find that:

- |                                    |                                        |
|------------------------------------|----------------------------------------|
| L = 25'                            | C = 1000 CFH                           |
| N = 78 RPM from step 2 above       | W = 60#/CF from step 1A                |
| $F_d = 55$ see Table 1-12, for 12" | $F_f = 1$ see Table 1-14, standard 30% |
| $F_b = 2.0$ see Table 1-13 for L   | $F_p = 1$ see Table 1-15               |
|                                    | e = .88 see Table 1-17                 |

4. Solve the following horsepower equations:

A.  $HP_f = \frac{L N F_d F_b}{1,000,000} = \frac{25 \times 78 \times 55 \times 2.0}{1,000,000} = 0.215$

B.  $HP_m = \frac{C L W F_f F_m F_p}{1,000,000} = \frac{1000 \times 25 \times 60 \times 1 \times .8 \times 1}{1,000,000} = 1.2$

Find the  $F_o$  factor from 1-16; by adding  $HP_f$  and  $HP_m$  and matching this sum to the values on the chart.

C.  $HP_f = \frac{(HP_f + HP_m) (F_o)}{e} = \frac{(1.414) (1.9)}{.88} = 3.05$

**SOLUTION:** 3.05 Horsepower is required to convey 1,000 CFH Brewers grain, spent wet in a 12" conveyor for 25 feet. A 5 H.P. motor should be used.



# Torsional Ratings of Conveyor Screw Parts

Screw conveyors are limited in overall design by the amount of torque that can be safely transmitted through the pipes, couplings, and coupling bolts.

The table below combines the various torsional ratings of bolts, couplings and pipes so that it is easy to compare the torsional ratings of all the stressed parts of standard conveyor screws.

**Table 1-18**

Coupling	Pipe		Couplings		Bolts				
	Sch. 40		Torque in Lbs.*		Bolt Dia. In.	Bolts in Shear in Lbs. ▲		Bolts in Bearing in Lbs.	
	Size In.	Torque In. Lbs.				No. of Bolts Used		No. of Bolts Used	
			CEMA Std. (C-1018)	Martin (C-1045) Std.		2	3	2	3
1	1½	3,140	820	999	¾	1,380	2,070	1,970	2,955
1½	2	7,500	3,070	3,727	½	3,660	5,490	5,000	7,500
2	2½	14,250	7,600	9,233	⅝	7,600	11,400	7,860	11,790
2⅞	3	23,100	15,090	18,247	⅝	9,270	13,900	11,640	17,460
3	3½	32,100	28,370	34,427	¾	16,400	24,600	15,540	23,310
3	4	43,000	28,370	34,427	¾	16,400	24,600	25,000	37,500
3⅞	4	43,300	42,550	51,568	⅞	25,600	38,400	21,800	32,700

▲ Values shown are for A307-64, Grade 2 Bolts. Values for Grade 5 Bolts are above × 2.5  
 \*Values are for unheattreated shafts.

The lowest torsional rating figure for any given component will be the one that governs how much torque may be safely transmitted. For example, using standard unhardened two bolt coupling shafts, the limiting torsional strength of each part is indicated by the underlined figures in Table 1-18.

Thus it can be seen that the shaft itself is the limiting factor on 1", 1½" and 2" couplings. The bolts in shear are the limiting factors on the 2⅞" coupling and on the 3" coupling used in conjunction with 4" pipe. The bolts in bearing are the limiting factors for the 3" coupling used in conjunction with 3½" pipe, and for the 3⅞" coupling.

Formula: Horsepower To Torque (In. Lbs.)

$$\frac{63,025 \times \text{HP}}{\text{RPM}} = \text{Torque (In. Lbs.)}$$

**EXAMPLE:** 12" Screw, 78 RPM, 5 Horsepower

$$\frac{63,025 \times 5}{78} = 4,040 \text{ In. Lbs.}$$

From the table above 2" shafts with 2 bolt drilling and 2½" std. pipe are adequate (4,040 < 7600).

If the torque is greater than the values in the above table, such as in 2" couplings (torque > 7600), then hardened shafts can be used as long as the torque is less than the value for hardened couplings (torque < 9500). If the torque is greater than the 2 bolt in shear value but less than the 3 bolt in shear value then 3 bolt coupling can be used. The same applies with bolts in bearing. When the transmitted torque is greater than the pipe size value, then larger pipe or heavier wall pipe may be used. Other solutions include: high torque bolts to increase bolt in shear rating, external collars, or bolt pads welded to pipe to increase bolt in bearing transmission. For solutions other than those outlined in the above table please consult our Engineering Department.

CONVEYORS

# Horsepower Ratings of Conveyor Screw Parts



Screw conveyors are limited in overall design by the amount of horsepower that can be safely transmitted through the pipes, couplings, and coupling bolts.

The table below combines the various horsepower ratings of bolts, couplings and pipes so that it is easy to compare the ratings of all the stressed parts of standard conveyor screws.

**Table 1-19**

Coupling	Pipe		Couplings		Bolts				
Shaft Dia. In.	Size In.	H.P. per R.P.M.	H.P. per R.P.M.		Bolt Dia. In.	Bolts in Shear H.P. per R.P.M. ▲		Bolts in Bearing H.P. per R.P.M.	
			CEMA Std. (C-1018)	Martin (C-1045) Std.		No. of Bolts Used		No. of Bolts Used	
						2	3	2	3
1	1¼	.049	.013	.016	¾	.021	.032	.031	.046
1½	2	.119	.048	.058	½	.058	.087	.079	.119
2	2½	.226	.120	.146	⅝	.120	.180	.124	.187
2⅞	3	.366	.239	.289	⅝	.147	.220	.184	.277
3	3½	.509	.450	.546	¾	.260	.390	.246	.369
3	4	.682	.450	.546	¾	.260	.390	.396	.595
3⅞	4	.682	.675	.818	⅞	.406	.609	.345	.518

▲ Values shown are for A307-64, Grade 2 Bolts.

The lowest horsepower rating figure for any given component will be the one that governs how much horsepower may be safely transmitted. The limiting strength of each part is indicated by the underlined figures in the table above.

Formula: Horsepower To Horsepower @ 1 RPM

**EXAMPLE:** 12" Screw, 78 RPM, 5 Horsepower

$$\frac{5 \text{ HP}}{78 \text{ RPM}} = 0.06 \text{ HP at 1 RPM}$$

From the table above .038 is less than the lowest limiting factor for 2" couplings, so 2" standard couplings with 2 bolts may be used. Solutions to limitations are the same as shown on H-27.



## Screw Conveyor End Thrust Thermal Expansion

End thrust in a Screw Conveyor is created as a reaction to the forces required to move the material along the axis of the conveyor or trough. Such a force is opposite in direction to the flow of material. A thrust bearing and sometimes reinforcement of the conveyor or trough is required to resist thrust forces. Best performance can be expected if the conveyor end thrust bearing is placed so that the rotating members are in tension; therefore, an end thrust bearing should be placed at the discharge end of a conveyor. Placing an end thrust bearing assembly at the feed end of a conveyor places rotating members in compression which may have undesirable effects, but this is sometimes necessary in locating equipment.

There are several methods of absorbing thrust forces, the most popular methods are:

1. Thrust washer assembly — installed on the shaft between the pipe end and the trough end plate, or on the outside of the end bearing.
2. Type "E" end thrust assembly, which is a Double Roller Bearing and shaft assembly.
3. Screw Conveyor Drive Unit, equipped with double roller bearing thrust bearings, to carry both thrust and radial loads.

Past experience has established that component selection to withstand end thrust is rarely a critical factor and thrust is not normally calculated for design purposes. Standard conveyor thrust components will absorb thrust without resorting to special design in most applications.

### Expansion of Screw Conveyors Handling Hot Materials

Screw conveyors often are employed to convey hot materials. It is therefore necessary to recognize that the conveyor will increase in length as the temperature of the trough and screw increases when the hot material begins to be conveyed.

The recommended general practice is to provide supports for the trough which will allow movement of the trough end feet during the trough expansion, and during the subsequent contraction when handling of the hot material ceases. The drive end of the conveyor usually is fixed, allowing the remainder of the trough to expand or contract. In the event there are intermediate inlets or discharge spouts that cannot move, the expansion type troughs are required.

Furthermore, the conveyor screw may expand or contract in length at different rates than the trough. Therefore, expansion hangers are generally recommended. The trough end opposite the drive should incorporate an expansion type ball or roller bearing or sleeve bearing which will safely provide sufficient movement.

The change in screw conveyor length may be determined from the following formula:

$$\Delta L = L (t_1 - t_2) C$$

Where:  $\Delta L$  = increment of change in length, inch

$L$  = overall conveyor length in inches

$t_1$  = upper limit of temperature, degrees Fahrenheit

$t_2$  = limit of temperature, degrees Fahrenheit,  
(or lowest ambient temperature expected)

$C$  = coefficient of linear expansion, inches per inch per degree Fahrenheit. This coefficient has the following values for various metals:

(a) Hot rolled carbon steel,  $6.5 \times 10^{-6}$ , (.0000065)

(b) Stainless steel,  $9.9 \times 10^{-6}$ , (.0000099)

(c) Aluminum,  $12.8 \times 10^{-6}$ , (.0000128)

#### EXAMPLE:

A carbon steel screw conveyor 30 feet overall length is subject to a rise in temperature of 200°F, reaching a hot metal temperature of 260°F from an original metal temperature of 60°F.

$$t_1 = 260 \quad t_1 - t_2 = 200$$

$$t_2 = 60$$

$$L = (30) (12) = 360$$

$$\Delta L = (360) (200) (6.5 \times 10^{-6})$$

$$= 0.468 \text{ inches, or about } \frac{15}{32} \text{ inches.}$$

# Conveyor Screw Deflection



When using conveyor screws of standard length, deflection is seldom a problem. However, if longer than standard sections of screw are to be used, without intermediate hanger bearings, care should be taken to prevent the screw flights from contacting the trough because of excessive deflection. The deflection at mid span may be calculated from the following formula.

$$D = \frac{5WL^3}{384 (29,000,000) (I)}$$

Where: D = Deflection at mid span in inches

W = Total screw weight in pounds, see pages H-81 to H-83

L = Screw length in inches

I = Movement of inertia of pipe or shaft, see table 1-20 or 1-21 below

**Table 1-20 Schedule 40 Pipe**

Pipe Size	2"	2½"	3"	3½"	4"	5"	6"	8"	10"
I	.666	1.53	3.02	4.79	7.23	15.2	28.1	72.5	161

**Table 1-21 Schedule 80 Pipe**

Pipe Size	2"	2½"	3"	3½"	4"	5"	6"	8"	10"
I	.868	1.92	3.89	6.28	9.61	20.7	40.5	106	212

**EXAMPLE:** Determine the deflection of a 12H512 screw conveyor section mounted on 3" sch 40 pipe, overall length is 16'-0".

W = 272#

L = 192"

I = 3.02 (From chart above)

$$D = \frac{5 (272\#) (192^3)}{384 (29,000,000) (3.02)} = .29 \text{ inches}$$

Applications where the calculated deflection of the screw exceeds .25 inches (¼") should be referred to our Engineering Department for recommendations. Very often the problem of deflection can be solved by using a conveyor screw section with a larger diameter pipe or a heavier wall pipe. Usually, larger pipe sizes tend to reduce deflection more effectively than heavier wall pipe.

CONVEYORS



# Conveyor Screw Deflection

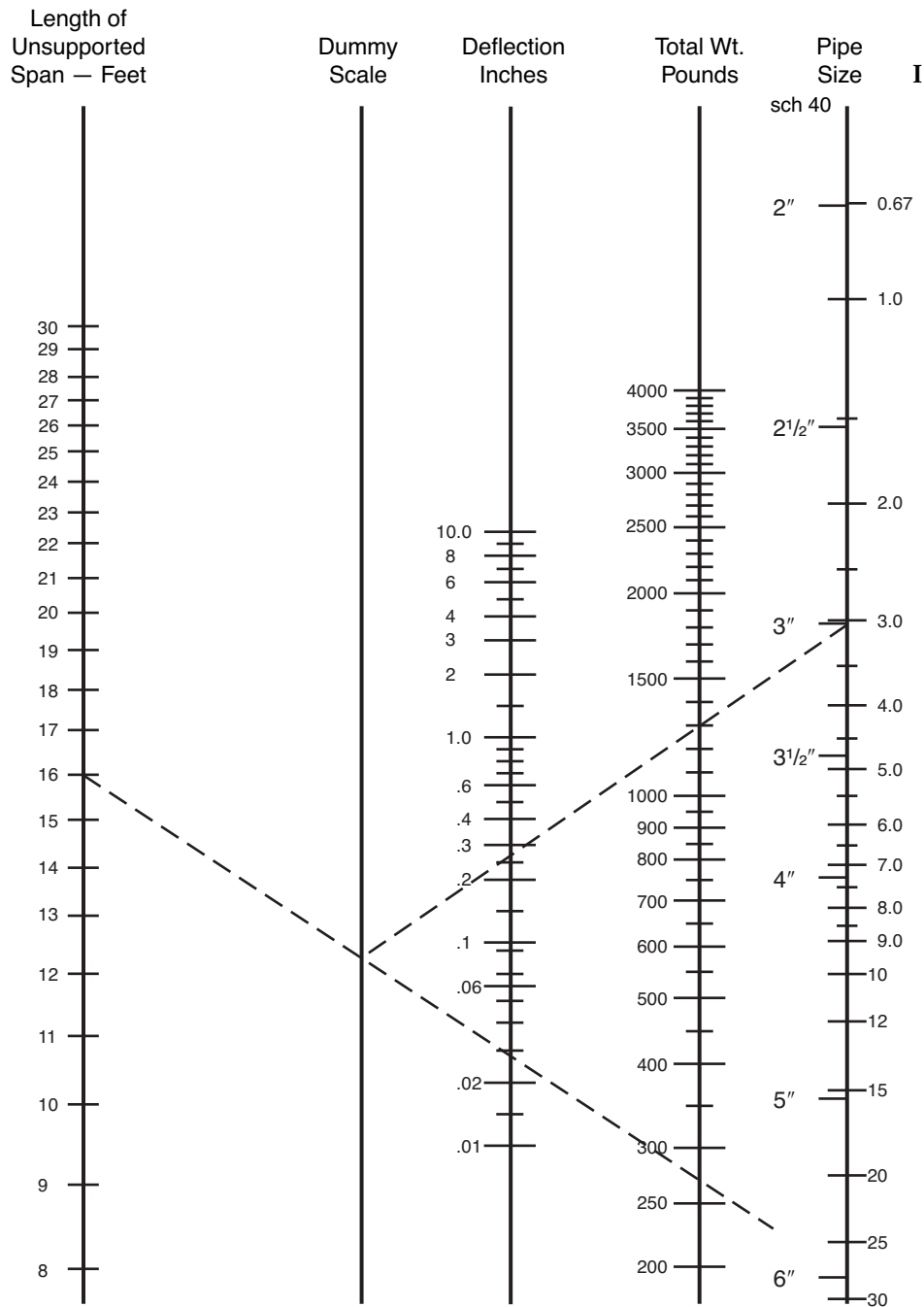

I = Moment of inertia of pipe or shaft, see Table 1-20 or 1-21

The above Nomograph can be used for a quick reference to check deflection of most conveyors.

CONVEYORS

# Inclined and Vertical Screw Conveyors

*Martin*

Inclined  
Screw  
Conveyors

Inclined screw conveyors have a greater horsepower requirement and a lower capacity rating than horizontal conveyors. The amounts of horsepower increase and capacity loss depend upon the angle of incline and the characteristics of the material conveyed.

Inclined conveyors operate most efficiently when they are of tubular or shrouded cover design, and a minimum number of intermediate hanger bearings. Where possible, they should be operated at relatively high speeds to help prevent fallback of the conveyed material.

Consult our Engineering Department for design recommendations and horsepower requirements for your particular application.

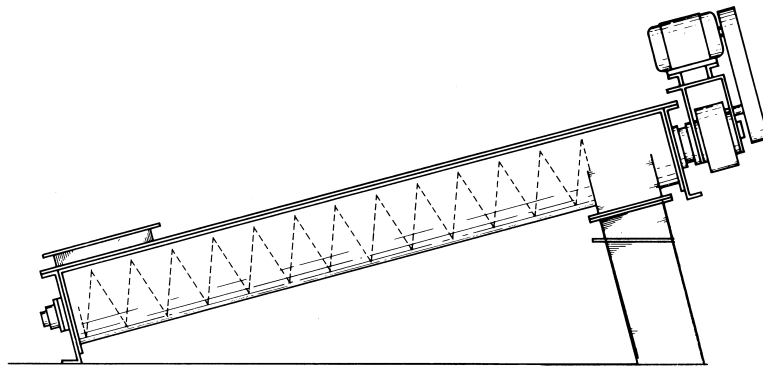

Vertical screw conveyors provide an efficient method of elevating most materials that can be conveyed in horizontal screw conveyors. Since vertical conveyors must be uniformly loaded in order to prevent choking, they are usually designed with integral feeders.

As with horizontal conveyors, vertical screw conveyors are available with many special features and accessories, including components of stainless steel or other alloys.

Consult our Engineering Department for design recommendations and horsepower requirements for your particular application.

SEE VERTICAL SCREW CONVEYOR SECTION OF CATALOG FOR ADDITIONAL INFORMATION.

Vertical  
Screw  
Conveyors

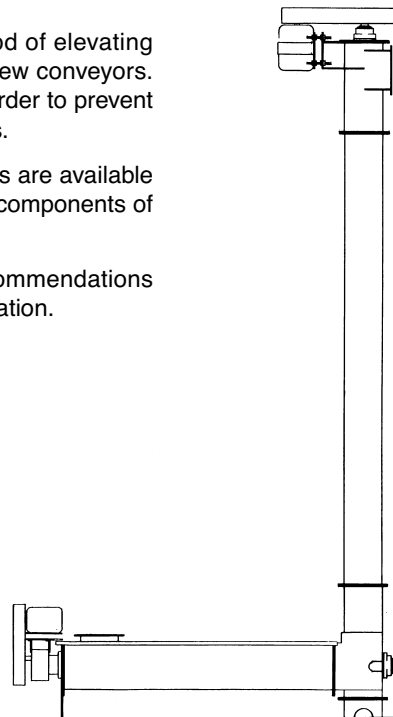

CONVEYORS



The logo for Martin, featuring the word "Martin" in a white, cursive script font on a black rectangular background.

## Screw Feeders

Screw Feeders are designed to regulate the rate of material flow from a hopper or bin. The inlet is usually flooded with material (95% loaded). One or more tapered or variable pitch screws convey the material at the required rate. Screw feeders are regularly provided with shrouded or curved cover plates for a short distance beyond the end of the inlet opening, to obtain feed regulation. As the pitch or diameter increases beyond the shroud the level of the material in the conveyor drops to normal loading levels. Longer shrouds, extra short pitch screws and other modifications are occasionally required to reduce flushing of very free flowing material along the feeder screw.

Feeders are made in two general types: Type 1 with regular pitch flighting and Type 2 with short pitch flighting. Both types are also available with uniform diameter and tapering diameter screws. The various combinations are shown on pages H-34–H-35. Screw feeders with uniform screws, Types 1B, 1D, 2B, 2D are regularly used for handling fine free flowing materials. Since the diameter of the screw is uniform, the feed of the material will be from the forepart of the inlet and not across the entire length. Where hoppers, bins, tanks, etc. are to be completely emptied, or dead areas of material over the inlet are not objectionable, this type of feeder is entirely satisfactory, as well as economical. Screw feeders with tapering diameter screws will readily handle materials containing a fair percentage of lumps. In addition, they are used extensively where it is necessary or desirable to draw the material uniformly across the entire length of the inlet opening to eliminate inert or dead areas of material at the forepart of the opening. Types 1A, 1C, 2A, and 2C fall into this category. Variable pitch screws can be used in place of tapering diameter screws for some applications. They consist of screws with succeeding sectional flights increasing progressively in pitch. The portion of the screw with the smaller pitch is located under the inlet opening.

Screw feeders with extended screw conveyors are necessary when intermediate hangers are required, or when it is necessary to convey the material for some distance. A screw conveyor of larger diameter than the feeder screw is combined with the feeder to make the extension. See types 1C, 1D, 2C, 2D.

Multiple screw feeders are usually in flat bottom bins for discharging material which have a tendency to pack or bridge under pressure. Frequently, the entire bin bottom is provided with these feeders which convey the material to collecting conveyors. Such arrangements are commonly used for handling hogged fuel, wood shavings, etc.

Screw feeders are available in a variety of types to suit specific materials and applications. We recommend that you contact our Engineering Department for design information.

# Screw Feeders

(For Inclined Applications Consult Factory)

## Typical Type 1

Feeder Type	Inlet Opening	Material Removal	Pitch	Feeder Screw Diameter	Extended Screw
SF1A	Standard	Uniform Full Length of Inlet Opening	Standard	Tapered	None
SF1B	Standard	Forepart Only of Inlet Opening	Standard	Uniform	None
SF1C	Standard	Uniform Full Length of Inlet Opening	Standard	Tapered	As Required
SF1D	Standard	Forepart Only of Inlet Opening	Standard	Uniform	As Required

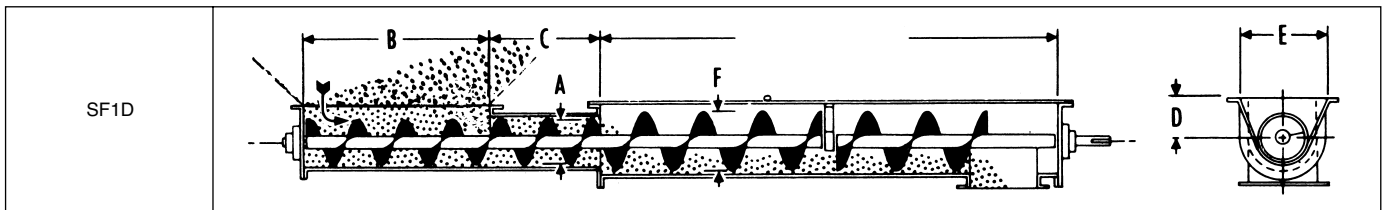
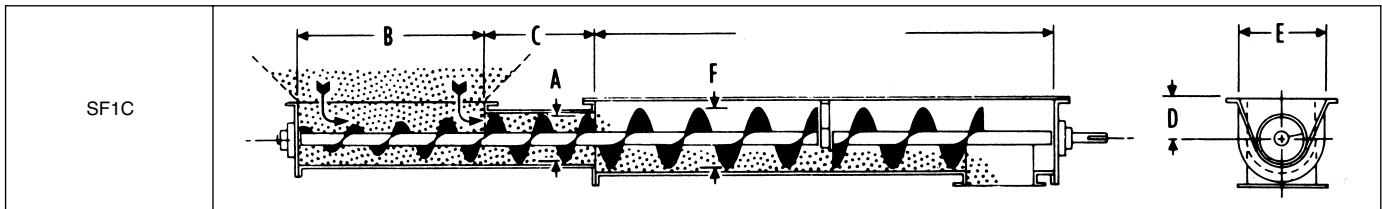
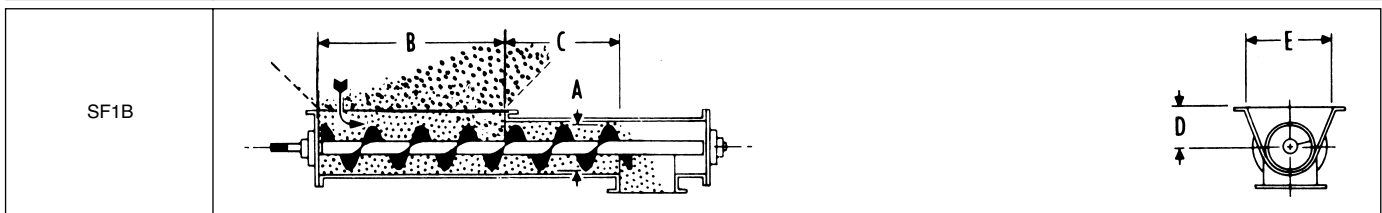
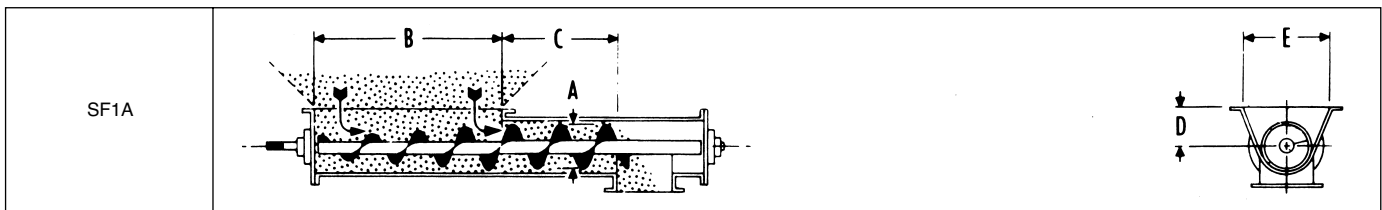

CONVEYORS

Feeder Diameter A	Maximum Lump Size	Maximum Speed RPM	Capacity Cubic Feet per Hour		B	C	D	E	Extended Screw Diameter F		
			At One RPM	At Maximum RPM					Trough Loading %		
									15	30	45
6	3/4"	70	4.8	336	36	12	7	14	12	9	9
9	1 1/2"	65	17	1105	42	18	9	18	18	14	12
12	2"	60	44	2640	48	24	10	22	24	18	16
14	2 1/2"	55	68	3740	54	28	11	24		20	18
16	3"	50	104	5200	56	32	11 1/2	28		24	20
18	3"	45	150	6750	58	36	12 1/2	31			24
20	3 1/2"	40	208	8320	60	40	13 1/2	34			
24	4"	30	340	10200	64	48	16 1/2	40			

\*Consult factory if inlet exceeds these lengths.



# Screw Feeders

(For Inclined Applications Consult Factory)

## Typical Type 2

Feeder Type	Inlet Opening	Material Removal	Pitch	Feeder Screw Diameter	Extended Screw
SF2A	Long	Uniform Full Length of Inlet Opening	Short (%)	Tapered	None
SF2B	Long	Forepart Only of Inlet Opening	Short (%)	Uniform	None
SF2C	Long	Uniform Full Length of Inlet Opening	Short (%)	Tapered	As Required
SF2D	Long	Forepart Only of Inlet Opening	Short (%)	Uniform	As Required

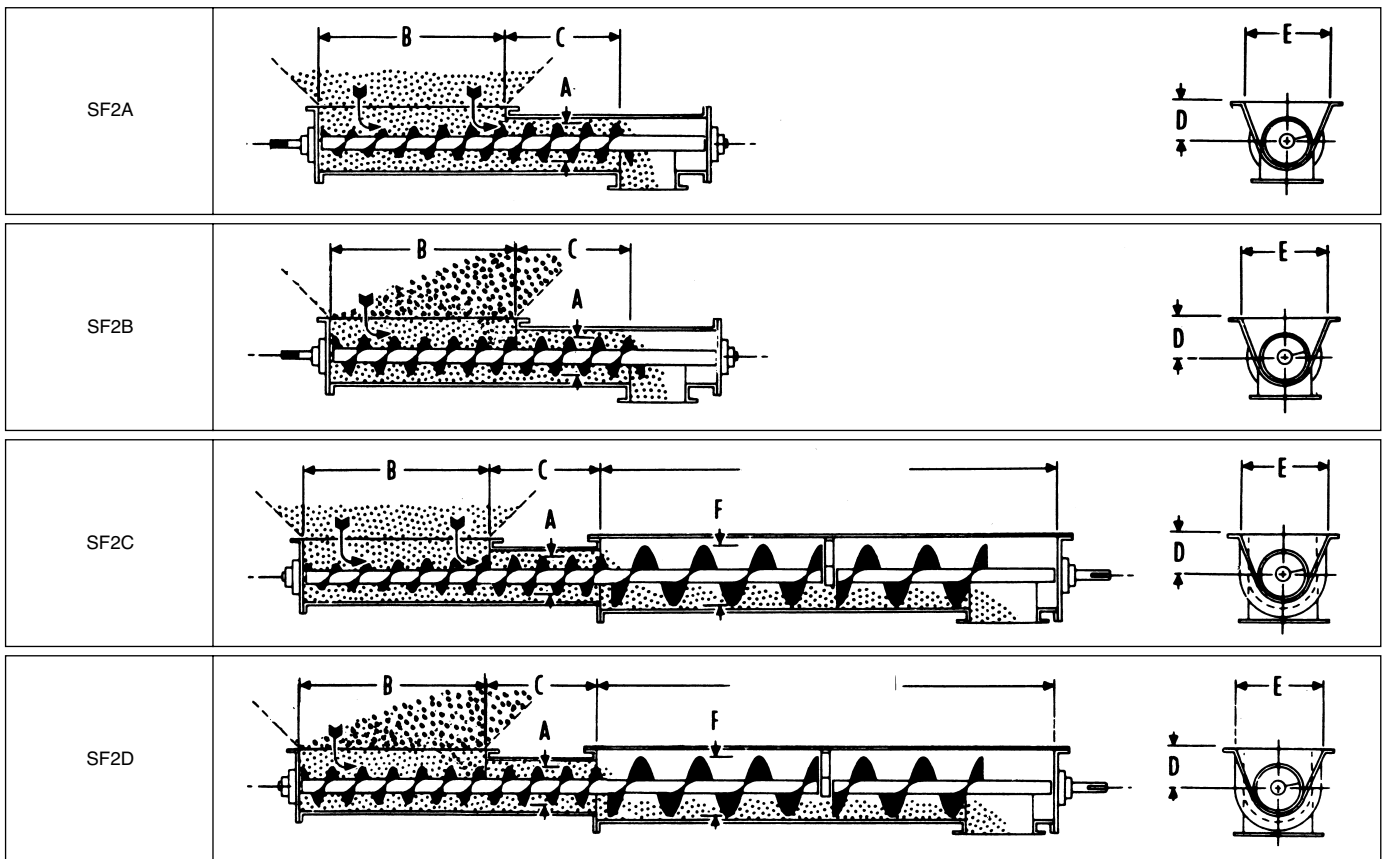

Feeder Diameter A	Maximum Lump Size	Maximum Speed RPM	Capacity Cubic Feet per Hour		B	C	D	E	Extended Screw Diameter F		
			At One RPM	At Maximum RPM					Trough Loading %		
									15	30	45
6	1/2"	70	3.1	217	60	18	7	14	10	9	9
9	3/4"	65	11	715	66	26	9	18	14	12	10
12	1"	60	29	1740	72	36	10	22	20	16	14
14	1 1/4"	55	44	2420	76	42	11	24	24	18	16
16	1 1/2"	50	68	3400	78	48	11 1/2	28		20	18
18	1 3/4"	45	99	4455	80	54	12 1/2	31		24	20
20	2"	40	137	5480	82	60	13 1/2	34			24
24	2 1/2"	30	224	6720	86	72	16 1/2	40			

CONVEYORS

# Design and Layout



## SECTION II

### DESIGN AND LAYOUT SECTION II

Classification of Enclosure Types .....	H-36
Hand of Conveyors .....	H-38
Classification of Special Continuous Weld Finishes .....	H-39
Detailing of “U” Trough .....	H-40
Detailing of Tubular Trough .....	H-41
Detailing of Trough and Discharge Flanges .....	H-42
Bolt Tables .....	H-44
Pipe Sizes and Weights .....	H-46
Screw Conveyor Drive Arrangements .....	H-47
Standards Helicoid Screw .....	H-48
Standards Butt weld Screw .....	H-49
Screw Conveyor Sample Horsepower Worksheet .....	H-50

### Classes of Enclosures

Conveyors can be designed to protect the material being handled from a hazardous surrounding or to protect the surroundings from a hazardous material being conveyed.

This section establishes recommended classes of construction for conveyor enclosures — without regard to their end use or application. These several classes call for specific things to be done to a standard conveyor housing to provide several degrees of enclosure protection.

### Enclosure Classifications

- Class IE — Class IE enclosures are those provided primarily for the protection of operating personnel or equipment, or where the enclosure forms an integral or functional part of the conveyor or structure. They are generally used where dust control is not a factor or where protection for, or against, the material being handled is not necessary — although as conveyor enclosures a certain amount of protection is afforded.
- Class IIE — Class IIE enclosures employ constructions which provide some measure of protection against dust or for, or against, the material being handled.
- Class IIIE — Class IIIE enclosures employ constructions which provide a higher degree of protection in these classes against dust, and for or against the material being handled.
- Class IVE — Class IVE enclosures are for outdoor applications and under normal circumstances provide for the exclusion of water from the inside of the casing. They are not to be construed as being water-tight, as this may not always be the case.

When more than one method of fabrication is shown, either is acceptable.



# Enclosures

Enclosure Construction				
Component Classification	Enclosure Classifications			
	I E	II E	III E	IV E
<b>A. TROUGH CONSTRUCTION</b>				
Formed & Angle Top Flange				
1. Plate type end flange				
a. Continuous arc weld .....	X	X	X	X
b. Continuous arc weld on top of end flange and trough top rail .....	X	X	X	X
2. Trough Top Rail Angles (Angle Top trough only)				
a. Staggered intermittent arc and spot weld .....	X			
b. Continuous arc weld on top leg of angle on inside of trough and intermittent arc weld on lower leg of angle to outside of trough .....		X	X	X
c. Staggered intermittent arc weld on top leg of angle on inside of trough and intermittent arc weld on lower leg of angle to outside of trough, or spot weld when mastic is used between leg of angle and trough sheet .....		X	X	X
<b>B. COVER CONSTRUCTION</b>				
1. Plain flat				
a. Only butted when hanger is at cover joint .....	X			
b. Lapped when hanger is not at cover joint .....	X			
2. Semi-Flanged				
a. Only butted when hanger is at cover joint .....	X	X	X	X
b. Lapped when hanger is not at cover joint .....	X			
c. With buttstrap when hanger is not at cover joint .....		X	X	X
3. Flanged				
a. Only butted when hanger is at cover joint .....		X	X	X
b. Buttstrap when hanger is not at cover joint .....		X	X	X
4. Hip Roof				
a. Ends with a buttstrap connection .....				X
<b>C. COVER FASTENERS FOR STANDARD GA. COVERS</b>				
1. Spring, screw or toggle clamp fasteners or bolted construction*				
a. Max. spacing plain flat covers .....	60"			
b. Max. spacing semi-flanged covers .....	60"	30"	18"	18"
c. Max. spacing flanged and hip-roof covers .....		40"	24"	24"
<b>D. GASKETS</b>				
1. Covers				
a. Red rubber or felt up to 230° F .....		X	X	
b. Neoprene rubber, when contamination is a problem .....		X	X	
c. Closed cell foam type elastic material to suit temperature rating of gasket .....		X	X	X
2. Trough End flanges				
a. Mastic type compounds .....		X	X	X
b. Red rubber up to 230° F .....		X	X	X
c. Neoprene rubber, when contamination is a problem .....		X	X	
d. Closed cell foam type elastic material to suit temperature rating of gasket .....		X	X	X
<b>E. TROUGH END SHAFT SEALS*</b>				
1. When handling non-abrasive materials .....			X	X
2. When handling abrasive materials .....	X	X	X	X
*Lip type seals for non-abrasive materials Felt type for mildly abrasive materials Waste type for highly abrasive materials Waste type for moderately abrasive Air purged <i>Martin</i> Super Pac for extremely abrasive Bulk Heads may be required for abrasive & hot materials				
NOTE: CHECK MATERIAL TEMPERATURE.				

CONVEYORS

# Hand Conveyors

*Martin*

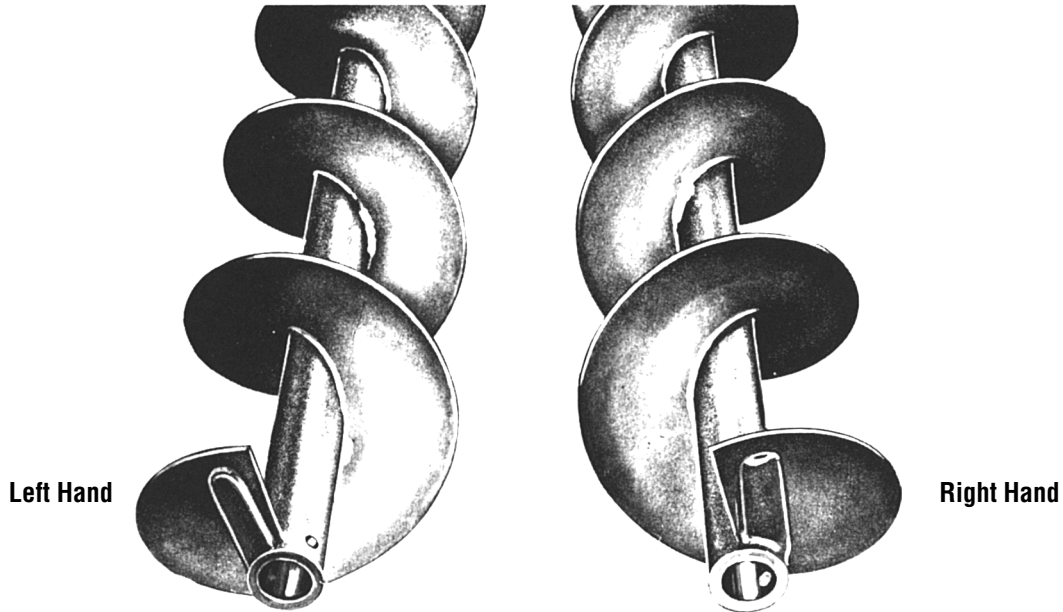

## Right and Left Hand Screws

A conveyor screw is either right hand or left hand depending on the form of the helix. The hand of the screw is easily determined by looking at the end of the screw.

The screw pictured to the left has the flight helix wrapped around the pipe in a counter-clockwise direction, or to your left. Same as left hand threads on a bolt. This is arbitrarily termed a LEFT hand screw.

The screw pictured to the right has the flight helix wrapped around the pipe in a clockwise direction, or to your right. Same as right hand threads on a bolt. This is termed a RIGHT hand screw.

A conveyor screw viewed from either end will show the same configuration. If the end of the conveyor screw is not readily visible, then by merely imagining that the flighting has been cut, with the cut end exposed, the hand of the screw may be easily determined.

## Conveyor Screw Rotation

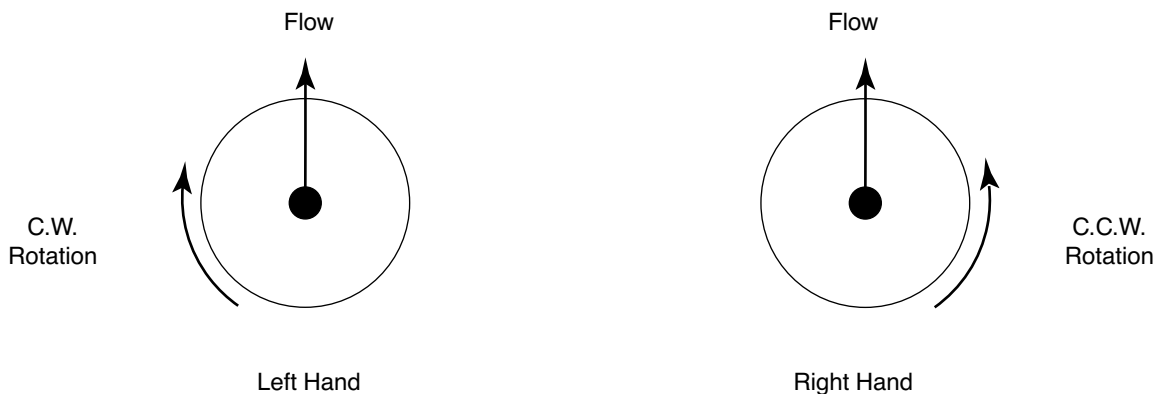

The above diagrams are a simple means of determining screw rotation. When the material flow is in the direction away from the end being viewed, a R.H. screw will turn counter clockwise and a L.H. screw will turn clockwise rotation as shown by the arrows.



# Conveyor Screw Rotation

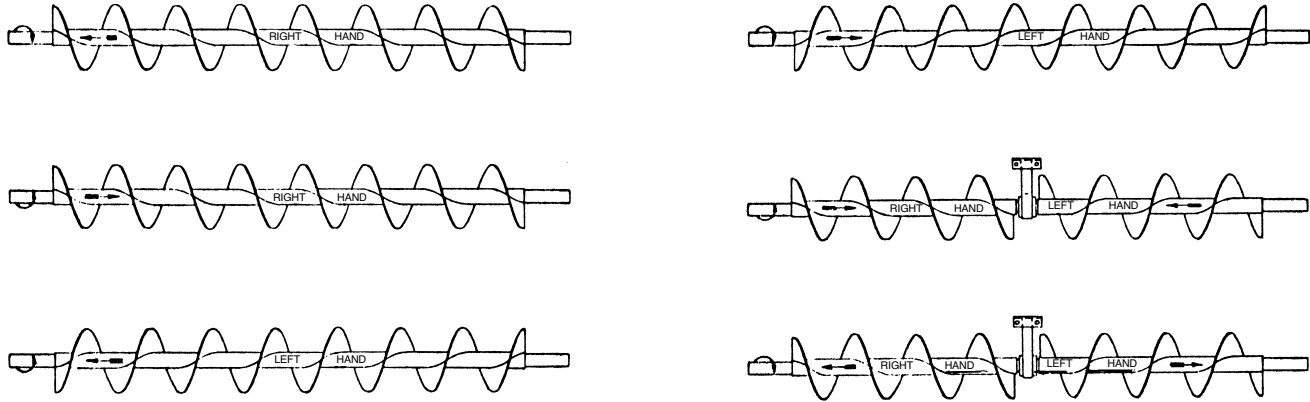

The above diagram indicates the hand of conveyor screw to use when direction of rotation and material flow are known.

## Special Screw Conveyor Continuous Weld Finishes

Specifications on screw conveyor occasionally include the term “grind smooth” when referring to the finish on continuous welds. This specification is usually used for stainless steel, but occasionally it will appear in carbon steel specifications as well.

“Grind smooth” is a general term and subject to various interpretations. This Table establishes recommended classes of finishes, which should be used to help find the class required for an application.

Operation	Weld Finishes				
	I	II	III	IV	V
Weld spatter and slag removed	X	X	X	X	X
Rough grind welds to remove heavy weld ripple or unusual roughness (Equivalent to a 40-50 grit finish)		X			
Medium grind welds — leaving some pits and crevices (Equivalent to a 80-100 grit finish)			X		
Fine grind welds — no pits or crevices permissible (Equivalent to a 140-150 grit finish)				X	X
Polish to a bright uniform finish					X

CONVEYORS

# Layout



## Trough

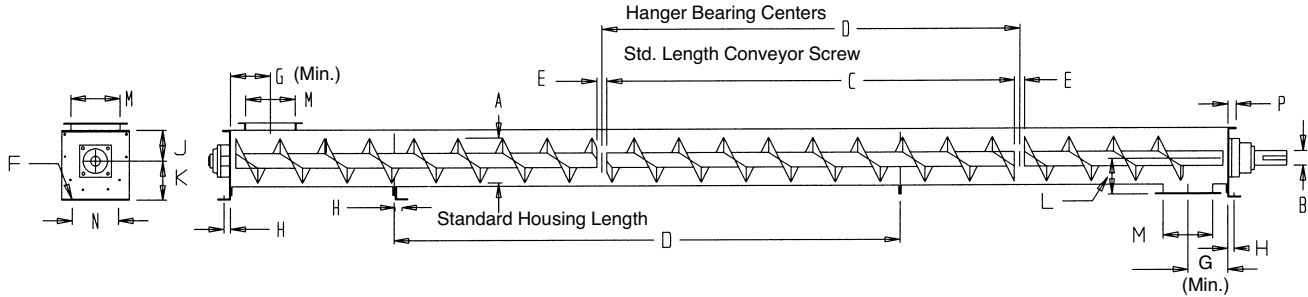

A Screw Diameter	B Coupling Diameter	C Length	D Length	E	F	G (Min.)	H	J	K	L	M	N	P	R
4	1	9-10½	10	1½	¾	4½	7⁄8	3¾	4¾	3¾	5	5¾	17⁄16	1
6	1½	9-10	10	2	¾	6	15⁄16	4½	5¾	5	7	8¾	1½	1
9	1½ 2	9-10	10	2	½	8	1⅞	6¾	7¾	7¾	10	9¾	1¾	1½
10	1½ 2	9-10	10	2	½	9	1⅞	6¾	8¾	7¾	11	9½	1¾	1¾
12	2 2⅞ 3	11-10 11-9 11-9	12	2 3 3	¾	10½	1¾	7¾	9¾	8¾	13	12¼	2	1¾
14	2⅞ 3	11-9	12	3	¾	11½	1¾	9¾	10¾	10¾	15	13½	2	1¾
16	3	11-9	12	3	¾	13½	1¾	10¾	12	11¾	17	14¾	2½	2
18	3 3⅞	11-9 11-8	12	3 4	¾	14½	1¾	12¾	13¾	12¾	19	16	2½	2
20	3 3⅞	11-9 11-8	12	3 4	¾	15½	2	13¾	15	13¾	21	19¾	2½	2¼
24	3⅞	11-8	12	4	¾	17½	2¼	16¾	18¾	15¾	25	20	2½	2½

Screw clearance at trough end is one half of dimension E

## Typical Method of Detailing

9" x 2" x 25'-0" Conveyor

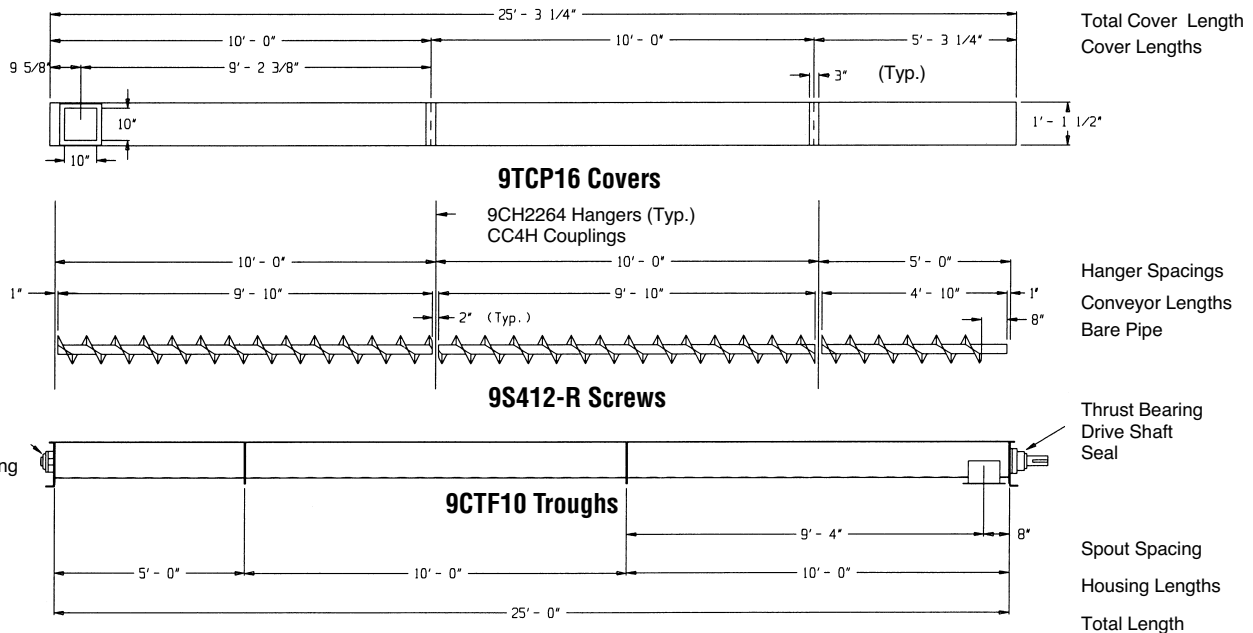

CONVEYORS





# Layout

## Tubular Housing

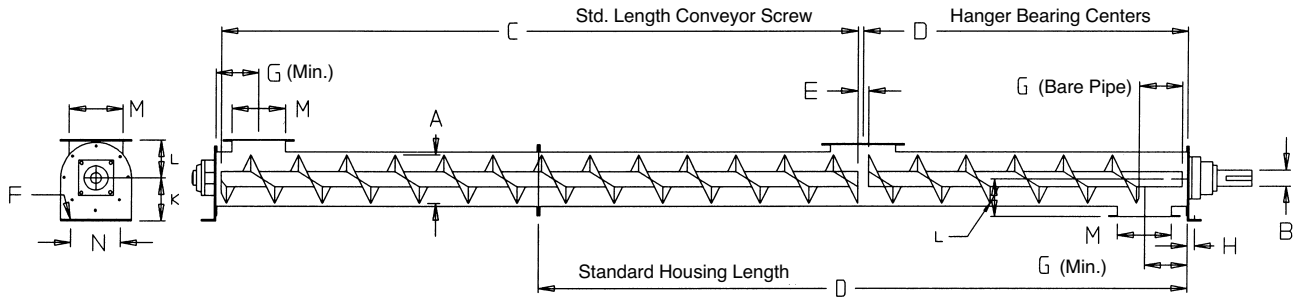

A Screw Dia.	B Coupling Dia.	C Length	D Length	E	F	G (Min.)	H	J	K	L	M	N	P	R
4	1	9-10½	10	1½	¾	4½	7⁄8	3¾	4¾	3¾	5	5¾	17⁄16	1
6	1½	9-10	10	2	¾	6	15⁄16	4½	5¾	5	7	8¾	1½	1
9	1½ 2	9-10	10	2	½	8	1¼	6¾	7¾	7¾	10	9¾	1¾	1½
10	1½ 2	9-10	10	2	½	9	1¼	6¾	8¾	7¾	11	9½	1¾	1¾
12	2 2⅞ 3	11-10 11-9 11-9	12	2 3 3	¾	10½	1¾	7¾	9¾	8¾	13	12¼	2	1¾
14	2⅞ 3	11-9	12	3	¾	11½	1¾	9¾	10¾	10¾	15	13½	2	1¾
16	3	11-9	12	3	¾	13½	1¾	10¾	12	11¾	17	14¾	2½	2
18	3 3⅞	11-9 11-8	12	3 4	¾	14½	1¾	12¾	13¾	12¾	19	16	2½	2
20	3 3⅞	11-9 11-8	12	3 4	¾	15½	2	13¾	15	13¾	21	19¾	2½	2¼
24	3⅞	11-8	12	4	¾	17½	2¼	16¾	18¾	15¾	25	20	2½	2½

Screw clearance at trough end is one half of dimension E

## Typical Method of Detailing

9" x 2" x 15'-0" Conveyor

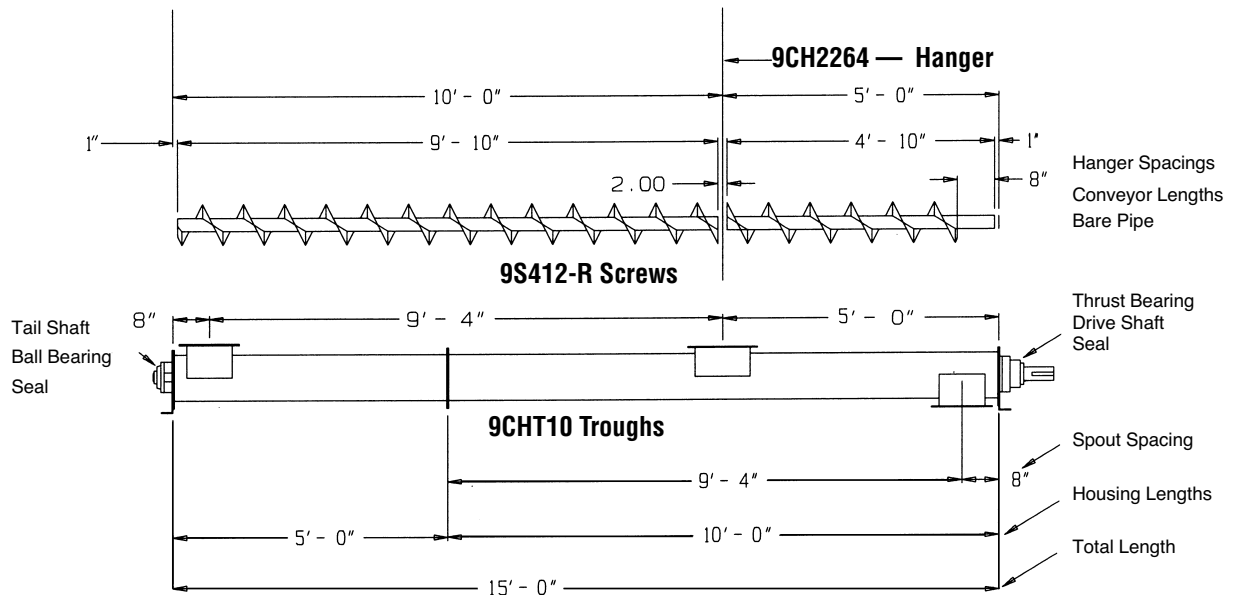

CONVEYORS

# Bolt Patterns



## U-Trough End Flanges

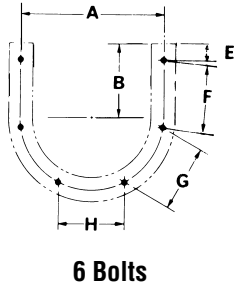

6 Bolts

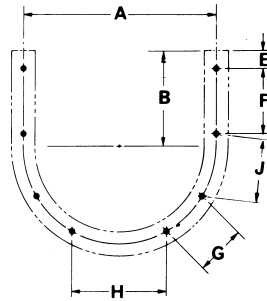

8 Bolts

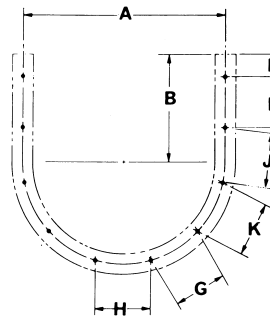

10 Bolts

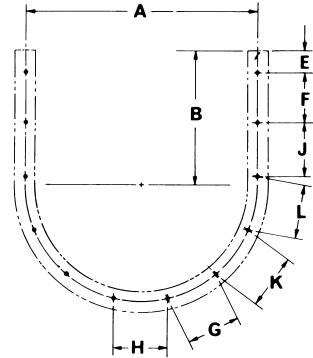

12 Bolts

Screw Diameter	Bolts		A	B	E	F	G	H	J	K	L
	Number	Diameter									
4	6	$\frac{3}{8}$	7	$3\frac{3}{8}$	$1\frac{1}{8}$	$3\frac{3}{8}$	$3\frac{3}{8}$	$3\frac{3}{8}$	X	X	X
6	6	$\frac{3}{8}$	$8\frac{7}{8}$	$4\frac{1}{2}$	$1\frac{1}{32}$	$4\frac{1}{8}$	$4\frac{1}{16}$	$4\frac{1}{16}$	X	X	X
9	8	$\frac{3}{8}$	$12\frac{1}{2}$	$6\frac{1}{8}$	$1\frac{3}{16}$	$4\frac{1}{8}$	$3\frac{3}{4}$	$5\frac{1}{8}$	$4\frac{1}{8}$	X	X
10	8	$\frac{3}{8}$	$13\frac{1}{4}$	$6\frac{3}{8}$	$2\frac{1}{4}$	$3\frac{1}{2}$	$4\frac{3}{16}$	$5\frac{1}{16}$	$4\frac{1}{8}$	X	X
12	8	$\frac{1}{2}$	$15\frac{5}{8}$	$7\frac{3}{4}$	$1\frac{1}{2}$	$5\frac{5}{16}$	$4\frac{1}{16}$	$7\frac{3}{4}$	$5\frac{3}{16}$	X	X
14	8	$\frac{1}{2}$	$17\frac{7}{8}$	$9\frac{1}{4}$	$2\frac{17}{32}$	$5\frac{1}{8}$	$5\frac{1}{16}$	6	$5\frac{1}{16}$	X	X
16	8	$\frac{5}{8}$	20	$10\frac{5}{8}$	$2\frac{3}{8}$	$6\frac{3}{8}$	$6\frac{3}{8}$	$7\frac{1}{2}$	$6\frac{3}{8}$	X	X
18	10	$\frac{5}{8}$	22	$12\frac{1}{4}$	$2\frac{29}{32}$	$5\frac{1}{16}$	$5\frac{1}{8}$	$5\frac{1}{8}$	$5\frac{1}{8}$	$5\frac{1}{8}$	X
20	10	$\frac{5}{8}$	$24\frac{3}{8}$	$13\frac{1}{2}$	$2\frac{25}{32}$	$6\frac{1}{4}$	$6\frac{1}{16}$	$6\frac{1}{16}$	$6\frac{1}{16}$	$6\frac{1}{16}$	X
24	12	$\frac{5}{8}$	$28\frac{1}{2}$	$16\frac{1}{2}$	$2\frac{25}{32}$	$6\frac{1}{8}$	$6\frac{3}{8}$	$6\frac{3}{8}$	$6\frac{3}{8}$	$6\frac{3}{8}$	$6\frac{3}{8}$

## Flared Trough End Flanges

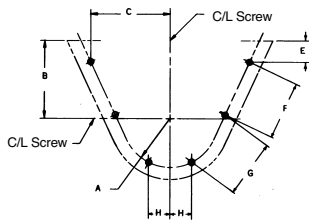

6 Bolts

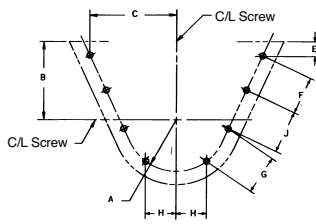

8 Bolts

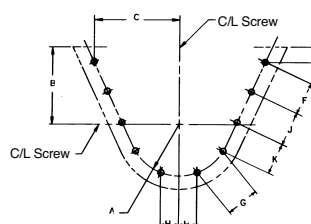

10 Bolts

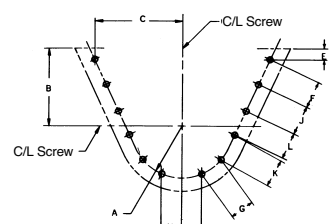

12 Bolts

Screw Diameter Inches	Bolts		A	B	C	E	F	G	H	J	K	L
	Diameter Number	Holes										
6	$\frac{3}{8}$	6	$4\frac{1}{16}$	7	$7\frac{3}{16}$	$1\frac{27}{32}$	$5\frac{1}{4}$	$5\frac{1}{4}$	$2\frac{1}{32}$	—	—	—
9	$\frac{3}{8}$	8	$6\frac{1}{4}$	9	$9\frac{1}{32}$	$1\frac{49}{64}$	5	5	$2\frac{1}{16}$	5	—	—
12	$\frac{1}{2}$	8	$7\frac{15}{16}$	10	$11\frac{13}{16}$	$1\frac{9}{16}$	$5\frac{1}{4}$	$5\frac{1}{4}$	$3\frac{3}{8}$	$5\frac{1}{4}$	—	—
14	$\frac{1}{2}$	10	$8\frac{15}{16}$	11	$12\frac{49}{64}$	$2\frac{1}{16}$	$5\frac{1}{8}$	$5\frac{1}{8}$	3	$5\frac{3}{8}$	$5\frac{1}{8}$	—
16	$\frac{5}{8}$	10	10	$11\frac{1}{2}$	$14\frac{1}{16}$	$2\frac{15}{64}$	$5\frac{1}{2}$	$5\frac{1}{2}$	$3\frac{3}{4}$	$5\frac{1}{2}$	$5\frac{1}{2}$	—
18	$\frac{5}{8}$	10	11	$12\frac{1}{4}$	16	$2\frac{3}{8}$	$6\frac{1}{16}$	$6\frac{1}{16}$	$2\frac{1}{16}$	$6\frac{1}{16}$	$6\frac{1}{16}$	—
20	$\frac{5}{8}$	10	$12\frac{3}{16}$	$13\frac{1}{2}$	$17\frac{1}{8}$	$2\frac{3}{32}$	7	7	$3\frac{1}{32}$	7	7	—
24	$\frac{5}{8}$	12	$14\frac{1}{4}$	$16\frac{1}{2}$	$20\frac{61}{64}$	$2\frac{1}{16}$	$6\frac{3}{8}$	$6\frac{3}{8}$	$3\frac{1}{16}$	$6\frac{3}{8}$	$6\frac{3}{8}$	$6\frac{3}{8}$

CONVEYORS



# Bolt Patterns

## Tubular Housing Flanges

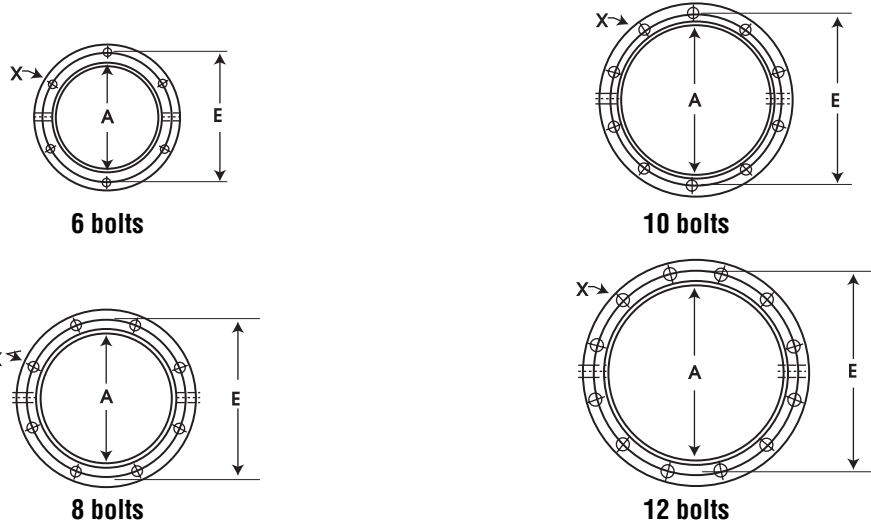

## Intake & Discharge Flanges

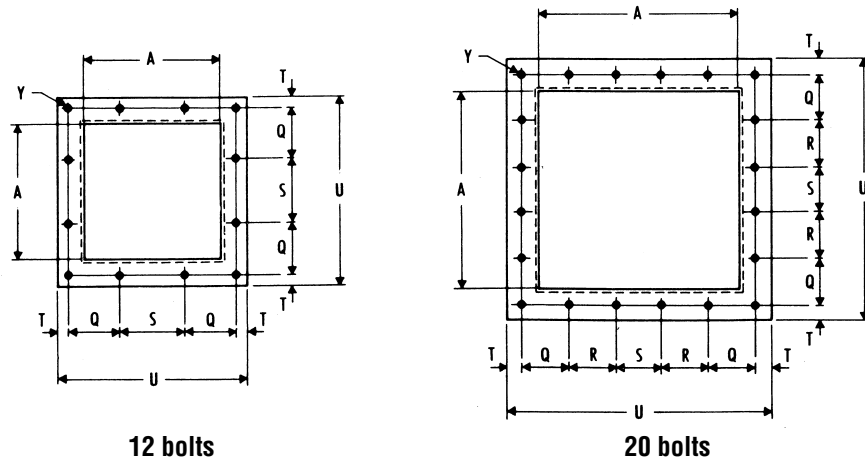

Screw Size	Flange Bolts		A	E	Q	R	S	T	U
	Tubular X	Discharge Y							
4	6-- <sup>3</sup> / <sub>8</sub>	12-- <sup>1</sup> / <sub>4</sub>	5	7	2 <sup>1</sup> / <sub>4</sub>	—	2 <sup>1</sup> / <sub>4</sub>	<sup>3</sup> / <sub>8</sub>	7 <sup>1</sup> / <sub>2</sub>
6	8-- <sup>3</sup> / <sub>8</sub>	12-- <sup>3</sup> / <sub>8</sub>	7	8 <sup>3</sup> / <sub>8</sub>	2 <sup>15</sup> / <sub>16</sub>	—	3	<sup>11</sup> / <sub>16</sub>	10
9	8-- <sup>3</sup> / <sub>8</sub>	12-- <sup>3</sup> / <sub>8</sub>	10	11 <sup>7</sup> / <sub>8</sub>	4	—	4	<sup>1</sup> / <sub>2</sub>	13
10	8-- <sup>3</sup> / <sub>8</sub>	12-- <sup>3</sup> / <sub>8</sub>	11	13 <sup>1</sup> / <sub>4</sub>	4 <sup>5</sup> / <sub>16</sub>	—	4 <sup>3</sup> / <sub>8</sub>	<sup>5</sup> / <sub>8</sub>	14 <sup>1</sup> / <sub>4</sub>
12	8-- <sup>1</sup> / <sub>2</sub>	12-- <sup>3</sup> / <sub>8</sub>	13	15	5 <sup>5</sup> / <sub>8</sub>	—	5 <sup>1</sup> / <sub>4</sub>	<sup>7</sup> / <sub>8</sub>	17 <sup>1</sup> / <sub>4</sub>
14	8-- <sup>1</sup> / <sub>2</sub>	20-- <sup>3</sup> / <sub>8</sub>	15	17	3 <sup>1</sup> / <sub>2</sub>	3 <sup>1</sup> / <sub>2</sub>	3 <sup>1</sup> / <sub>2</sub>	<sup>7</sup> / <sub>8</sub>	19 <sup>1</sup> / <sub>4</sub>
16	8-- <sup>5</sup> / <sub>8</sub>	20-- <sup>3</sup> / <sub>8</sub>	17	19 <sup>1</sup> / <sub>2</sub>	3 <sup>3</sup> / <sub>4</sub>	4	4	<sup>7</sup> / <sub>8</sub>	21 <sup>1</sup> / <sub>4</sub>
18	10-- <sup>5</sup> / <sub>8</sub>	20-- <sup>1</sup> / <sub>2</sub>	19	22	4 <sup>7</sup> / <sub>16</sub>	4 <sup>3</sup> / <sub>8</sub>	4 <sup>3</sup> / <sub>8</sub>	1 <sup>1</sup> / <sub>8</sub>	24 <sup>1</sup> / <sub>4</sub>
20	10-- <sup>5</sup> / <sub>8</sub>	20-- <sup>1</sup> / <sub>2</sub>	21	24 <sup>3</sup> / <sub>8</sub>	4 <sup>7</sup> / <sub>8</sub>	4 <sup>3</sup> / <sub>4</sub>	4 <sup>3</sup> / <sub>4</sub>	1 <sup>1</sup> / <sub>8</sub>	26 <sup>1</sup> / <sub>4</sub>
24	12-- <sup>5</sup> / <sub>8</sub>	20-- <sup>1</sup> / <sub>2</sub>	25	28 <sup>1</sup> / <sub>2</sub>	5 <sup>5</sup> / <sub>8</sub>	5 <sup>5</sup> / <sub>8</sub>	5 <sup>1</sup> / <sub>2</sub>	1 <sup>1</sup> / <sub>8</sub>	30 <sup>1</sup> / <sub>4</sub>

CONVEYORS

# Bolt Requirements



CONVEYORS

Part Name	Bolt Requirements Related to Conveyor Trough Sizes										
	4	6	9	10	12	14	16	18	20	24	
Flange, Trough	6- <sup>3</sup> / <sub>4</sub> x 1	6- <sup>3</sup> / <sub>4</sub> x 1	8- <sup>3</sup> / <sub>4</sub> x 1	8- <sup>3</sup> / <sub>4</sub> x 1	8- <sup>1</sup> / <sub>2</sub> x 1 1/4	8- <sup>1</sup> / <sub>2</sub> x 1 1/4	8- <sup>3</sup> / <sub>4</sub> x 1 1/2	10- <sup>3</sup> / <sub>4</sub> x 1 1/2	10- <sup>3</sup> / <sub>4</sub> x 1 1/2	12- <sup>3</sup> / <sub>4</sub> x 1 1/2	
Flange, Tubular Housing	6- <sup>3</sup> / <sub>4</sub> x 1	8- <sup>3</sup> / <sub>4</sub> x 1	8- <sup>3</sup> / <sub>4</sub> x 1	8- <sup>3</sup> / <sub>4</sub> x 1	8- <sup>1</sup> / <sub>2</sub> x 1 1/4	8- <sup>1</sup> / <sub>2</sub> x 1 1/4	8- <sup>3</sup> / <sub>4</sub> x 1 1/2	10- <sup>3</sup> / <sub>4</sub> x 1 1/2	10- <sup>3</sup> / <sub>4</sub> x 1 1/2	12- <sup>3</sup> / <sub>4</sub> x 1 1/2	
Ends, Trough											
Inside	6- <sup>1</sup> / <sub>4</sub> x 3/4	6- <sup>5</sup> / <sub>16</sub> x 3/4	8- <sup>3</sup> / <sub>4</sub> x 1	8- <sup>3</sup> / <sub>4</sub> x 1	8- <sup>1</sup> / <sub>2</sub> x 1	8- <sup>1</sup> / <sub>2</sub> x 1 1/4	8- <sup>3</sup> / <sub>4</sub> x 1 1/4	10- <sup>3</sup> / <sub>4</sub> x 1 1/4	10- <sup>3</sup> / <sub>4</sub> x 1 1/4	12- <sup>3</sup> / <sub>4</sub> x 1 1/2	
Inside Discharge	2- <sup>1</sup> / <sub>4</sub> x 3/4	2- <sup>5</sup> / <sub>16</sub> x 3/4	4- <sup>3</sup> / <sub>4</sub> x 1	4- <sup>3</sup> / <sub>4</sub> x 1	4- <sup>1</sup> / <sub>2</sub> x 1	4- <sup>1</sup> / <sub>2</sub> x 1 1/4	4- <sup>3</sup> / <sub>4</sub> x 1 1/4	4- <sup>3</sup> / <sub>4</sub> x 1 1/4	4- <sup>3</sup> / <sub>4</sub> x 1 1/4	6- <sup>5</sup> / <sub>16</sub> x 1 1/2	
Inside Rectangular	5- <sup>1</sup> / <sub>4</sub> x 3/4	6- <sup>5</sup> / <sub>16</sub> x 3/4	8- <sup>3</sup> / <sub>4</sub> x 1	8- <sup>3</sup> / <sub>4</sub> x 1	10- <sup>1</sup> / <sub>2</sub> x 1	11- <sup>1</sup> / <sub>2</sub> x 1 1/4	12- <sup>3</sup> / <sub>4</sub> x 1 1/4	12- <sup>3</sup> / <sub>4</sub> x 1 1/4	12- <sup>3</sup> / <sub>4</sub> x 1 1/4	12- <sup>3</sup> / <sub>4</sub> x 1 1/2	
Outside Type	6- <sup>3</sup> / <sub>4</sub> x 1	6- <sup>3</sup> / <sub>4</sub> x 1	8- <sup>3</sup> / <sub>4</sub> x 1	8- <sup>3</sup> / <sub>4</sub> x 1	8- <sup>1</sup> / <sub>2</sub> x 1 1/4	8- <sup>1</sup> / <sub>2</sub> x 1 1/4	8- <sup>3</sup> / <sub>4</sub> x 1 1/4	10- <sup>3</sup> / <sub>4</sub> x 1 1/4	10- <sup>3</sup> / <sub>4</sub> x 1 1/4	12- <sup>3</sup> / <sub>4</sub> x 1 1/2	
Outside Discharge	2- <sup>3</sup> / <sub>4</sub> x 1	2- <sup>3</sup> / <sub>4</sub> x 1	4- <sup>3</sup> / <sub>4</sub> x 1	4- <sup>3</sup> / <sub>4</sub> x 1	4- <sup>1</sup> / <sub>2</sub> x 1 1/4	4- <sup>1</sup> / <sub>2</sub> x 1 1/4	4- <sup>3</sup> / <sub>4</sub> x 1 1/4	4- <sup>3</sup> / <sub>4</sub> x 1 1/4	4- <sup>3</sup> / <sub>4</sub> x 1 1/4	6- <sup>5</sup> / <sub>16</sub> x 1 1/2	
Ends, Tubular Housing	6- <sup>3</sup> / <sub>4</sub> x 1	8- <sup>3</sup> / <sub>4</sub> x 1	8- <sup>3</sup> / <sub>4</sub> x 1	8- <sup>3</sup> / <sub>4</sub> x 1	8- <sup>1</sup> / <sub>2</sub> x 1 1/4	8- <sup>1</sup> / <sub>2</sub> x 1 1/4	8- <sup>3</sup> / <sub>4</sub> x 1 1/4	10- <sup>3</sup> / <sub>4</sub> x 1 1/4	10- <sup>3</sup> / <sub>4</sub> x 1 1/4	12- <sup>3</sup> / <sub>4</sub> x 1 1/2	
Hanger, Trough											
Style 60		2- <sup>1</sup> / <sub>2</sub> x 2	2- <sup>1</sup> / <sub>2</sub> x 2	2- <sup>1</sup> / <sub>2</sub> x 2	2- <sup>1</sup> / <sub>2</sub> x 2 1/2	2- <sup>1</sup> / <sub>2</sub> x 2 1/2	2- <sup>3</sup> / <sub>4</sub> x 2 1/4	2- <sup>3</sup> / <sub>4</sub> x 2 1/4	2- <sup>3</sup> / <sub>4</sub> x 2 1/4	2- <sup>3</sup> / <sub>4</sub> x 2 1/4	
Style 70		4- <sup>3</sup> / <sub>4</sub> x 1	4- <sup>3</sup> / <sub>4</sub> x 1 1/4	4- <sup>3</sup> / <sub>4</sub> x 1 1/4	4- <sup>1</sup> / <sub>2</sub> x 1 1/2	4- <sup>1</sup> / <sub>2</sub> x 1 1/2	4- <sup>1</sup> / <sub>2</sub> x 1 1/2	4- <sup>1</sup> / <sub>2</sub> x 1 1/2	4- <sup>1</sup> / <sub>2</sub> x 1 1/2	4- <sup>1</sup> / <sub>2</sub> x 1 1/2	
Style 216		4- <sup>3</sup> / <sub>4</sub> x 1 1/4	4- <sup>3</sup> / <sub>4</sub> x 1 1/4	4- <sup>3</sup> / <sub>4</sub> x 1 1/4	4- <sup>1</sup> / <sub>2</sub> x 1 1/2	4- <sup>1</sup> / <sub>2</sub> x 1 1/2	4- <sup>1</sup> / <sub>2</sub> x 1 1/2	4- <sup>1</sup> / <sub>2</sub> x 1 1/2	4- <sup>1</sup> / <sub>2</sub> x 1 1/2	4- <sup>1</sup> / <sub>2</sub> x 1 1/2	
Style 220	4- <sup>1</sup> / <sub>4</sub> x 1	4- <sup>3</sup> / <sub>4</sub> x 1	4- <sup>3</sup> / <sub>4</sub> x 1	4- <sup>3</sup> / <sub>4</sub> x 1	4- <sup>1</sup> / <sub>2</sub> x 1 1/4	4- <sup>1</sup> / <sub>2</sub> x 1 1/4	4- <sup>1</sup> / <sub>2</sub> x 1 1/4	4- <sup>1</sup> / <sub>2</sub> x 1 1/4	4- <sup>1</sup> / <sub>2</sub> x 1 1/4	4- <sup>1</sup> / <sub>2</sub> x 1 1/4	
Style 226	4- <sup>1</sup> / <sub>4</sub> x 1	4- <sup>3</sup> / <sub>4</sub> x 1 1/4	4- <sup>3</sup> / <sub>4</sub> x 1 1/4	4- <sup>3</sup> / <sub>4</sub> x 1 1/4	4- <sup>1</sup> / <sub>2</sub> x 1 1/2	4- <sup>1</sup> / <sub>2</sub> x 1 1/2	4- <sup>1</sup> / <sub>2</sub> x 1 1/2	4- <sup>1</sup> / <sub>2</sub> x 1 1/2	4- <sup>1</sup> / <sub>2</sub> x 1 1/2	4- <sup>1</sup> / <sub>2</sub> x 1 1/2	
Style 230	4- <sup>1</sup> / <sub>4</sub> x 1	4- <sup>3</sup> / <sub>4</sub> x 1	4- <sup>3</sup> / <sub>4</sub> x 1	4- <sup>3</sup> / <sub>4</sub> x 1	4- <sup>1</sup> / <sub>2</sub> x 1 1/4	4- <sup>1</sup> / <sub>2</sub> x 1 1/4	4- <sup>1</sup> / <sub>2</sub> x 1 1/4	4- <sup>1</sup> / <sub>2</sub> x 1 1/4	4- <sup>1</sup> / <sub>2</sub> x 1 1/4	4- <sup>1</sup> / <sub>2</sub> x 1 1/4	
Style 316	4- <sup>1</sup> / <sub>4</sub> x 1	4- <sup>3</sup> / <sub>4</sub> x 1	4- <sup>3</sup> / <sub>4</sub> x 1	4- <sup>3</sup> / <sub>4</sub> x 1	4- <sup>1</sup> / <sub>2</sub> x 1 1/4	4- <sup>1</sup> / <sub>2</sub> x 1 1/4	4- <sup>1</sup> / <sub>2</sub> x 1 1/4	4- <sup>1</sup> / <sub>2</sub> x 1 1/4	4- <sup>1</sup> / <sub>2</sub> x 1 1/4	4- <sup>1</sup> / <sub>2</sub> x 1 1/4	
Style 326	4- <sup>1</sup> / <sub>4</sub> x 1	4- <sup>3</sup> / <sub>4</sub> x 1	4- <sup>3</sup> / <sub>4</sub> x 1	4- <sup>3</sup> / <sub>4</sub> x 1	4- <sup>1</sup> / <sub>2</sub> x 1 1/4	4- <sup>1</sup> / <sub>2</sub> x 1 1/4	4- <sup>1</sup> / <sub>2</sub> x 1 1/4	4- <sup>1</sup> / <sub>2</sub> x 1 1/4	4- <sup>1</sup> / <sub>2</sub> x 1 1/4	4- <sup>1</sup> / <sub>2</sub> x 1 1/4	
Covers, Trough (Std. 10 ft.)	10- <sup>5</sup> / <sub>16</sub> x 3/4	10- <sup>5</sup> / <sub>16</sub> x 3/4	10- <sup>5</sup> / <sub>16</sub> x 3/4	10- <sup>5</sup> / <sub>16</sub> x 3/4	10- <sup>5</sup> / <sub>16</sub> x 3/4	10- <sup>5</sup> / <sub>16</sub> x 3/4	10- <sup>5</sup> / <sub>16</sub> x 3/4	10- <sup>5</sup> / <sub>16</sub> x 3/4	10- <sup>5</sup> / <sub>16</sub> x 3/4	10- <sup>5</sup> / <sub>16</sub> x 3/4	
Saddle — Feet											
Flanged Feet	2- <sup>3</sup> / <sub>4</sub> x 1 1/4	2- <sup>3</sup> / <sub>4</sub> x 1 1/4	2- <sup>3</sup> / <sub>4</sub> x 1 1/4	2- <sup>3</sup> / <sub>4</sub> x 1 1/4	2- <sup>1</sup> / <sub>2</sub> x 1 1/2	2- <sup>1</sup> / <sub>2</sub> x 1 1/2	2- <sup>3</sup> / <sub>4</sub> x 1 3/4	2- <sup>3</sup> / <sub>4</sub> x 1 3/4	2- <sup>3</sup> / <sub>4</sub> x 1 3/4	2- <sup>3</sup> / <sub>4</sub> x 1 3/4	
Saddle	2- <sup>1</sup> / <sub>4</sub> x 1	2- <sup>1</sup> / <sub>4</sub> x 1	2- <sup>3</sup> / <sub>4</sub> x 1	2- <sup>3</sup> / <sub>4</sub> x 1	2- <sup>1</sup> / <sub>2</sub> x 1 1/4	2- <sup>1</sup> / <sub>2</sub> x 1 1/4	2- <sup>3</sup> / <sub>4</sub> x 1 1/4	2- <sup>3</sup> / <sub>4</sub> x 1 1/4	2- <sup>3</sup> / <sub>4</sub> x 1 1/4	2- <sup>3</sup> / <sub>4</sub> x 1 1/4	
Spouts, Discharge											
Attaching Bolts	8- <sup>3</sup> / <sub>4</sub> x 1 1/2	8- <sup>3</sup> / <sub>4</sub> x 1 1/2	8- <sup>3</sup> / <sub>4</sub> x 1 1/2	8- <sup>3</sup> / <sub>4</sub> x 1 1/2	8- <sup>3</sup> / <sub>4</sub> x 1 1/2	12- <sup>3</sup> / <sub>4</sub> x 1 1/2	12- <sup>3</sup> / <sub>4</sub> x 1 1/2	12- <sup>3</sup> / <sub>4</sub> x 1 1/2	12- <sup>3</sup> / <sub>4</sub> x 1 1/2	12- <sup>3</sup> / <sub>4</sub> x 1 1/2	
Flange	12- <sup>3</sup> / <sub>4</sub> x 1	12- <sup>3</sup> / <sub>4</sub> x 1	12- <sup>3</sup> / <sub>4</sub> x 1	12- <sup>3</sup> / <sub>4</sub> x 1	12- <sup>3</sup> / <sub>4</sub> x 1	20- <sup>3</sup> / <sub>4</sub> x 1	20- <sup>3</sup> / <sub>4</sub> x 1	20- <sup>3</sup> / <sub>4</sub> x 1	20- <sup>3</sup> / <sub>4</sub> x 1	20- <sup>3</sup> / <sub>4</sub> x 1	
Flange w/Slide	10- <sup>3</sup> / <sub>4</sub> x 1	10- <sup>3</sup> / <sub>4</sub> x 1	10- <sup>3</sup> / <sub>4</sub> x 1	10- <sup>3</sup> / <sub>4</sub> x 1	10- <sup>3</sup> / <sub>4</sub> x 1	16- <sup>3</sup> / <sub>4</sub> x 1	16- <sup>3</sup> / <sub>4</sub> x 1	16- <sup>3</sup> / <sub>4</sub> x 1	16- <sup>3</sup> / <sub>4</sub> x 1	16- <sup>3</sup> / <sub>4</sub> x 1	

All bolts hex head cap screws with hex nuts and lock washers.



# Bolt Requirements

Part Name	Bolt Requirements Related to Shaft Coupling Sizes					
	1	1½	2	2½	3	3½
Bearings, End						
Discharge Bronze	3-3/8 x 1¼	3-½ x 1½	3-5/8 x 1¾	3-5/8 x 1¾	3-3/4 x 2	3-3/4 x 2¼
Discharge Ball	3-3/8 x 1¼	3-½ x 1½	3-5/8 x 1¾	3-5/8 x 1¾	3-3/4 x 2	3-3/4 x 2¼
Flanged Bronze	4-3/8 x 1¼	4-½ x 1½	4-5/8 x 1¾	4-5/8 x 1¾	4-3/4 x 2	4-3/4 x 2¼
Flanged Ball	4-3/8 x 1¼	4-½ x 1½	4-5/8 x 1¾	4-5/8 x 1¾	4-3/4 x 2	4-3/4 x 2¼
Flanged Roller		4-½ x 2	4-½ x 2¼	4-5/8 x 2½	4-3/4 x 2¾	4-3/4 x 3¼
Pillow Block Bronze	2-3/8 x 1½	2-½ x 1¾	2-5/8 x 2	2-5/8 x 2¼	2-3/4 x 2½	2-7/8 x 2¾
Pillow Block Ball	2-3/8 x 1¾	2-½ x 2¼	2-5/8 x 2½	2-5/8 x 2½	2-7/8 x 3½	2-7/8 x 3¾
Pillow Block, Roller		2-½ x 2¼	2-5/8 x 2½	2-5/8 x 2½	2-3/4 x 3	2-7/8 x 3½
Bearings, Thrust						
Type "E" Roller		4-½ x 2¾	4-½ x 2¾	4-5/8 x 3¼	4-3/4 x 3½	4-3/4 x 3¾
Coupling Bolts	3/8 x 2/16	½ x 3	5/8 x 3¾	5/8 x 4¾	¾ x 5-3/8" Pipe ¾ x 5-1/2-4" Pipe	7/8 x 5½
Seals, Shafts						
Flanged Gland		4-½ x 1½	4-5/8 x 1½	4-5/8 x 1½	4-3/4 x 1¾	4-3/4 x 1¾
Plate w/Ball or Bronze		4-½ x 2	4-5/8 x 2¼	4-5/8 x 2¼	4-3/4 x 2¾	4-3/4 x 3
Plate w/Roller		4-½ x 2½	4-½ x 2¾	4-5/8 x 3	4-3/4 x 3¼	4-3/4 x 3½
Split Gland		2-½ x 1½	2-½ x 1½	2-5/8 x 1¾	2-5/8 x 1¾	2-3/4 x 2¼
Waste Pack, w/Ball or Bronze		4-½ x 3¼	4-5/8 x 3½	4-5/8 x 3¾	4-3/4 x 4	4-3/4 x 4¾
Waste Pack, w/Roller		4-½ x 3¾	4-½ x 4	4-5/8 x 4	4-3/4 x 4¼	4-3/4 x 4½

\*See page H-87 for special coupling bolts.  
All other bolts hex head cap screws with hex nuts and lock washers.

CONVEYORS

# Pipe Sizes, Dimensions and Weights



Nominal Pipe Size Inches	Outside Diameter Inches	I.P.S. Schedule	Wall Inches	Inside Diameter Inches	Wt./Ft. Pounds	Nominal Pipe Size Inches	Outside Diameter Inches	I.P.S. Schedule	Wall Inches	Inside Diameter Inches	Wt./Ft. Pounds
⅛	.405	10S	.049	.307	.1863	3	3.500	5S	.083	3.334	3.029
		40 40S Est.	.068	.269	.2447			10S	.120	3.260	4.332
		80 80S Ex. Hvy.	.095	.215	.3145			40 40S Est.	.216	3.068	7.576
¼	.540	10S	.065	.410	.3297	3½	4.000	80 80S Ex. Hvy.	.300	2.900	10.25
		40 40S Est.	.088	.364	.4248			160	.438	2.624	14.32
		80 80S Ex. Hvy.	.119	.302	.5351			XX Hvy.	.600	2.300	18.58
⅜	.675	10S	.065	.545	.4235	4	4.500	5S	.083	3.834	3.472
		40 40S Std.	.091	.493	.5676			10S	.120	3.760	4.973
		80 80S Ex. Hvy.	.126	.423	.7388			40 40S Std.	.226	3.548	9.109
½	.840	10S	.065	.710	.5383	5	5.563	80 80S Ex. Hvy.	.318	3.364	12.50
		40 40S Est.	.109	.622	.8510			5S	.109	5.345	6.349
		80 80S Ex. Hvy.	.147	.546	1.088			10S	.134	5.295	7.770
¾	1.050	160	.187	.466	1.304	6	6.625	40 40S Est.	.237	4.026	10.79
		XX Hvy.	.294	.252	1.714			80 80S Ex. Hvy.	.337	3.826	14.98
		5S	.065	.920	.6838			120	.438	3.624	19.00
1	1.315	10S	.083	.884	.8572	8	8.625	160	.531	3.438	22.51
		40 40S Std.	.113	.824	1.131			XX Hvy.	.674	3.152	27.54
		80 80S Ex. Hvy.	.154	.742	1.474			5S	.109	6.407	7.585
1¼	1.660	160	.218	.614	1.937	10	10.750	40 40S Std.	.280	6.065	18.97
		XX Hvy.	.308	.434	2.441			80 80S Ex. Hvy.	.432	5.761	28.57
		5S	.065	1.185	.8678			120	.562	5.491	36.39
1½	1.900	10S	.109	1.049	1.679	10	10.750	160	.718	5.189	45.30
		40 40S Std.	.133	1.049	1.679			XX Hvy.	.864	4.897	53.16
		80 80S Ex. Hvy.	.179	.957	2.172			5S	.109	8.407	9.914
1¾	2.375	160	.250	.815	2.844	10	10.750	10S	.148	8.329	13.40
		XX Hvy.	.358	.599	3.659			40 40S Est.	.322	7.981	28.55
		5S	.065	1.530	1.107			60	.406	7.813	35.64
2	2.875	10S	.109	1.442	1.806	10	10.750	80 80S Ex. Hvy.	.500	7.625	43.39
		40 40S Std.	.140	1.380	2.273			100	.593	7.439	50.87
		80 80S Ex. Hvy.	.191	1.278	2.997			120	.718	7.189	60.63
2½	3.625	160	.250	1.160	3.765	10	10.750	140	.812	7.001	67.76
		XX Hvy.	.382	.896	5.214			160	.906	6.813	74.69
		5S	.065	2.245	1.604			5S	.134	10.482	15.19
3	4.500	10S	.109	2.157	2.638	10	10.750	10S	.165	10.420	18.70
		40 40S Std.	.154	2.067	3.653			20	.250	10.250	28.04
		80 80S Ex. Hvy.	.218	1.939	5.022			30	.307	10.136	34.24
3½	5.563	160	.343	1.689	7.444	10	10.750	40 40S Std.	.365	10.020	40.48
		XX Hvy.	.436	1.503	9.029			60 80S Ex. Hvy.	.500	9.750	54.74
		5S	.065	2.709	2.475			80	.593	9.564	64.33
4	6.625	10S	.109	2.635	3.531	10	10.750	100	.718	9.224	76.93
		40 40S Std.	.145	2.610	4.718			120	.843	9.064	89.20
		80 80S Ex. Hvy.	.200	2.500	6.631			140	1.000	8.750	104.1
4½	7.875	160	.281	1.338	4.859	10	10.750	160	1.125	8.500	115.7
		XX Hvy.	.400	1.100	6.408						
		5S	.065	2.709	2.475						

NOTE:  
Weights shown are in pounds per foot, based on the average wall of the pipe. The following formula was used in calculating the weight per foot.

W = 10.68 (D - t)  
W = Weight in pounds per foot (to 4 digits)  
D = Outside Diameter in inches (to 3 decimal places)  
t = Wall thickness in decimals (to 3 decimal places)

All weights are carried to four digits only, the fifth digit being carried forward if five or over, or dropped if under five.

CONVEYORS



# Typical Drive Arrangements

The most common types of drives for Screw Conveyors are illustrated below.

In addition to those shown, other types available are: variable speed drives, hydraulic drives, and take-off drives for connection to other equipment.

For special drive requirements, consult our Engineering Department.

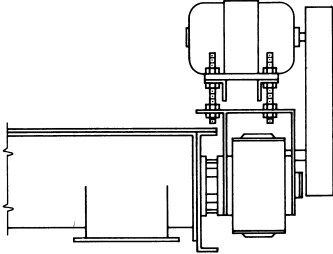
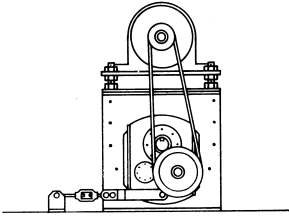
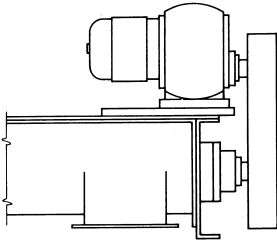
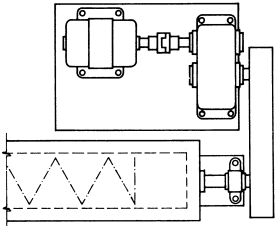
<p>Screw Driver Reducer</p>	 <p>(Side View)</p>	<p>Reducer mounts on trough end, and is directly connected to the conveyor screw and includes integral thrust bearing, seal gland, and drive shaft. Motor mount may be positioned at top, either side, or below. Separate drive shaft, end bearing, and seal are not required.</p>
<p>Shaft Mounted Reducer</p>	 <p>(End View)</p>	<p>Reducer mounts on conveyor drive shaft. Motor and "V"-Belt drive may be in any convenient location. The torque arm may be fastened to the floor, or fitted to trough end. Requires extended drive shaft, end bearing, and seal.</p> <p>Note: Requires thrust unit or collars to hold thrust.</p>
<p>Gearmotor Drive</p>	 <p>(Side View)</p>	<p>Integral motor-reducer with chain drive to conveyor drive shaft. Usually mounted to top of trough by means of an adapter plate.</p>
<p>Base Type Reducer Drive</p>	 <p>(Top View)</p>	<p>Motor direct-coupled to base type reducer, with chain drive to conveyor drive shaft. Usually mounted on floor or platform as close as possible to conveyor.</p>

CONVEYORS

# CEMA Standards



## Helicoid Screw Conveyors

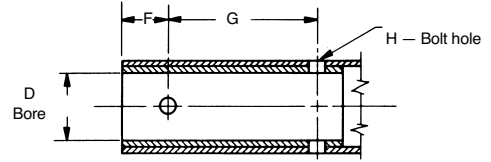
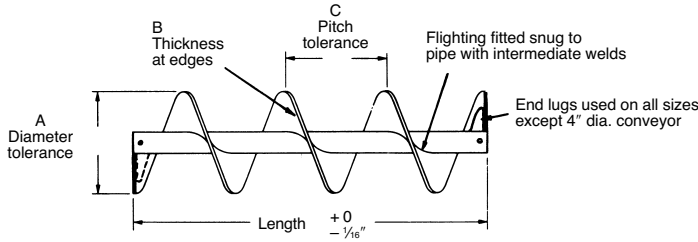

Listed Screw Diameter and Pitch	Coupling Diameter	Size Designation	Pipe Size Schedule 40	Length Feet and Inches	A		B		C		D		F	G	H
					Diameter Tolerance		Thickness		Pitch Tolerance		Bushing Bore Inside Diameter		Spacing 1st Bolt Hole	Centers 2nd Bolt Hole	Nominal Bolt Hole Size
					Plus	Minus	Inner Edge	Outer Edge	Plus	Minus	Minimum	Maximum			
4	1	4H206	1 1/4	9-10 1/2	1/16	3/16	3/16	3/32	1/2	1/4	1.005	1.016	1/2	2	17/32
6	1 1/2	6H304	2	9-10	1/16	3/16	1/4	1/16	1/2	1/4	1.505	1.516	7/8	3	17/32
6	1 1/2	6H308	2	9-10	1/16	3/16	3/8	3/16	3/4	1/4	1.505	1.516	7/8	3	17/32
6	1 1/2	6H312	2	9-10	1/16	3/16	3/8	3/16	3/4	1/4	1.505	1.516	7/8	3	17/32
9	1 1/2	9H306	2	9-10	1/16	3/16	3/16	3/32	3/4	1/4	1.505	1.516	7/8	3	17/32
9	1 1/2	9H312	2	9-10	1/16	3/16	3/8	3/16	3/4	1/4	1.505	1.516	7/8	3	17/32
9	2	9H406	2 1/2	9-10	1/16	3/16	3/16	3/32	3/4	1/4	2.005	2.016	7/8	3	21/32
9	2	9H412	2 1/2	9-10	1/16	1/4	3/8	3/16	3/4	1/4	2.005	2.016	7/8	3	21/32
9	2	9H414	2 1/2	9-10	1/16	1/4	7/16	7/32	3/4	1/4	2.005	2.016	7/8	3	21/32
10	1 1/2	10H306	2	9-10	1/16	3/16	3/16	3/32	3/4	1/4	1.505	1.516	7/8	3	17/32
10	2	10H412	2 1/2	9-10	1/16	1/4	3/8	3/16	3/4	1/4	2.005	2.016	7/8	3	21/32
12	2	12H408	2 1/2	11-10	1/8	5/16	1/4	1/8	1	1/4	2.005	2.016	7/8	3	21/32
12	2	12H412	2 1/2	11-10	1/8	3/16	3/8	3/16	1	1/4	2.005	2.016	7/8	3	21/32
12	2 1/16	12H508	3	11-9	1/8	3/16	1/4	1/8	1	1/4	2.443	2.458	15/16	3	21/32
12	2 1/16	12H512	3	11-9	1/8	5/16	3/8	3/16	1	1/4	2.443	2.458	15/16	3	21/32
12	3	12H614	3 1/2	11-9	1/8	3/8	7/16	7/32	1	1/4	3.005	3.025	1	3	25/32
14	2 1/16	14H508	3	11-9	1/8	5/16	1/4	1/8	1	1/4	2.443	2.458	15/16	3	21/32
14	3	14H614	3 1/2	11-9	1/8	3/8	7/16	7/32	1	1/4	3.005	3.025	1	3	25/32
16	3	16H610	3 1/2	11-9	1/8	3/8	5/16	3/32	1 1/2	1/4	3.005	3.025	1	3	25/32
16	3	16H614	4	11-9	1/8	3/8	7/16	7/32	1 1/2	1/4	3.005	3.025	1	3	25/32

NOTE: All dimensions in inches.

## Cut Flight/Cut & Folded Flight Conveyors

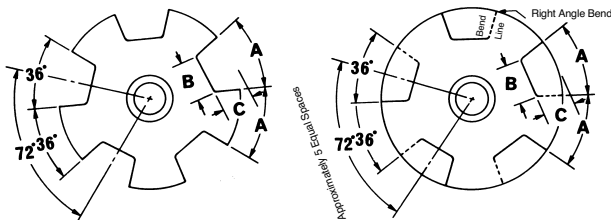

Depth of cut "C" is one half the flight width for normal maximum pipe size. Lengths "A" and "B" are calculated from the developed O.D. for standard pitch.

Screw Diameter	A	B	C
4	1 3/8	1	5/8
6	2	1 1/2	7/8
9	3	2 1/2	1 1/2
10	3 3/8	2 1/4	1 3/4
12	4	2 3/4	2
14	4 5/8	3 1/8	2 1/2
16	5 1/4	3 1/2	3
18	6	3 3/8	3 3/8
20	6 3/4	4 1/4	3 3/4
24	7 3/4	4 3/4	4 1/4

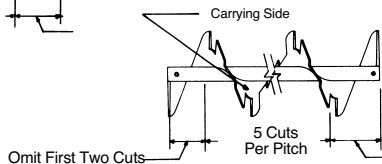
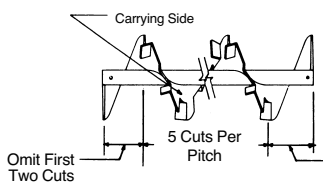





**CEMA  
Standards**

**Sectional Screw Conveyors**

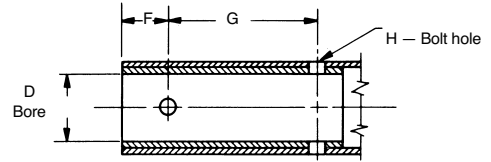
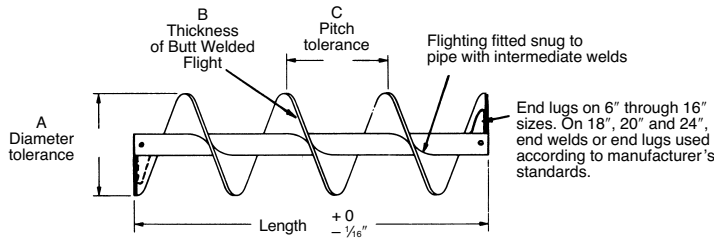

Listed Screw Diameter and Pitch	Cplng. Dia.	Size Designation	Pipe Size Schedule 40	Length Feet and Inches	A		B	C		D		F	G	H
					Diameter Tolerance			Pitch Tolerance	Bushing Bore Inside Diameter					
					Plus	Minus	Plus		Minus	Minimum	Maximum			
6	1½	6S312	2	9-10	¼	¾	¾	¾	¼	1.505	1.516	¾	3	17/32
	1½	9S312	2	9-10	¼	¾	¾	½	¼	1.505	1.516	¾	3	17/32
9	2	9S412	2½	9-10	¼	¾	¾	½	¼	2.005	2.016	¾	3	21/32
	2	9S416	2½	9-10	¼	¼	¼	½	¼	2.005	2.016	¾	3	21/32
10	2	10S412	2½	9-10	¼	¾	¾	½	¼	2.005	2.016	¾	3	21/32
12	2	12S412	2½	11-10	½	5/16	¾	¾	¼	2.005	2.016	¾	3	21/32
	2½	12S512	3	11-9	½	5/16	¾	¾	¼	2.443	2.458	15/16	3	21/32
	2½	12S516	3	11-9	½	5/16	¼	¾	¼	2.443	2.458	15/16	3	21/32
	3	12S616	3½	11-9	½	5/16	¼	¾	¼	3.005	3.025	1	3	25/32
14	3	12S624	3½	11-9	½	¾	¾	¾	¼	3.005	3.025	1	3	25/32
	2½	14S512	3	11-9	½	5/16	¾	¾	¼	2.443	2.458	15/16	3	21/32
	3	14S616	3½	11-9	½	5/16	¼	¾	¼	3.005	3.025	1	3	25/32
16	3	14S624	3½	11-9	½	¾	¾	¾	¼	3.005	3.025	1	3	25/32
	3	16S612	3½	11-9	½	¾	¾	¾	¼	3.005	3.025	1	3	25/32
	3	16S616	3½	11-9	½	¾	¼	¾	¼	3.005	3.025	1	3	25/32
	3	16S624	3½	11-9	½	¾	¾	¾	¼	3.005	3.025	1	3	25/32
18	3	16S632	3½	11-9	½	½	½	¾	¼	3.005	3.025	1	3	25/32
	3	18S612	3½	11-9	¾	¾	¾	¾	½	3.005	3.025	1	3	25/32
	3	18S616	3½	11-9	¾	¾	¼	¾	½	3.005	3.025	1	3	25/32
	3	18S624	3½	11-9	¾	¾	¾	¾	½	3.005	3.025	1	3	25/32
20	3	18S632	3½	11-9	¾	½	½	¾	½	3.005	3.025	1	3	25/32
	3	20S612	3½	11-9	¾	¾	¾	¾	½	3.005	3.025	1	3	25/32
	3	20S616	3½	11-9	¾	¾	¼	¾	½	3.005	3.025	1	3	25/32
	3	20S624	3½	11-9	¾	¾	¾	¾	½	3.005	3.025	1	3	25/32
24	3½	24S712	4	11-8	¾	¾	¾	¾	½	3.443	3.467	1½	4	29/32
	3½	24S716	4	11-8	¾	¾	¼	¾	½	3.443	3.467	1½	4	29/32
	3½	24S724	4	11-8	¾	¾	¾	¾	½	3.443	3.467	1½	4	29/32
	3½	24S732	4	11-8	¾	½	½	¾	½	3.443	3.467	1½	4	29/32

NOTE: All dimensions in inches.

CONVEYORS

# Sample Work Sheet



Client: \_\_\_\_\_ Date Quote Due: \_\_\_\_\_

Conveyor No.: \_\_\_\_\_ Inquiry No.: \_\_\_\_\_

Table 1-2

\_\_\_\_\_ Dia. x Length **L** = \_\_\_\_\_ Recommended % Trough Loading: \_\_\_\_\_

Material: \_\_\_\_\_ Material HP Factor: **FM** = \_\_\_\_\_

Capacity: \_\_\_\_\_ Component Series: \_\_\_\_\_

Density: **W** = \_\_\_\_\_ Lbs/Ft<sup>3</sup> Intermediate Hanger Bearing Series: \_\_\_\_\_

Lumps: Max. Size \_\_\_\_\_ in. Class (I) (II) (III) \_\_\_\_\_ Notes: \_\_\_\_\_

Required Capacity = **C** = \_\_\_\_\_ CFH (cubic feet per hour)

$$CFH = \frac{TPH \times 2000}{W}$$

$$CFH = \frac{Pounds \text{ per Hour}}{W}$$

CFH = Bushels per Hour x 1.24

Tables 1-3, 1-4, 1-5

Equivalent Capacity =  $\frac{Req'd \text{ Capacity}}{CF_1} \times CF_2 \times CF_3 =$  \_\_\_\_\_ CFH

Equivalent Capacity

Table 1-6

Screw Diameter = \_\_\_\_\_ Select Diameter from 'at max RPM' column where capacity listed equals or exceeds equivalent capacity

Screw RPM = **N** = \_\_\_\_\_ =  $\frac{Equivalent \text{ Capacity}}{Capacity \text{ 'at one RPM' for diameter selected}}$

Table 1-7

Check lump size and lump class for diameter selected. If larger screw diameter recommended, recalculate RPM per instructions above for selected diameter.

Tables 1-12, 1-13, 1-14, 1-15, 1-16, 1-17

Values to be substituted in formula: **Fd Fb Ff Fp e**

$$HPf = \frac{L}{1,000,000} \left( \frac{N}{1,000,000} \right) \left( \frac{Fd}{1,000,000} \right) \left( \frac{Fb}{1,000,000} \right) =$$

**NOTE:** Consult factory for feeder horsepower

$$HPm = \frac{C}{1,000,000} \left( \frac{L}{1,000,000} \right) \left( \frac{W}{1,000,000} \right) \left( \frac{Ff}{1,000,000} \right) \left( \frac{Fm}{1,000,000} \right) \left( \frac{Fp}{1,000,000} \right) =$$

If HPf + HPm is less than 5.2, select overload factor **F<sub>O</sub>** = \_\_\_\_\_ (If HPf + HPm is greater than 5.2, **F<sub>O</sub>** = 1.0)

Total HP =  $\frac{(HPf + HPm) F_o}{e} =$  \_\_\_\_\_ = \_\_\_\_\_

**DRIVE:** Use \_\_\_\_\_ HP motor with AGMA Class (I) (II) (III) Drive at \_\_\_\_\_ Screw RPM

Tables 1-18, 1-19

Torque =  $\frac{Motor \text{ HP} \times 63,025}{Screw \text{ RPM}} =$  \_\_\_\_\_ in.-lbs.

List Minimum Size: Shaft Dia. \_\_\_\_\_ Pipe \_\_\_\_\_ Bolt/Shear \_\_\_\_\_ Bolt/Bearing \_\_\_\_\_

Tables 1-8, 1-9, 1-10, 1-11

Select Components:  
Trough \_\_\_\_\_ Screw \_\_\_\_\_ Hanger Style \_\_\_\_\_ Hanger Bearing \_\_\_\_\_ Cover \_\_\_\_\_

CONVEYORS



# Components

## SECTION III

COMPONENT SECTION III	PAGE
Component Selection . . . . .	H-52
Trough . . . . .	H-54
Discharges and Gates . . . . .	H-58
Trough Ends . . . . .	H-64
Saddles and Feet/Trough End Flanges . . . . .	H-71
End Bearings . . . . .	H-72
Thrust Bearings . . . . .	H-74
Seals . . . . .	H-76
Conveyor Screws . . . . .	H-79
Coupling Bolts, Internal Collars and Lugs . . . . .	H-87
Shafts . . . . .	H-88
Hangers . . . . .	H-93
Hanger Bearings . . . . .	H-101
Covers . . . . .	H-103
Cover Accessories . . . . .	H-105
Conveyor Shrouds . . . . .	H-106

CONVEYORS

**SEE PRICE LIST FOR ITEMS CARRIED  
IN STOCK**

# Component Selection



## Required Information

Screw diameter  
Shaft diameter  
Material component group  
Unusual material characteristics

## Conveyor Screws

Standard length conveyor screws should be used whenever possible to reduce the number of hanger bearings required.

The recommended screws listed in the Component Series Table are standard helicoid and sectional screw conveyors. The use of helicoid or sectional conveyors is largely a matter of individual preference.

Right hand screw conveyors pull material toward the end which is being rotated in a clockwise direction. If the rotation is reversed (counterclockwise), the material is pushed away from that end.

In left hand screw conveyors, the material flow is opposite to that of right hand screws, the direction of rotation being unchanged.

To determine hand of screw see pages H-38 and H-39.

The material is carried on one face of the conveyor flighting in conveyors which are required to transport material in one direction, therefore, conveyor end lugs are located on the opposite face to facilitate unimpeded flow of the material. Conveyor sections must be installed in such a manner that all end lugs are toward the inlet end of the conveyor. Conveyor sections must not be turned end for end without reversing the direction of rotation, or conversely, the direction of rotation must not be reversed without turning the conveyor sections end for end.

Requirements for reversible conveyor screws intended for material transport in either direction should be referred to our Engineering Department.

Flighting should be omitted from the conveyor pipe over the last discharge opening to ensure complete discharge of material without carryover.

Continuity of material flow at hanger points is accomplished by opposing adjacent flight ends approximately 180°. (As close to 180° as the predrilled holes will allow.)

## Conveyor Trough and Tubular Housing

Standard trough and housing sections are available in five, six, ten, and 12 foot lengths. Standard five and six foot lengths should be used when connecting flanges coincide with discharge openings or hanger bearings.

## Shafts

The primary consideration in determining the type and size of coupling and drive shafts is whether the shafts selected are adequate to transmit the horsepower required, including any overload. Normally, cold-rolled shafts are adequate. However, high-tensile shafts may be required due to torque limitations. Also, stainless steel shafts may be necessary when corrosive or contaminable materials are to be handled. Conveyors equipped with non-lubricated hard iron hanger bearings require hardened coupling shafts. Specific shaft size determination is covered in the Torsional Rating Section, page H-27.

## Shaft Seals

Several conveyor end seal types are available to prevent contamination of the conveyed material or to prevent the escape of material from the system.

## Bearings

**Hanger Bearing** — The purpose of hanger bearings is to provide intermediate support when multiple screw sections are used. Hanger bearings are designed primarily for radial loads. Therefore, adequate clearance should be allowed between the bearings and the conveyor pipe ends to prevent damage by the thrust load which is transmitted through the conveyor pipe.

The hanger bearing recommendations listed in the Material Characteristic Tables are generally adequate for the material to be handled. Often, however, unusual characteristics of the material or the conditions under which the conveyor must operate make it desirable to use special bearing materials. Regarding the use of special bearing materials, consult our Engineering Department.

**End Bearings** — Several end bearing types are available, and their selection depends on two basic factors: Radial load and thrust load. The relative values of these loads determines end bearing types.



## Component Selection

Radial load is negligible at the conveyor tail shaft. However, drive ends (unless integrated with the conveyor end plate) are subject to radial loading due to overhung drive loads, such as chain sprockets or shaft-mounted speed reducers. Screw Conveyor Drive Reducers at the drive end will adequately carry both thrust and radial loads.

### Discharge Spouts and Gates

Standard discharge spouts and gates are available for either conveyor trough or tubular housing in several designs, operated either manually or by remote controls.

In installations where it is possible to overfill the device to which material is being transported, an additional overflow discharge opening or overflow relief device should be provided. Consult our Engineering Department for suggested electrical interlock and safety devices to prevent overflow or damage to equipment.

It is sometimes found that the material characteristics are such that standard component specifications are inadequate. Should unusual material characteristics or severe conditions exist, our Engineering Department should be consulted.

### Conveyor Ends

A complete line of conveyor ends are available as standard for either conveyor trough or tubular housing with a choice of many bearing types and combinations.

### Special Applications

More common of the unusual material characteristics which require other than the recommended components are:

**Corrosive Materials** — Components may be fabricated from alloys not affected by the material or may be coated with a protective substance.

**Contaminable Materials** — Require the use of oil impregnated, sealed, or dry type hanger bearings. End shafts should be sealed to prevent entrance of contaminants from the outside. Due to the necessity for frequent cleaning conveyor components should be designed for convenient disassembly.

**Abrasive Materials** — These materials may be handled in conveyors, troughs, or housings constructed of abrasion resistant alloys with hard surfaced screws. Lining of all exposed surfaces with rubber or special resins also materially reduces abrasive damage.

**Interlocking or Matting Materials** — Conveying with standard components is sometimes possible by the use of special feeding devices at the conveyor inlet.

**Hygroscopic Materials** — Frequently these materials may be handled successfully in a conveyor which is substantially sealed from the exterior atmosphere. In extreme cases it is necessary to provide jacketed trough or housing with an appropriate circulating medium to maintain the material at an elevated temperature. Purging of the conveyor with a suitable dry gas is also used in some installations.

**Viscous or Sticky Materials** — Ribbon flight conveyor screws are most frequently used for conveying these materials although standard components may be specially coated to improve the flow of material.

**Harmful Vapors or Dusts** — These materials may be safely handled in dust sealed trough, plain tubular housing, or gasketed flanged tubular housing with particular attention to shaft sealing. Trough or housing exhaust systems have also been successfully used in some installations.

**Blending in Transit** — Ribbon, cut flight, paddle, or a combination of these screw types may be designed to produce the desired degree of blending, aeration or mixing.

**Explosive Dusts** — The danger of this condition may be minimized in most installations by the use of components which are fabricated from non-ferrous materials and proper conveyor sealing techniques observed. Exhaust systems are also advisable for the removal of explosive dusts.

**Materials Subject to Packing** — This condition requires the use of aerating devices at the conveyor inlet when materials are pulverulent and a special feeder device when material particles are large or fibrous.

**Materials which are Fluid when Aerated** — This condition may be used to advantage in some installations by declining the conveyor system toward the discharge end.

**Degradable Materials** — Some particles that are easily broken or distorted may usually be handled in screw conveyors by reducing the speed and selecting a larger conveyor size sufficient to deliver the required volume of material.

**Elevated Temperature** — Components should be fabricated from high temperature alloys. Should the process be such that cooling of the material in the conveyor is permissible, jacketed trough or housing may be used at the inlet end to cool the material and standard components used after the point where material temperature has been reduced to a safe degree.

# Conveyor Trough

FORMED FLANGE U-TROUGH		Commonly used economical trough. One piece construction. Standard lengths in stock.
ANGLE FLANGE U-TROUGH		Rigid construction. Standard lengths in stock.
FORMED FLANGE TUBULAR TROUGH		Loadable to full cross section for feeder applications. Minimizes fall back in inclined applications. Easily taken apart for maintenance. Can be gasketed for dust tight enclosure. Hanger pockets required for use with standard hangers.
SOLID TUBULAR TROUGH		One piece construction for totally enclosed or inclined applications. Hanger pockets required for use with standard hangers.
FLARED TROUGH		Used where materials tend to bridge or when flared inlets are needed.
CHANNEL TROUGH		Adds structural support for longer than standard spans.
DROP BOTTOM TROUGH		Used when complete material clean-out is critical. Can be furnished with hinges either side and bolts or clamps opposite side.
FORMED FLANGE RECTANGULAR TROUGH		Material being conveyed forms its own trough thereby reducing trough wear. One piece construction.
ANGLE FLANGE RECTANGULAR TROUGH		The same as formed flange rectangular except top flanges are made from structural angle.
JACKETED TROUGH		Jacket allows heating or cooling of material being conveyed.

CONVEYORS



# Standard Conveyor Trough

Standard conveyor troughs have a U-shaped steel body with angle iron top flanges or formed top flanges and jig drilled end flanges.

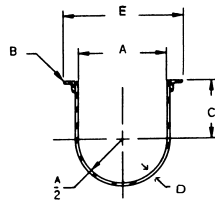
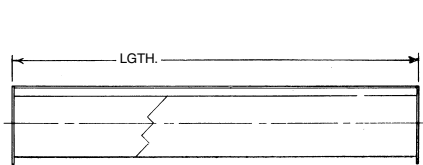

Angle Flange

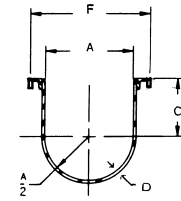

Formed Flange

Conveyor Diameter	D	Angle Flanged	Angle Flanged Trough				Formed Flanged Trough ▲				A	B	C	E	F	
			Weight		Weight		Part Number	Weight		Weight						
			10' Length	5' Length	12' Length	6' Length		10' Length	5' Length	12' Length						6' Length
4	□ 16 GA.	4CTA16	53	29	—	—	4CTF16	41	23	—	—	5	1¼	3⅞	7⅞	7¼
4	14	4CTA14	60	33	—	—	4CTF14	50	28	—	—				7¼	7¼
4	12	4CTA12	78	42	—	—	4CTF12	70	38	—	—				7¼	7¼
6	□ 16 GA.	6CTA16	67	44	—	—	6CTF16	55	32	—	—	7	1¼	4½	9⅞	9¼
6	14	6CTA14	78	49	—	—	6CTF14	67	38	—	—				9¼	9¼
6	12	6CTA12	101	60	—	—	6CTF12	91	50	—	—				9¼	9¼
6	10	6CTA10	123	73	—	—	6CTF10	117	64	—	—				9¼	9¼
6	⅜	6CTA7	164	86	—	—	6CTF7	150	79	—	—				9¼	9¼
9	□ 16 GA.	9CTA16	113	66	—	—	9CTF16	83	51	—	—	10	1½	6⅞	13⅞	13¼
9	14	9CTA14	127	73	—	—	9CTF14	99	59	—	—				13⅞	13¼
9	12	9CTA12	156	87	—	—	9CTF12	132	75	—	—				13¼	13¼
9	10	9CTA10	176	102	—	—	9CTF10	164	91	—	—				13⅞	13¼
9	⅜	9CTA7	230	124	—	—	9CTF7	214	116	—	—				13⅞	13¼
9	¼	9CTA3	286	152	—	—	9CTF3	276	147	—	—				13½	13¼
10	□ 16 GA.	10CTA16	118	69	—	—	10CTF16	88	54	—	—	11	1½	6⅞	14⅞	14¼
10	14	10CTA14	133	76	—	—	10CTF14	105	62	—	—				14⅞	14¼
10	12	10CTA12	164	92	—	—	10CTF12	140	80	—	—				14¼	14¼
10	10	10CTA10	178	102	—	—	10CTF10	167	91	—	—				14⅞	14¼
10	⅜	10CTA7	233	131	—	—	10CTF7	217	123	—	—				14⅞	14¼
10	¼	10CTA3	306	163	—	—	10CTF3	296	158	—	—				14½	14¼
12	□ 12 GA.	12CTA12	197	113	236	135	12CTF12	164	95	197	114	13	2	7¼	17¼	17½
12	10	12CTA10	234	133	281	160	12CTF10	187	117	224	140				17⅞	17½
12	⅜	12CTA7	294	164	353	197	12CTF7	272	150	326	180				17⅞	17½
12	¼	12CTA3	372	203	446	244	12CTF3	357	194	428	233				17½	17½
14	□ 12 GA.	14CTA12	214	121	257	145	14CTF12	183	102	219	122	15	2	9¼	19¼	19⅞
14	10	14CTA10	258	143	309	172	14CTF10	207	127	248	152				19⅞	19⅞
14	⅜	14CTA7	328	180	394	216	14CTF7	304	168	365	202				19⅞	19⅞
14	¼	14CTA3	418	224	501	269	14CTF3	403	215	483	258				19½	19⅞
16	□ 12 GA.	16CTA12	238	133	285	160	16CTF12	206	107	247	128	17	2	10⅞	21¼	21⅞
16	10	16CTA10	288	159	345	191	16CTF10	234	144	281	173				21⅞	21⅞
16	⅜	16CTA7	368	200	442	240	16CTF7	345	188	414	226				21⅞	21⅞
16	¼	16CTA3	471	243	565	291	16CTF3	455	228	546	273				21½	21⅞
18	□ 12 GA.	18CTA12	252	159	302	191	18CTF12	240	133	288	160	19	2½	12⅞	24¼	24½
18	10	18CTA10	353	170	423	204	18CTF10	269	165	323	198				24⅞	24⅞
18	⅜	18CTA7	444	243	533	291	18CTF7	394	217	473	260				24⅞	24⅞
18	¼	18CTA3	559	298	671	358	18CTF3	520	275	624	330				24½	24⅞
20	□ 10 GA.	20CTA10	383	228	460	274	20CTF10	296	190	355	228	21	2½	13½	26⅞	26½
20	⅜	20CTA7	484	271	581	325	20CTF7	434	247	521	296				26⅞	26½
20	¼	20CTA3	612	334	734	401	20CTF3	573	315	687	378				26½	26½
24	□ 10 GA.	24CTA10	443	255	531	306	24CTF10	384	227	461	272	25	2½	16½	30⅞	30½
24	⅜	24CTA7	563	319	676	383	24CTF7	514	293	617	352				30⅞	30½
24	¼	24CTA3	717	363	860	435	24CTF3	678	339	813	406				30½	30½

□ Standard Gauge Bolt Patterns Page H-42

▲ All troughs available in other materials such as stainless, aluminum, abrasion resistant, etc.

▲ Double formed flange standard on all sizes through 10 ga.

CONVEYORS



# Tubular Housing



Tubular conveyor housings are inherently dust and weather-tight, and may be loaded to a full cross section. Conveyors with tubular housings are rigid and are highly suitable for conveying material on an incline. Three types shown are available.

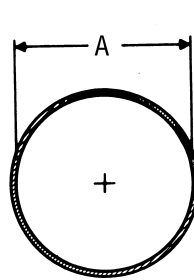

Tubular housing

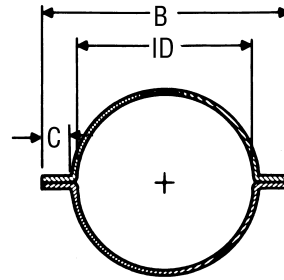

Flanged tubular housing

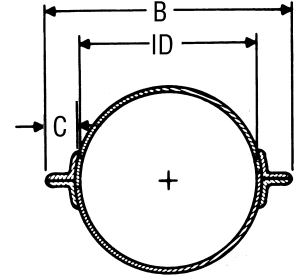

Angle flanged tubular housing

Conveyor Diameter	Trough Thickness	Tubular Housing			Formed Flange		Angle Flange		A	B	C
		Part Number	Weight		Part Number	Weight 10'	Part Number	Weight 10'			
			10' Length	5' Length							
4	□ 16 GA.	4CHT16			4CHT16-F	43	4CHT16-A	81	5	7 7/8 7 1/2 7 1/4	1
4	14	4CHT14			4CHT14-F	53	4CHT14-A	89			
4	12	4CHT12	60	31	4CHT12-F	74	4CHT12-A	106			
6	□ 16 GA.	6CHT16	50	27	6CHT16-F	60	6CHT16-A	110	7	9 5/8 9 1/2 9 1/4 9 3/8 9 1/8	1 1/4
6	14	6CHT14	62	33	6CHT14-F	75	6CHT14-A	122			
6	12	6CHT12	85	44	6CHT12-F	103	6CHT12-A	145			
6	10	6CHT10	109	56	6CHT10-F	133	6CHT10-A	187			
6	3/8	6CHT7	145	74	6CHT7-F	168	6CHT7-A	205			
9	16 GA.	9CHT16	72	39	9CHT16-F	84	9CHT16-A	131	10	12 1/2 12 1/8 12 1/4 12 3/8 12 1/2 13	1 1/4
9	□ 14	9CHT14	89	47	9CHT14-F	104	9CHT14-A	148			
9	12	9CHT12	122	64	9CHT12-F	143	9CHT12-A	181			
9	10	9CHT10	155	80	9CHT10-F	182	9CHT10-A	214			
9	3/8	9CHT7	208	107	9CHT7-F	245	9CHT7-A	267			
9	1/4	9CHT3	275	140	9CHT3-F	324	9CHT3-A	334			
10	16 GA.	10CHT16	79	42	10CHT16-F	91	10CHT16-A	138	11	13 3/8 13 1/8 13 1/4 13 3/16 13 1/2 14	1 1/4
10	□ 14	10CHT14	97	52	10CHT14-F	112	10CHT14-A	156			
10	12	10CHT12	133	70	10CHT12-F	154	10CHT12-A	192			
10	10	10CHT10	169	88	10CHT10-F	196	10CHT10-A	228			
10	3/8	10CHT7	227	117	10CHT7-F	264	10CHT7-A	286			
10	1/4	10CHT3	301	154	10CHT3-F	350	10CHT3-A	360			
12	□ 12 GA.	12CHT12	163	88	12CHT12-F	193	12CHT12-A	235			
12	10	12CHT10	208	111	12CHT10-F	247	12CHT10-A	280			
12	3/8	12CHT7	275	144	12CHT7-F	328	12CHT7-A	347			
12	1/4	12CHT3	362	188	12CHT3-F	432	12CHT3-A	434			
14	□ 12 GA.	14CHT12	187	101	14CHT12-F	217	14CHT12-A	259	15	18 3/4 18 5/8 18 1/2 18 1/4	1 1/2
14	10	14CHT10	236	126	14CHT10-F	275	14CHT10-A	308			
14	3/8	14CHT7	316	166	14CHT7-F	369	14CHT7-A	388			
14	1/4	14CHT3	416	216	14CHT3-F	486	14CHT3-A	488			
16	□ 12 GA.	16CHT12	212	114	16CHT12-F	242	16CHT12-A	310	17	21 1/4 21 5/8 21 1/2 21 1/8	2
16	10	16CHT10	268	142	16CHT10-F	307	16CHT10-A	366			
16	3/8	16CHT7	358	187	16CHT7-F	411	16CHT7-A	456			
16	1/4	16CHT3	472	244	16CHT3-F	542	16CHT3-A	570			
18	□ 12 GA.	18CHT12	242	133	18CHT12-F	280	18CHT12-A	340	19	23 3/4 23 5/8 23 1/2 23 1/4	2
18	10	18CHT10	304	164	18CHT10-F	352	18CHT10-A	402			
18	3/8	18CHT7	405	214	18CHT7-F	471	18CHT7-A	503			
18	1/4	18CHT3	533	278	18CHT3-F	621	18CHT3-A	631			
20	□ 10 GA.	20CHT10	335	188	20CHT10-F	381	20CHT10-A	433	21	25 5/8 25 1/2 25 1/4	2
20	3/8	20CHT7	446	237	20CHT7-F	510	20CHT7-A	544			
20	1/4	20CHT3	586	307	20CHT3-F	671	20CHT3-A	684			
24	□ 10 GA.	24CHT10	399	215	24CHT10-F	445	24CHT10-A	497	25	29 5/8 29 1/2 29 1/4	2
24	3/8	24CHT7	531	281	24CHT7-F	594	24CHT7-A	629			
24	1/4	24CHT3	699	365	24CHT3-F	784	24CHT3-A	797			

□ Standard Gauge  
For Bolt Patterns See Page H-43

CONVEYORS





# Flared Trough

Flared troughs are used primarily to convey materials which are not free-flowing or which have a tendency to stick to the trough.

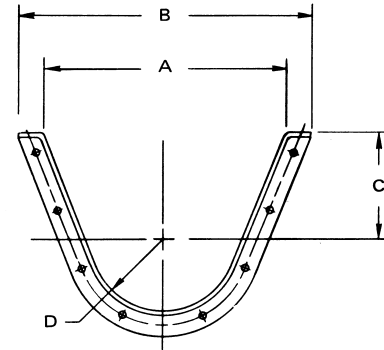
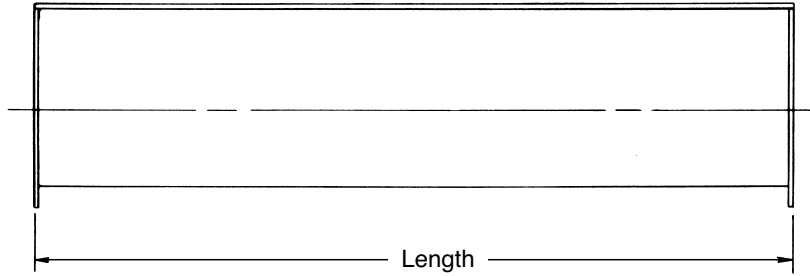

Conveyor Diameter	Trough Thickness	Part Number	Weight Per Foot	A	B	C	D	Standard Length Foot																																																																																																																																																															
6	□ 14 GA.	6FCT14	9	14	16 <sup>5</sup> / <sub>16</sub>	7	3 <sup>1</sup> / <sub>2</sub>	10																																																																																																																																																															
6	12	6FCT12	12		16 <sup>5</sup> / <sub>16</sub>				9	□ 14 GA.	9FCT14	13	18	21 <sup>1</sup> / <sub>16</sub>	9	5	10	9	12 GA.	9FCT12	14	21 <sup>1</sup> / <sub>4</sub>	9	10	9FCT10	19	21 <sup>1</sup> / <sub>4</sub>	9	<sup>3</sup> / <sub>16</sub>	9FCT7	22	21 <sup>1</sup> / <sub>4</sub>	9	<sup>1</sup> / <sub>4</sub>	9FCT3	25	21 <sup>1</sup> / <sub>2</sub>	12	□ 12 GA.	12FCT12	20	22	26 <sup>1</sup> / <sub>4</sub>	10	6 <sup>1</sup> / <sub>2</sub>	12	12	10	12FCT10	24	26 <sup>1</sup> / <sub>4</sub>	12	<sup>3</sup> / <sub>16</sub>	12FCT7	32	26 <sup>1</sup> / <sub>4</sub>	12	<sup>1</sup> / <sub>4</sub>	12FCT3	43	26 <sup>1</sup> / <sub>2</sub>	14	□ 12 GA.	14FCT12	23	24	28 <sup>1</sup> / <sub>4</sub>	11	7 <sup>1</sup> / <sub>2</sub>	12	14	10	14FCT10	27	28 <sup>1</sup> / <sub>4</sub>	14	<sup>3</sup> / <sub>16</sub>	14FCT7	37	28 <sup>1</sup> / <sub>4</sub>	14	<sup>1</sup> / <sub>4</sub>	14FCT3	49	28 <sup>1</sup> / <sub>2</sub>	16	□ 12 GA.	16FCT12	25	28	32 <sup>1</sup> / <sub>4</sub>	11 <sup>1</sup> / <sub>2</sub>	8 <sup>1</sup> / <sub>2</sub>	12	16	10	16FCT10	31	32 <sup>1</sup> / <sub>4</sub>	16	<sup>3</sup> / <sub>16</sub>	16FCT7	39	32 <sup>1</sup> / <sub>4</sub>	16	<sup>1</sup> / <sub>4</sub>	16FCT3	52	32 <sup>1</sup> / <sub>2</sub>	18	□ 12 GA.	18FCT12	27	31	36 <sup>1</sup> / <sub>4</sub>	12 <sup>1</sup> / <sub>2</sub>	9 <sup>1</sup> / <sub>2</sub>	12	18	10	18FCT10	35	36 <sup>1</sup> / <sub>4</sub>	18	<sup>3</sup> / <sub>16</sub>	18FCT7	45	36 <sup>1</sup> / <sub>4</sub>	18	<sup>1</sup> / <sub>4</sub>	18FCT3	56	36 <sup>1</sup> / <sub>2</sub>	20	□ 10 GA.	20FCT10	36	34	39 <sup>1</sup> / <sub>4</sub>	13 <sup>1</sup> / <sub>2</sub>	10 <sup>1</sup> / <sub>2</sub>	12	20	<sup>3</sup> / <sub>16</sub>	20FCT7	48	39 <sup>1</sup> / <sub>4</sub>	20	<sup>1</sup> / <sub>4</sub>	20FCT3	60	39 <sup>1</sup> / <sub>2</sub>	24	□ 10 GA.	24FCT10	41	40	45 <sup>1</sup> / <sub>4</sub>	16 <sup>1</sup> / <sub>2</sub>	12 <sup>1</sup> / <sub>2</sub>	12	24	<sup>3</sup> / <sub>16</sub>	24FCT7	54	45 <sup>1</sup> / <sub>4</sub>	24
9	□ 14 GA.	9FCT14	13	18	21 <sup>1</sup> / <sub>16</sub>	9	5	10																																																																																																																																																															
9	12 GA.	9FCT12	14		21 <sup>1</sup> / <sub>4</sub>																																																																																																																																																																		
9	10	9FCT10	19		21 <sup>1</sup> / <sub>4</sub>																																																																																																																																																																		
9	<sup>3</sup> / <sub>16</sub>	9FCT7	22		21 <sup>1</sup> / <sub>4</sub>																																																																																																																																																																		
9	<sup>1</sup> / <sub>4</sub>	9FCT3	25		21 <sup>1</sup> / <sub>2</sub>																																																																																																																																																																		
12	□ 12 GA.	12FCT12	20	22	26 <sup>1</sup> / <sub>4</sub>	10	6 <sup>1</sup> / <sub>2</sub>	12																																																																																																																																																															
12	10	12FCT10	24		26 <sup>1</sup> / <sub>4</sub>																																																																																																																																																																		
12	<sup>3</sup> / <sub>16</sub>	12FCT7	32		26 <sup>1</sup> / <sub>4</sub>																																																																																																																																																																		
12	<sup>1</sup> / <sub>4</sub>	12FCT3	43		26 <sup>1</sup> / <sub>2</sub>																																																																																																																																																																		
14	□ 12 GA.	14FCT12	23	24	28 <sup>1</sup> / <sub>4</sub>	11	7 <sup>1</sup> / <sub>2</sub>	12																																																																																																																																																															
14	10	14FCT10	27		28 <sup>1</sup> / <sub>4</sub>																																																																																																																																																																		
14	<sup>3</sup> / <sub>16</sub>	14FCT7	37		28 <sup>1</sup> / <sub>4</sub>																																																																																																																																																																		
14	<sup>1</sup> / <sub>4</sub>	14FCT3	49		28 <sup>1</sup> / <sub>2</sub>																																																																																																																																																																		
16	□ 12 GA.	16FCT12	25	28	32 <sup>1</sup> / <sub>4</sub>	11 <sup>1</sup> / <sub>2</sub>	8 <sup>1</sup> / <sub>2</sub>	12																																																																																																																																																															
16	10	16FCT10	31		32 <sup>1</sup> / <sub>4</sub>																																																																																																																																																																		
16	<sup>3</sup> / <sub>16</sub>	16FCT7	39		32 <sup>1</sup> / <sub>4</sub>																																																																																																																																																																		
16	<sup>1</sup> / <sub>4</sub>	16FCT3	52		32 <sup>1</sup> / <sub>2</sub>																																																																																																																																																																		
18	□ 12 GA.	18FCT12	27	31	36 <sup>1</sup> / <sub>4</sub>	12 <sup>1</sup> / <sub>2</sub>	9 <sup>1</sup> / <sub>2</sub>	12																																																																																																																																																															
18	10	18FCT10	35		36 <sup>1</sup> / <sub>4</sub>																																																																																																																																																																		
18	<sup>3</sup> / <sub>16</sub>	18FCT7	45		36 <sup>1</sup> / <sub>4</sub>																																																																																																																																																																		
18	<sup>1</sup> / <sub>4</sub>	18FCT3	56		36 <sup>1</sup> / <sub>2</sub>																																																																																																																																																																		
20	□ 10 GA.	20FCT10	36	34	39 <sup>1</sup> / <sub>4</sub>	13 <sup>1</sup> / <sub>2</sub>	10 <sup>1</sup> / <sub>2</sub>	12																																																																																																																																																															
20	<sup>3</sup> / <sub>16</sub>	20FCT7	48		39 <sup>1</sup> / <sub>4</sub>																																																																																																																																																																		
20	<sup>1</sup> / <sub>4</sub>	20FCT3	60		39 <sup>1</sup> / <sub>2</sub>																																																																																																																																																																		
24	□ 10 GA.	24FCT10	41	40	45 <sup>1</sup> / <sub>4</sub>	16 <sup>1</sup> / <sub>2</sub>	12 <sup>1</sup> / <sub>2</sub>	12																																																																																																																																																															
24	<sup>3</sup> / <sub>16</sub>	24FCT7	54		45 <sup>1</sup> / <sub>4</sub>																																																																																																																																																																		
24	<sup>1</sup> / <sub>4</sub>	24FCT3	69		45 <sup>1</sup> / <sub>2</sub>																																																																																																																																																																		

□ Standard Gauge

See Page H-42 for Bolt Pattern

CONVEYORS

# Discharges and Gates



## Discharge Spout Index

14	TSD	12
----	-----	----

Conveyor Diameter

TSD - Plain, Fixed Spout  
 TSDS - Plain Fixed Spout W/Slide  
 TSDF - Flush End Spout  
 RPF - Rack & Pinion/Flat Side

Types

RPF - Rack & Pinion/Flat Slide DustTight  
 RPC - Rack & Pinion/Curved Slide  
 RPCD - Rack & Pinion/Curved Slide DustTight

Spout Thickness

14 - 14 Gauge  
 12 - 12 Gauge  
 10 - 10 Gauge  
 7 - 3/16

STANDARD DISCHARGE SPOUT		<p>Most commonly used.                  Flanged hole drilling is per CEMA Standards.                  Select spout thickness according to trough thickness.</p>
STANDARD DISCHARGE SPOUT WITH HAND SLIDE		<p>Standard spout shown above with the addition of the slide and side guides.                  Select spout thickness according to trough thickness.</p>
FLUSH END DISCHARGE SPOUT		<p>Reduces distance from centerline of discharge to end of the conveyor which eliminates ledge at end of trough and product build-up. Special flush-end trough ends required when this style of discharge is used.</p>
FLAT SLIDE GATE		<p>Rack &amp; pinion type available with hand wheel, rope wheel, pocket wheel and chain. Discharge spout is included when fitted.                  Flat slide (less rack &amp; pinion) can be furnished with pneumatic, hydraulic, or electric actuators.                  (Not dust-tight).</p>
CURVED SLIDE GATE		<p>Contoured shape of slide eliminates pocket found in flat slide type.                  Rack &amp; pinion type available with handwheel, or rope wheel, or pocket wheel with chain.                  Curved slide (less rack &amp; pinion) can be furnished with pneumatic, hydraulic, or electric actuators.                  (Standard curved slide gate is not dust-tight.)                  All curved slide gates should be <u>installed at factory</u>.</p>
DUST TIGHT RACK AND PINION FLAT SLIDE		<p>Dust tight rack and pinions are totally enclosed and can be furnished with either flat or curved slide. Handwheel is normally furnished but is also available with chain or rope wheel.</p>

CONVEYORS



# Discharge Spouts

## Plain Opening

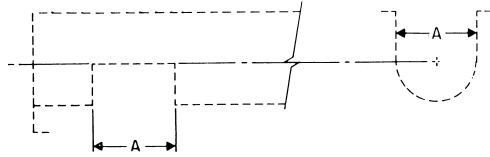

Plain spout openings are cut in the trough permitting free material discharge.

## Fixed Spout with Slide Gate

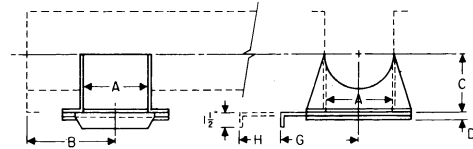

Fixed spouts with slide gates are used where distribution of material is to be controlled. Bolted flange permits slide to be operated from any side.

## Fixed Spout

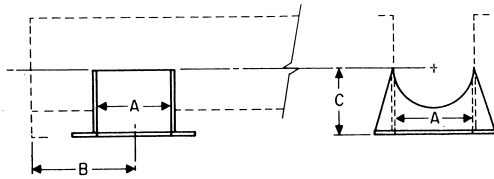

Fixed spouts are fabricated in proportion to size and thickness of trough. Can be furnished loose or welded to trough.

## Flush End Spout

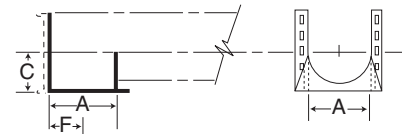

Flush end discharge spouts are designed for use at the final discharge point. The end of the spout is comprised of a housing end with bottom flange drilled with standard discharge flange bolt pattern. Because it is located at the extreme end of the conveyor, there is no carryover of material past the final discharge point. The flush end arrangement eliminates the unnecessary extension of trough and interior components beyond the actual discharge point.

Screw Diameter	A	B	C	D	G	H	F
4	5	4½	3¾	⅜	5%	11	2½
6	7	6	5	⅜	6%	14	3½
9	10	8	7%	⅜	8	19	5
10	11	9	7%	⅜	8%	20	5½
12	13	10½	8%	⅜	10%	24	6½
14	15	11½	10%	⅜	11¼	27	7½
16	17	13½	11%	⅜	12%	30	8½
18	19	14½	12%	⅜	13%	33	9½
20	21	15½	13%	⅜	14%	36	10½
24	25	17½	15%	⅜	16%	42	12½

Screw Diameter	Trough Thickness Gauge	Spout and Gate Thickness Gauge	Part Number			Weight		
			Fixed Spout		Flush End Spout	Fixed Spout		Flush End Spout
			Plain	With Slide		Plain	Slide	
4	16-14	□ 14	4TSD14	4TSDS14	4TSDF14	2	6	1.5
4	12	12	4TSD12	4TSDS12	4TSDF12	3	7	2.25
6	14-12	□ 14	6TSD14	6TSDS14	6TSDF14	4	11	3.0
6	⅜	12	6TSD12	6TSDS12	6TSDF12	6	13	4.50
9	16-14-12-10	□ 14	9TSD14	9TSDS14	9TSDF14	8	18	6.0
9	⅜-¼	10	9TSD10	9TSDS10	9TSDF10	13	22	9.75
10	14-12-10	□ 14	10TSD14	10TSDS14	10TSDF14	10	21	7.5
10	⅜-¼	10	10TSD10	10TSDS10	10TSDF10	16	27	12.0
12	12-10	□ 12	12TSD12	12TSDS12	12TSDF12	17	36	12.75
12	⅜-¼	⅜	12TSD7	12TSDS7	12TSDF7	29	48	21.75
14	12-10	□ 12	14TSD12	14TSDS12	14TSDF12	22	46	16.50
14	⅜-¼	⅜	14TSD7	14TSDS7	14TSDF7	38	62	28.50
16	12-10	□ 12	16TSD12	16TSDS12	16TSDF12	21	49	15.75
16	⅜-¼	⅜	16TSD7	16TSDS7	16TSDF7	40	68	30.0
18	12-10	□ 12	18TSD12	18TSDS12	18TSDF12	32	69	24.0
18	⅜-¼	⅜	18TSD7	18TSDS7	18TSDF7	60	97	45.0
20	10	□ 12	20TSD12	20TSDS12	20TSDF12	40	91	30.0
20	⅜-¼	⅜	20TSD7	20TSDS7	20TSDF7	67	118	50.25
24	10	□ 12	24TSD12	24TSDS12	24TSDF12	52	116	39.0
24	⅜-¼	⅜	24TSD7	24TSDS7	24TSDF7	87	151	65.25

□ Standard Gauge  
For Bolt Patterns See Page H-43

① Add -F for Fitted

CONVEYORS

# Discharge Gates



Flat rack and pinion slide gates can be bolted to standard discharge spouts at any of the four positions desired. Hand wheel is normally furnished but is also available with chain or rope wheel.

## Rack and Pinion Flat Slide

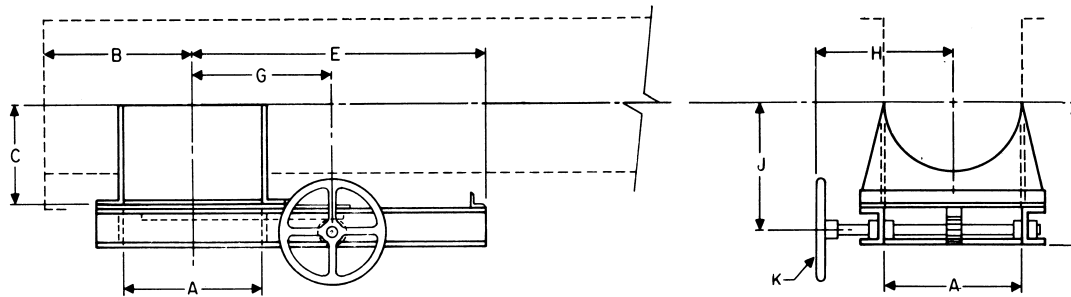

Screw Diameter	A	B	C	D	E	G	H	J	K Diameter
4	5	4½	3¾	7	13½	6½	5	5½	12
6	7	6	5	8¾	16	7½	6	6¾	12
9	10	8	7½	10½	20¼	9	9½	8½	12
10	11	9	7½	11¼	23½	10½	10	9½	12
12	13	10½	8½	12¼	25½	11	12¼	10½	12
14	15	11½	10½	13¾	31¼	12½	13¼	12	12
16	17	13½	11½	14¾	33¾	13½	14¼	13	12
18	19	14½	12¾	15¾	37¾	14½	15¾	14½	12
20	21	15½	13¾	16½	40¾	15½	16¾	15½	12
24	25	17½	15¾	18½	46½	17½	18¾	17½	12

Screw Diameter	Trough Thickness Gauge	Spout and Gate Thickness Gauge	Part Number Rack and Pinion† ①	Weight Rack and Pinion
4	16-14	□ 14	4RPF14	18
4	12	12	4RPF12	21
6	16-14-12	□ 14	6RPF14	28
6	⅜	12	6RPF12	31
9	14-12-10	□ 14	9RPF14	49
9	⅜-¼	10	9RPF10	54
10	14-12-10	□ 14	10RPF14	56
10	⅜-¼	10	10RPF10	62
12	12-10	□ 12	12RPF12	94
12	⅜-¼	⅜	12RPF7	106
14	12-10	□ 12	14RPF12	107
14	⅜-¼	⅜	14RPF7	123
16	12-10	□ 12	16RPF12	112
16	⅜-¼	⅜	16RPF7	131
18*	12-10	□ 12	18RPF12	157
18*	⅜-¼	⅜	18RPF7	185
20*	10	□ 12	20RPF12	185
20*	⅜-¼	⅜	20RPF7	212
24*	10	□ 12	24RPF12	233
24*	⅜-¼	⅜	24RPF7	268

\* Handwheel supplied as Standard Assembly  
 - C Chain Wheel  
 - R Rope Wheel

□ Standard Gauge  
 For Bolt Patterns See Page H-43

† All Rack & Pinion Gates 18" and Larger Have Double Rack & Pinion.

① Add -F for Fitted

CONVEYORS



# Discharge Gates

## Rack and Pinion Curved Slide

Curved rack and pinion slide gates are contoured to the shape of the trough thus eliminating pocket caused by flat slide. Slide operates parallel to the trough only. Hand wheel is normally furnished but is also available with chain or rope wheel.

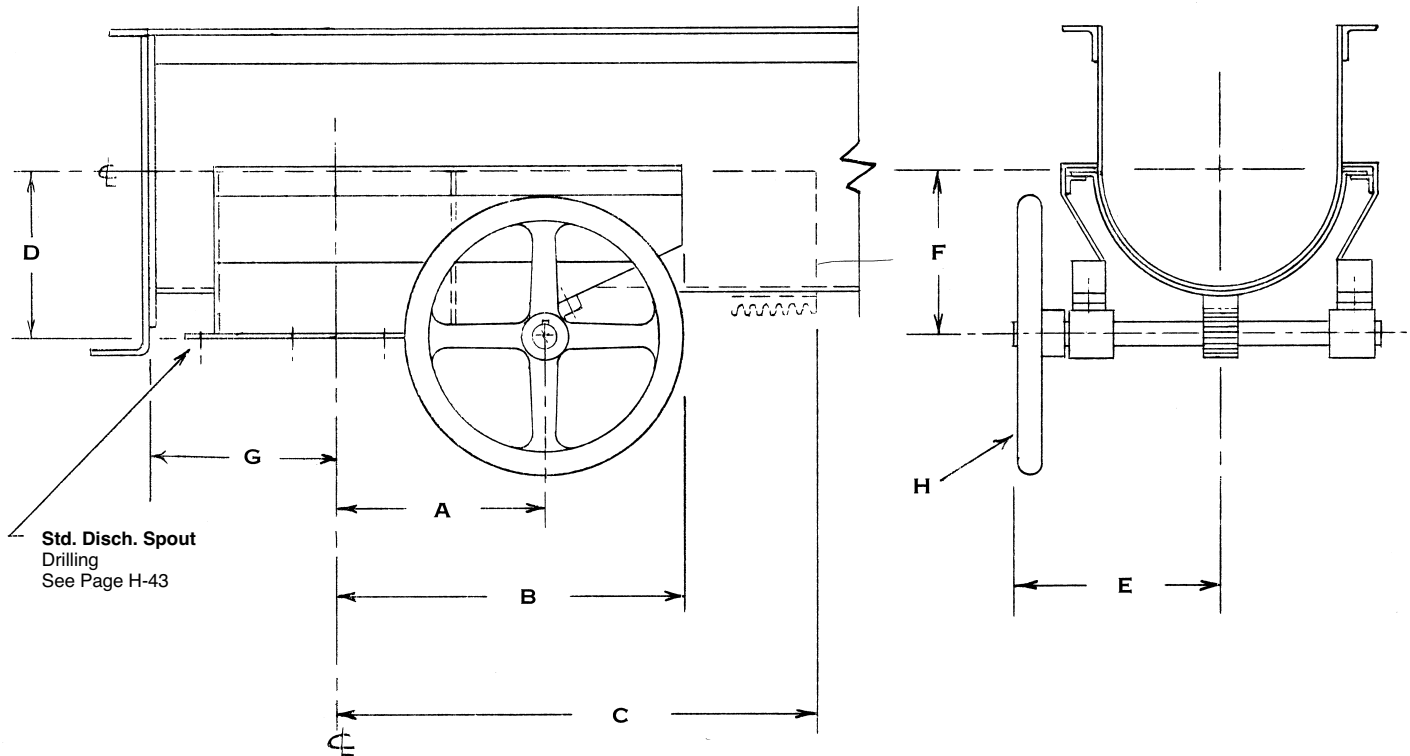

Conveyor Diameter	Trough Thickness	Spout Thickness	Part Number* <sup>①</sup>	Weight Pounds	A	B	C	D	E	F	G	H Diameter
4	14,16 Cal.	□ 14 Cal.	4RPC14	20	6¼	8¼	12	3¼	6	4½	4½	12
4	12 Cal.	12 GA.	4RPC12	22	6¼	8¼	12	3¼	6	4%	4%	12
6	16,14,12 GA.	□ 14 GA.	6RPC14	25	7½	10½	15	5	8	5½	6	12
6	¾", ¼"	12 GA.	6RPC12	28	7½	10½	15	5	8	5%	5%	12
9	14,12,10 GA.	□ 14 GA.	9RPC14	46	9	15	20½	7½	8¼	7	8	12
9	¾", ¼"	10 GA.	9RPC10	54	9	15	20½	7½	8¼	7½	8	12
10	14,12,10 GA.	□ 14 GA.	10RPC14	53	9½	14½	21	7½	9½	7½	9	12
10	¾", ¼"	10 GA.	10RPC10	62	9½	14½	21	7½	9½	7%	9	12
12	12,10 GA.	□ 12 GA.	12RPC12	81	11½	17½	25¼	8%	11	8½	10½	12
12	¾", ¼"	¾"	12RPC7	97	11½	17½	25¼	8%	11	8%	10½	12
14	10,12 GA.	□ 12 GA.	14RPC12	95	12%	20½	30¼	10%	12	9½	11½	12
14	¾", ¼"	¾"	14RPC7	114	12%	20½	30¼	10%	12	9%	11½	12
16	10,12 GA.	□ 12 GA.	16RPC12	103	14%	23½	36	11%	13	10½	13½	12
16	¾", ¼"	¾"	16RPC7	116	14%	23½	36	11%	13	10%	13½	12
18	10,12 GA.	□ 12 GA.	18RPC12	157	15%	25½	37¼	12%	15%	11½	14½	12
18	¾", ¼"	¾"	18RPC7	187	15%	25½	37¼	12%	15%	11%	14½	12
20	12 GA.	□ 12 GA.	20RPC12	175	17%	28½	39	13%	16%	12½	15½	12
20	¾", ¼"	¾"	20RPC7	208	17%	28½	39	13%	16%	12%	15½	12
24	10 GA.	□ 12 GA.	24RPC12	220	19%	35½	47	15%	18%	14½	17½	12
24	¾", ¼"	¾"	24RPC7	265	19%	35½	47	15%	18%	14%	17½	12

\* Hand wheel supplied as Standard Assembly  
 - C Chain Wheel  
 - R Rope Wheel

□ Standard Gauge

① Add -F for Fitted

CONVEYORS

# Discharge Gates



## Dust Tight Rack and Pinion Flat Slide

Dust tight rack and pinions are totally enclosed and can be furnished with either flat or curved slide. Handwheel is normally furnished but is also available with chain or rope wheel.

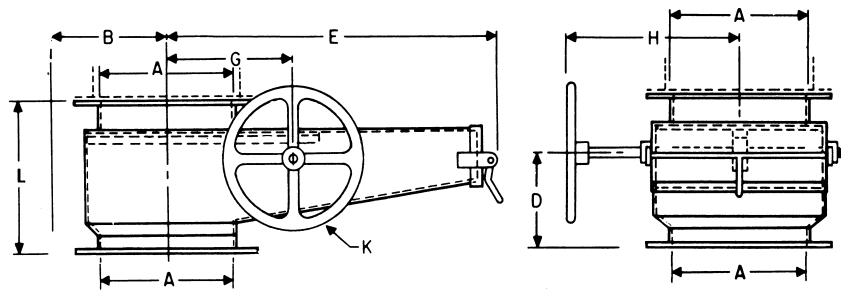

## Dust Tight Rack and Pinion Curved Slide

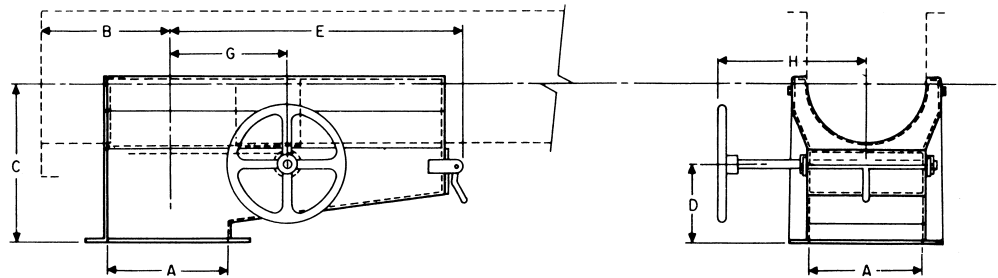

Screw Diameter	A	B	C	D	E	G	H	K Diameter	L
4	5	4½	7½	2½	12	6	7	12	7½
6	7	6	10	4	18½	7½	8	12	9
9	10	8	12½	5	23	9	11	12	10
10	11	9	13	5	25	10	11½	12	10½
12	13	10½	15	5	28	11½	13	12	10½
14	15	11½	15½	5½	31	12½	14	12	10½
16	17	13½	16½	5½	34	13½	15	12	10½
18	19	14½	18½	6½	38½	15	16½	12	11½
20	21	15½	20	7	40½	16	17½	12	12
24	25	17½	23	8	47½	18	19½	12	13

Screw Diameter	Trough Thickness Gauge	Spout and Slide Thickness Gauge	Part Number			
			Flat Slide * ①	Weight	Curved Slide * ①	Weight
4	16-14	14	4RPF14	27	4RPCD16	30
4	12	12	4RPF12	32	4RPCD12	35
6	16-14-12	14	6RPF14	42	6RPCD16	46
6	¾	12	6RPF12	47	6RPCD12	52
9	14-12-10	14	9RPF12	74	9RPCD12	81
9	⅜-¼	10	9RPF10	81	9RPCD10	89
10	14-12-10	14	10RPF14	84	10RPCD14	92
10	⅜-¼	10	10RPF10	93	10RPCD10	102
12	12-10	12	12RPF12	141	12RPCD12	155
12	⅜-¼	¾	12RPF7	158	12RPCD7	174
14	12-10	12	14RPF12	160	14RPCD12	176
14	⅜-¼	¾	14RPF7	185	14RPCD7	204
16	12-10	12	16RPF12	168	16RPCD12	185
16	⅜-¼	¾	16RPF7	197	16RPCD7	217
18	12-10	12	18RPF12	240	18RPCD12	264
18	⅜-¼	¾	18RPF7	277	18RPCD7	305
20	10	12	20RPF12	278	20RPCD12	306
20	⅜-¼	¾	20RPF7	318	20RPCD7	350
24	10	12	24RPF12	350	24RPCD12	385
24	⅜-¼	¾	24RPF7	402	24RPCD7	442

\* Handwheel supplied as standard assembly  
 - C Chain Wheel  
 - R Rope Wheel

Flange drilling is standard. See page H-43  
 ① Add -F for Fitted

CONVEYORS



# Discharge Gate Accessories

## Hand Wheel

Dimensions in Inches and Weight in Pounds

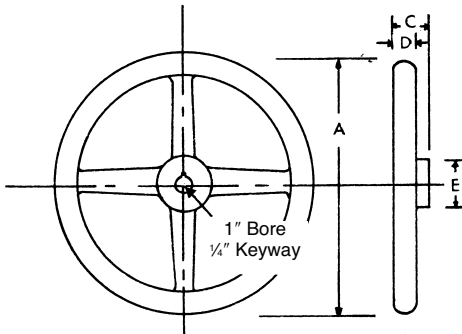

Wheel Diameter	Part No.	Weight	C	D	E
12	12HW1	11	2	1½	1½

The hand wheel is regularly furnished to rotate the pinion shaft when the slide gate is readily accessible.

NOTE: Zinc or nickel plated hand wheels available on request.

## Pocket Wheel & Rope Wheel

Dimensions in Inches and Average Weights in Pounds

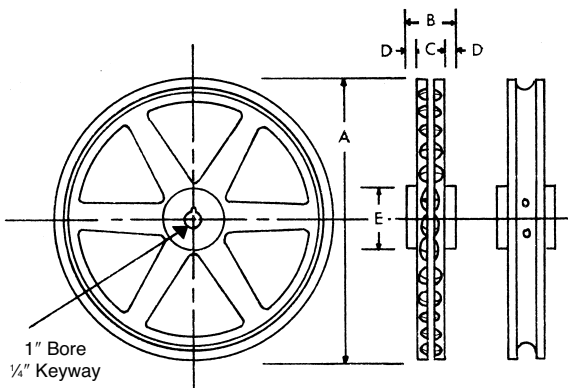

Wheel Diameter	Part No.	Weight	A	B	C	D	E
Chain Wheel	20PW1	11	12¾	2	1½	¾	2
Rope Wheel	12RW1	13	12¾	2¼	1½	1¼	1½

Pocket chain and rope wheels are used to rotate pinion shaft where remote operation is desired. It is designed to be used with number ¾ pocket chain.

NOTE: Zinc or nickel plated hand wheels available on request.

316 PC Pocket Chain in Stock

## Hanger Pockets

Hanger pockets are used with tubular trough and are mounted on the trough at bearing connections. The hanger pocket forms a "U" shaped section for a short distance, allowing the use of standard hangers and providing easy access to them.

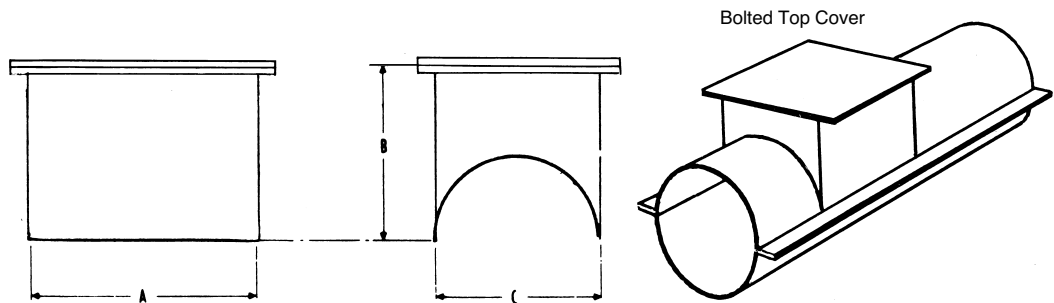

Conveyor Diameter	Part Number	A	B	C	Weight Each
4	4CPH16	8	3¾	5	2
6	6CPH16	12	4¾	7	3
9	9CPH14	12	6¾	10	4
10	10CPH14	12	6¾	11	9
12	12CPH12	18	8	13	18
14	14CPH12	18	9½	15	24
16	16CPH12	18	10¾	17	26
18	18CPH12	18	12¾	19	55
20	20CPH10	18	13¾	21	70
24	24CPH10	18	16¾	25	85

CONVEYORS

# Trough Ends

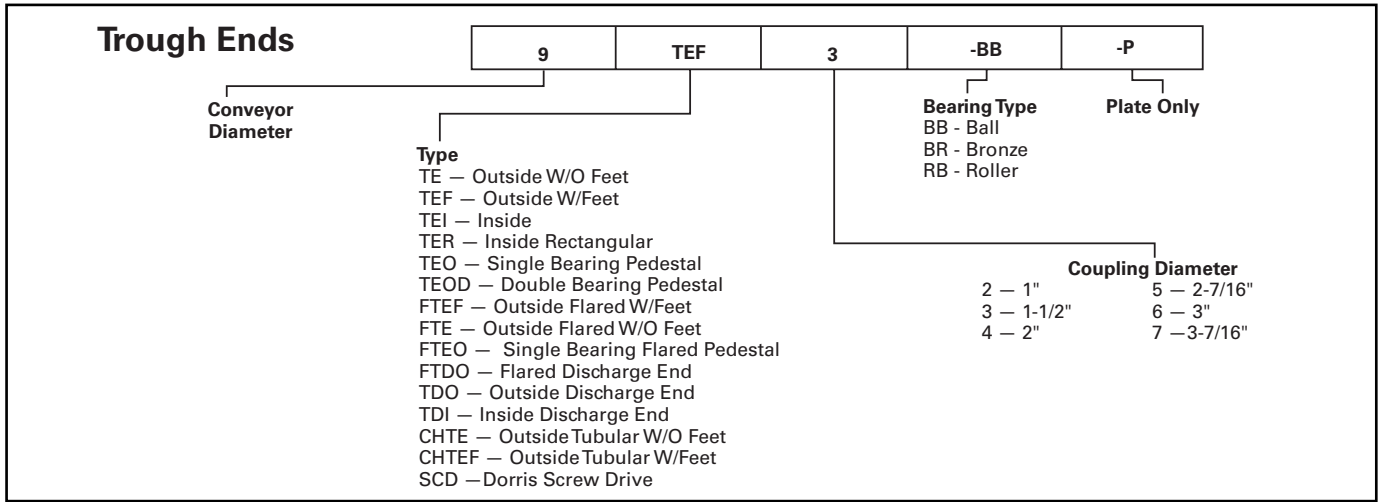

CONVEYORS

	U-TROUGH	TUBULAR TROUGH	FLARED TROUGH	RECTANGULAR TROUGH	
OUTSIDE TROUGH ENDS WITH FEET					Most common type used as trough support is included.
OUTSIDE TROUGH ENDS WITHOUT FEET					Trough support not included.
INSIDE PATTERN TROUGH ENDS		Available on application	Available on application		Used where space is limited or trough does not have end flange.
DISCHARGE TROUGH ENDS		Available on application			For end discharge conveyors. Special flange bearing required.
OUTBOARD BEARING TROUGH ENDS SINGLE					Used when compression type packing gland seal or split gland seal required.





# Trough Ends

## Outside Less Feet

Outside trough ends less feet are used to support end bearing and cover when no trough support is required. Drilling for bronze bearing or flanged ball bearing is standard.

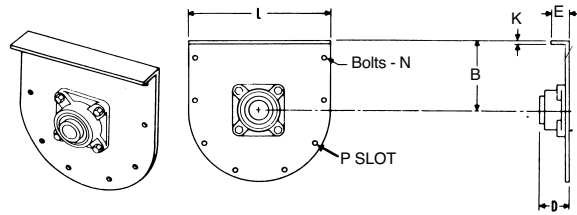

Conveyor Diameter	Shaft Diameter	▲ Part Number	B	D			E	K	L	N	Weight	P Slot
				Friction Bearing	Ball Bearing	Roller Bearing						
4	1	4TE2-*	3 <sup>3</sup> / <sub>8</sub>	2 <sup>5</sup> / <sub>16</sub>	1 <sup>5</sup> / <sub>8</sub>		1 <sup>1</sup> / <sub>16</sub>	1/4	8 <sup>3</sup> / <sub>8</sub>	3/8	3	7/16 x 9/16
6	1 1/2	6TE3-*	4 1/2	3 <sup>3</sup> / <sub>16</sub>	2 <sup>3</sup> / <sub>16</sub>	3 <sup>1</sup> / <sub>16</sub>	1 1/2	1/4	10 <sup>3</sup> / <sub>8</sub>	3/8	4	7/16 x 9/16
9	1 1/2	9TE3-*	6 <sup>3</sup> / <sub>8</sub>	3 <sup>3</sup> / <sub>4</sub>	2 <sup>3</sup> / <sub>16</sub>	3 <sup>1</sup> / <sub>16</sub>	1 <sup>5</sup> / <sub>8</sub>	1/4	13 <sup>3</sup> / <sub>8</sub>	3/8	9	7/16 x 9/16
	2	9TE4-*	6 <sup>3</sup> / <sub>8</sub>	4 <sup>1</sup> / <sub>4</sub>	2 <sup>1</sup> / <sub>2</sub>	3 <sup>3</sup> / <sub>16</sub>	1 <sup>5</sup> / <sub>8</sub>	1/4	13 <sup>3</sup> / <sub>8</sub>	3/8	9	7/16 x 9/16
10	1 1/2	10TE3-*	6 <sup>3</sup> / <sub>8</sub>	3 <sup>3</sup> / <sub>4</sub>	2 <sup>3</sup> / <sub>16</sub>	3 <sup>1</sup> / <sub>16</sub>	1 <sup>3</sup> / <sub>4</sub>	1/4	14 <sup>3</sup> / <sub>8</sub>	3/8	11	7/16 x 9/16
	2	10TE4-*	6 <sup>3</sup> / <sub>8</sub>	4 <sup>1</sup> / <sub>4</sub>	2 <sup>1</sup> / <sub>2</sub>	3 <sup>3</sup> / <sub>16</sub>	1 <sup>3</sup> / <sub>4</sub>	1/4	14 <sup>3</sup> / <sub>8</sub>	3/8	11	7/16 x 9/16
12	2	12TE4-*	7 <sup>3</sup> / <sub>4</sub>	4 <sup>1</sup> / <sub>4</sub>	2 <sup>5</sup> / <sub>16</sub>	3 <sup>3</sup> / <sub>8</sub>	2	1/4	17 <sup>1</sup> / <sub>4</sub>	1/2	20	9/16 x 1 <sup>1</sup> / <sub>16</sub>
	2 1/2	12TE5-*	7 <sup>3</sup> / <sub>4</sub>	5 <sup>1</sup> / <sub>4</sub>	2 <sup>5</sup> / <sub>16</sub>	4 <sup>1</sup> / <sub>16</sub>	2	1/4	17 <sup>1</sup> / <sub>4</sub>	1/2	20	9/16 x 1 <sup>1</sup> / <sub>16</sub>
	3	12TE6-*	7 <sup>3</sup> / <sub>4</sub>	6 <sup>1</sup> / <sub>4</sub>	3 <sup>3</sup> / <sub>4</sub>	4 <sup>1</sup> / <sub>16</sub>	2	1/4	17 <sup>1</sup> / <sub>4</sub>	1/2	20	9/16 x 1 <sup>1</sup> / <sub>16</sub>
14	2 1/2	14TE5-*	9 <sup>1</sup> / <sub>4</sub>	5 <sup>5</sup> / <sub>16</sub>	2 <sup>5</sup> / <sub>16</sub>	4 <sup>1</sup> / <sub>16</sub>	2	1/4	19 <sup>1</sup> / <sub>4</sub>	1/2	35	9/16 x 1 <sup>1</sup> / <sub>16</sub>
	3	14TE6-*	9 <sup>1</sup> / <sub>4</sub>	5 <sup>5</sup> / <sub>16</sub>	3 <sup>3</sup> / <sub>4</sub>	4 <sup>1</sup> / <sub>16</sub>	2	1/4	19 <sup>1</sup> / <sub>4</sub>	1/2	35	9/16 x 1 <sup>1</sup> / <sub>16</sub>
16	3	16TE6-*	10 <sup>3</sup> / <sub>8</sub>	6 <sup>5</sup> / <sub>16</sub>	3 <sup>3</sup> / <sub>16</sub>	5	2 1/2	5/16	21 <sup>1</sup> / <sub>4</sub>	5/8	42	1 <sup>1</sup> / <sub>16</sub> x 1 <sup>3</sup> / <sub>16</sub>
	3	18TE6-*	12 <sup>1</sup> / <sub>2</sub>	6 <sup>3</sup> / <sub>4</sub>	3 <sup>3</sup> / <sub>16</sub>	5	2 1/2	3/8	24 <sup>1</sup> / <sub>4</sub>	5/8	60	1 <sup>1</sup> / <sub>16</sub> x 1 <sup>3</sup> / <sub>16</sub>
18	3	18TE6-*	12 <sup>1</sup> / <sub>2</sub>	7 <sup>3</sup> / <sub>8</sub>	4 <sup>3</sup> / <sub>16</sub>	5 <sup>3</sup> / <sub>16</sub>	2 1/2	3/8	24 <sup>1</sup> / <sub>4</sub>	5/8	60	1 <sup>1</sup> / <sub>16</sub> x 1 <sup>3</sup> / <sub>16</sub>
	3 1/2	18TE7-*	12 <sup>1</sup> / <sub>2</sub>	7 <sup>3</sup> / <sub>8</sub>	4 <sup>3</sup> / <sub>16</sub>	5 <sup>3</sup> / <sub>16</sub>	2 1/2	3/8	24 <sup>1</sup> / <sub>4</sub>	5/8	60	1 <sup>1</sup> / <sub>16</sub> x 1 <sup>3</sup> / <sub>16</sub>
20	3	20TE6-*	13 <sup>1</sup> / <sub>2</sub>	6 <sup>3</sup> / <sub>4</sub>	3 <sup>3</sup> / <sub>4</sub>	5 <sup>5</sup> / <sub>16</sub>	2 1/2	3/8	26 <sup>3</sup> / <sub>8</sub>	5/8	90	1 <sup>1</sup> / <sub>16</sub> x 1 <sup>3</sup> / <sub>16</sub>
	3 1/2	20TE7-*	13 <sup>1</sup> / <sub>2</sub>	7 <sup>3</sup> / <sub>8</sub>	4 <sup>3</sup> / <sub>4</sub>	5 <sup>5</sup> / <sub>16</sub>	2 1/2	3/8	26 <sup>3</sup> / <sub>8</sub>	5/8	90	1 <sup>1</sup> / <sub>16</sub> x 1 <sup>3</sup> / <sub>16</sub>
24	3 1/2	24TE7-*	16 <sup>1</sup> / <sub>2</sub>	7 <sup>3</sup> / <sub>8</sub>	4 <sup>3</sup> / <sub>4</sub>	5 <sup>5</sup> / <sub>16</sub>	2 1/2	3/8	30 <sup>1</sup> / <sub>4</sub>	5/8	120	1 <sup>1</sup> / <sub>16</sub> x 1 <sup>3</sup> / <sub>16</sub>

## Outside With Feet

Outside trough ends with feet are used to support end bearing, cover and trough. Drilling for bronze bearing or flanged ball bearing is standard.

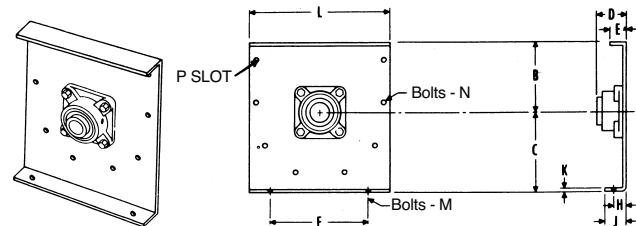

Conveyor Diameter	Shaft Diameter	▲ Part Number	B	C	D			E	F	H	J	K	L	M	N	Weight	P Slot
					Friction Bearing	Ball Bearing	Roller Bearing										
4	1	4TEF2-*	3 <sup>3</sup> / <sub>8</sub>	4 <sup>5</sup> / <sub>8</sub>	2 <sup>5</sup> / <sub>16</sub>	1 <sup>5</sup> / <sub>8</sub>	—	1 <sup>1</sup> / <sub>16</sub>	5 <sup>3</sup> / <sub>4</sub>	1	1 <sup>3</sup> / <sub>8</sub>	1/4	8 <sup>3</sup> / <sub>8</sub>	3/8	3/8	4	7/16 x 9/16
6	1 1/2	6TEF3-*	4 1/2	5 <sup>5</sup> / <sub>8</sub>	3 <sup>3</sup> / <sub>16</sub>	2 <sup>3</sup> / <sub>16</sub>	3 <sup>1</sup> / <sub>16</sub>	1 1/2	8 <sup>3</sup> / <sub>8</sub>	1	1 <sup>1</sup> / <sub>4</sub>	1/4	10 <sup>3</sup> / <sub>8</sub>	3/8	3/8	7	7/16 x 9/16
9	1 1/2	9TEF3-*	6 <sup>3</sup> / <sub>8</sub>	7 <sup>3</sup> / <sub>8</sub>	3 <sup>3</sup> / <sub>16</sub>	2 <sup>3</sup> / <sub>16</sub>	3 <sup>1</sup> / <sub>16</sub>	1 <sup>5</sup> / <sub>8</sub>	9 <sup>3</sup> / <sub>8</sub>	1 1/2	2 <sup>3</sup> / <sub>8</sub>	1/4	13 <sup>3</sup> / <sub>8</sub>	1/2	3/8	12	7/16 x 9/16
	2	9TEF4-*	6 <sup>3</sup> / <sub>8</sub>	7 <sup>3</sup> / <sub>8</sub>	4 <sup>3</sup> / <sub>16</sub>	2 <sup>1</sup> / <sub>2</sub>	3 <sup>3</sup> / <sub>16</sub>	1 <sup>5</sup> / <sub>8</sub>	9 <sup>3</sup> / <sub>8</sub>	1 1/2	2 <sup>3</sup> / <sub>8</sub>	1/4	13 <sup>3</sup> / <sub>8</sub>	1/2	3/8	12	7/16 x 9/16
10	1 1/2	10TEF3-*	6 <sup>3</sup> / <sub>8</sub>	8 <sup>3</sup> / <sub>8</sub>	3 <sup>3</sup> / <sub>16</sub>	2 <sup>3</sup> / <sub>16</sub>	3 <sup>1</sup> / <sub>16</sub>	1 <sup>3</sup> / <sub>4</sub>	9 <sup>3</sup> / <sub>2</sub>	1 <sup>3</sup> / <sub>4</sub>	2 <sup>3</sup> / <sub>8</sub>	1/4	14 <sup>3</sup> / <sub>8</sub>	1/2	3/8	14	7/16 x 9/16
	2	10TEF4-*	6 <sup>3</sup> / <sub>8</sub>	8 <sup>3</sup> / <sub>8</sub>	4 <sup>3</sup> / <sub>16</sub>	2 <sup>1</sup> / <sub>2</sub>	3 <sup>3</sup> / <sub>16</sub>	1 <sup>3</sup> / <sub>4</sub>	9 <sup>3</sup> / <sub>2</sub>	1 <sup>3</sup> / <sub>4</sub>	2 <sup>3</sup> / <sub>8</sub>	1/4	14 <sup>3</sup> / <sub>8</sub>	1/2	3/8	14	7/16 x 9/16
12	2	12TEF4-*	7 <sup>3</sup> / <sub>4</sub>	9 <sup>3</sup> / <sub>8</sub>	5	2 <sup>5</sup> / <sub>16</sub>	3 <sup>3</sup> / <sub>8</sub>	2	12 <sup>1</sup> / <sub>4</sub>	1 <sup>5</sup> / <sub>8</sub>	2 <sup>3</sup> / <sub>4</sub>	1/4	17 <sup>1</sup> / <sub>4</sub>	5/8	1/2	23	9/16 x 1 <sup>1</sup> / <sub>16</sub>
	2 1/2	12TEF5-*	7 <sup>3</sup> / <sub>4</sub>	9 <sup>3</sup> / <sub>8</sub>	5 <sup>1</sup> / <sub>2</sub>	2 <sup>5</sup> / <sub>16</sub>	4 <sup>1</sup> / <sub>16</sub>	2	12 <sup>1</sup> / <sub>4</sub>	1 <sup>5</sup> / <sub>8</sub>	2 <sup>3</sup> / <sub>4</sub>	1/4	17 <sup>1</sup> / <sub>4</sub>	5/8	1/2	23	9/16 x 1 <sup>1</sup> / <sub>16</sub>
	3	12TEF6-*	7 <sup>3</sup> / <sub>4</sub>	9 <sup>3</sup> / <sub>8</sub>	5 <sup>3</sup> / <sub>8</sub>	3 <sup>3</sup> / <sub>4</sub>	4 <sup>3</sup> / <sub>16</sub>	2	12 <sup>1</sup> / <sub>4</sub>	1 <sup>5</sup> / <sub>8</sub>	2 <sup>3</sup> / <sub>4</sub>	1/4	17 <sup>1</sup> / <sub>4</sub>	5/8	1/2	23	9/16 x 1 <sup>1</sup> / <sub>16</sub>
14	2 1/2	14TEF5-*	9 <sup>1</sup> / <sub>4</sub>	10 <sup>3</sup> / <sub>8</sub>	5 <sup>1</sup> / <sub>2</sub>	2 <sup>5</sup> / <sub>16</sub>	4 <sup>1</sup> / <sub>16</sub>	2	13 <sup>3</sup> / <sub>2</sub>	1 <sup>5</sup> / <sub>8</sub>	2 <sup>3</sup> / <sub>8</sub>	1/4	19 <sup>1</sup> / <sub>4</sub>	5/8	1/2	38	9/16 x 1 <sup>1</sup> / <sub>16</sub>
	3	14TEF6-*	9 <sup>1</sup> / <sub>4</sub>	10 <sup>3</sup> / <sub>8</sub>	5 <sup>3</sup> / <sub>8</sub>	3 <sup>3</sup> / <sub>4</sub>	4 <sup>3</sup> / <sub>16</sub>	2	13 <sup>3</sup> / <sub>2</sub>	1 <sup>5</sup> / <sub>8</sub>	2 <sup>3</sup> / <sub>8</sub>	1/4	19 <sup>1</sup> / <sub>4</sub>	5/8	1/2	38	9/16 x 1 <sup>1</sup> / <sub>16</sub>
16	3	16TEF6-*	10 <sup>3</sup> / <sub>8</sub>	12	5 <sup>1</sup> / <sub>16</sub>	3 <sup>3</sup> / <sub>16</sub>	5	2 1/2	14 <sup>3</sup> / <sub>8</sub>	2	3 <sup>1</sup> / <sub>4</sub>	5/16	21 <sup>1</sup> / <sub>4</sub>	5/8	3/8	45	1 <sup>1</sup> / <sub>16</sub> x 1 <sup>3</sup> / <sub>16</sub>
18	3	18TEF6-*	12 <sup>3</sup> / <sub>8</sub>	13 <sup>3</sup> / <sub>8</sub>	5 <sup>1</sup> / <sub>16</sub>	3 <sup>3</sup> / <sub>16</sub>	5	2 1/2	16	2	3 <sup>3</sup> / <sub>4</sub>	3/8	24 <sup>1</sup> / <sub>4</sub>	5/8	3/8	67	1 <sup>1</sup> / <sub>16</sub> x 1 <sup>3</sup> / <sub>16</sub>
	3 1/2	18TEF7-*	12 <sup>3</sup> / <sub>8</sub>	13 <sup>3</sup> / <sub>8</sub>	6 <sup>1</sup> / <sub>16</sub>	4 <sup>3</sup> / <sub>16</sub>	5 <sup>3</sup> / <sub>16</sub>	2 1/2	16	2	3 <sup>3</sup> / <sub>4</sub>	3/8	24 <sup>1</sup> / <sub>4</sub>	5/8	3/8	67	1 <sup>1</sup> / <sub>16</sub> x 1 <sup>3</sup> / <sub>16</sub>
20	3	20TEF6-*	13 <sup>1</sup> / <sub>2</sub>	15	5 <sup>1</sup> / <sub>4</sub>	3 <sup>3</sup> / <sub>4</sub>	5 <sup>5</sup> / <sub>16</sub>	2 1/2	19 <sup>1</sup> / <sub>4</sub>	2 <sup>1</sup> / <sub>4</sub>	3 <sup>3</sup> / <sub>4</sub>	3/8	26 <sup>3</sup> / <sub>4</sub>	5/8	3/8	120	1 <sup>1</sup> / <sub>16</sub> x 1 <sup>3</sup> / <sub>16</sub>
	3 1/2	20TEF7-*	13 <sup>1</sup> / <sub>2</sub>	15	7	4 <sup>3</sup> / <sub>4</sub>	5 <sup>5</sup> / <sub>16</sub>	2 1/2	19 <sup>1</sup> / <sub>4</sub>	2 <sup>1</sup> / <sub>4</sub>	3 <sup>3</sup> / <sub>4</sub>	3/8	26 <sup>3</sup> / <sub>4</sub>	5/8	3/8	120	1 <sup>1</sup> / <sub>16</sub> x 1 <sup>3</sup> / <sub>16</sub>
24	3 1/2	24TEF7-*	16 <sup>1</sup> / <sub>2</sub>	18 <sup>3</sup> / <sub>8</sub>	7	4 <sup>3</sup> / <sub>4</sub>	5 <sup>5</sup> / <sub>16</sub>	2 1/2	20	2 <sup>1</sup> / <sub>2</sub>	4 <sup>3</sup> / <sub>4</sub>	3/8	30 <sup>1</sup> / <sub>4</sub>	5/8	3/8	162	1 <sup>1</sup> / <sub>16</sub> x 1 <sup>3</sup> / <sub>16</sub>

▲ Can be furnished with CSP, CSW, or CSFP seals

-\*BB Ball Bearing  
-\*BR Bronze Bearing

-\*RB Roller Bearing  
-\*P Less Bearing

CONVEYORS

# Trough Ends



## Inside

Inside trough ends are used in place of outside type where no trough end flanges are required. Drilling for bronze bearings or flanged ball bearing is standard.

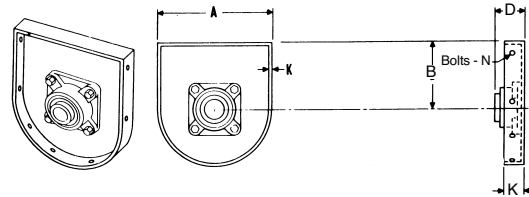

Conveyor Diameter	Shaft Diameter	▲ Part Number	A	B	D			E	K	N	Weight
					Friction Bearing	Ball Bearing	Roller Bearing				
4	1	4TEI2-*	5	3 <sup>3</sup> / <sub>8</sub>	2 <sup>3</sup> / <sub>16</sub>	1 <sup>1</sup> / <sub>8</sub>	—	2	1/4	1/4	3
6	1 1/2	6TEI3-*	7	4 1/2	3 <sup>3</sup> / <sub>16</sub>	2 <sup>3</sup> / <sub>16</sub>	3 <sup>1</sup> / <sub>16</sub>	2	1/4	5/16	5
9	1 1/2	9TEI3-*	10	6 <sup>1</sup> / <sub>8</sub>	3 <sup>3</sup> / <sub>4</sub>	2 <sup>3</sup> / <sub>16</sub>	3 <sup>1</sup> / <sub>16</sub>	2	1/4	3/8	9
	2	9TEI4-*	10	6 <sup>1</sup> / <sub>8</sub>	4 <sup>1</sup> / <sub>4</sub>	2 <sup>1</sup> / <sub>2</sub>	3 <sup>3</sup> / <sub>16</sub>	2	1/4	3/8	9
10	1 1/2	10TEI3-*	11	6 <sup>1</sup> / <sub>8</sub>	3 <sup>3</sup> / <sub>4</sub>	2 <sup>3</sup> / <sub>16</sub>	3 <sup>1</sup> / <sub>16</sub>	2	1/4	3/8	11
	2	10TEI4-*	11	6 <sup>1</sup> / <sub>8</sub>	4 <sup>1</sup> / <sub>4</sub>	2 <sup>1</sup> / <sub>2</sub>	3 <sup>3</sup> / <sub>16</sub>	2	1/4	3/8	11
12	2	12TEI4-*	13	7 <sup>1</sup> / <sub>4</sub>	4 <sup>1</sup> / <sub>4</sub>	2 <sup>3</sup> / <sub>16</sub>	3 <sup>3</sup> / <sub>8</sub>	2	1/4	1/2	19
	2 1/16	12TEI5-*	13	7 <sup>1</sup> / <sub>4</sub>	5 <sup>1</sup> / <sub>4</sub>	2 <sup>3</sup> / <sub>16</sub>	4 <sup>1</sup> / <sub>16</sub>	2	1/4	1/2	19
	3	12TEI6-*	13	7 <sup>1</sup> / <sub>4</sub>	6 <sup>1</sup> / <sub>4</sub>	3 <sup>3</sup> / <sub>4</sub>	4 <sup>1</sup> / <sub>16</sub>	2	1/4	1/2	19
14	2 1/16	14TEI5-*	15	9 <sup>1</sup> / <sub>4</sub>	5 <sup>3</sup> / <sub>16</sub>	2 <sup>3</sup> / <sub>16</sub>	4 <sup>7</sup> / <sub>16</sub>	2	1/4	1/2	34
	3	14TEI6-*	15	9 <sup>1</sup> / <sub>4</sub>	6 <sup>3</sup> / <sub>16</sub>	3 <sup>3</sup> / <sub>4</sub>	4 <sup>1</sup> / <sub>16</sub>	2	1/4	1/2	34
16	3	16TEI6-*	17	10 <sup>3</sup> / <sub>8</sub>	6 <sup>3</sup> / <sub>16</sub>	3 <sup>3</sup> / <sub>16</sub>	5	2	5/16	3/8	40
	3 3/16	18TEI6-*	19	12 <sup>1</sup> / <sub>2</sub>	6 <sup>3</sup> / <sub>8</sub>	3 <sup>3</sup> / <sub>16</sub>	5	2	3/8	3/8	58
18	3	18TEI6-*	19	12 <sup>1</sup> / <sub>2</sub>	7 <sup>3</sup> / <sub>8</sub>	4 <sup>3</sup> / <sub>16</sub>	5 <sup>3</sup> / <sub>16</sub>	2	3/8	3/8	58
	3 3/16	18TEI7-*	19	12 <sup>1</sup> / <sub>2</sub>	7 <sup>3</sup> / <sub>8</sub>	4 <sup>3</sup> / <sub>16</sub>	5 <sup>3</sup> / <sub>16</sub>	2	3/8	3/8	58
20	3	20TEI6-*	21	13 <sup>1</sup> / <sub>2</sub>	6 <sup>3</sup> / <sub>8</sub>	3 <sup>3</sup> / <sub>8</sub>	5 <sup>3</sup> / <sub>16</sub>	2	3/8	3/8	83
	3 1/16	20TEI7-*	21	13 <sup>1</sup> / <sub>2</sub>	7 <sup>3</sup> / <sub>8</sub>	4 <sup>3</sup> / <sub>8</sub>	5 <sup>3</sup> / <sub>8</sub>	2	3/8	3/8	83
24	3 1/16	24TEI7-*	25	16 <sup>1</sup> / <sub>2</sub>	7 <sup>3</sup> / <sub>8</sub>	4 <sup>3</sup> / <sub>8</sub>	5 <sup>3</sup> / <sub>8</sub>	2	3/8	3/8	116

## Inside Rectangular

Rectangular trough ends are used inside of rectangular trough. Drilling for bronze bearing or flanged ball bearing is standard.

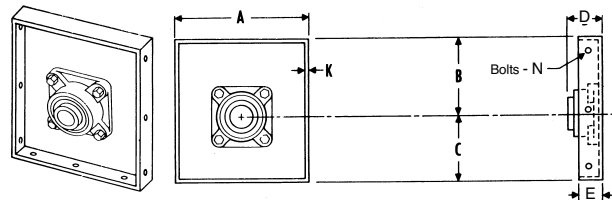

Conveyor Diameter	Shaft Diameter	▲ Part Number	A	B	C	D			E	K	N	Weight
						Friction Bearing	Ball Bearing	Roller Bearing				
4	1	4TER2-*	5	3 <sup>3</sup> / <sub>8</sub>	2 1/2	2 <sup>3</sup> / <sub>16</sub>	1 <sup>1</sup> / <sub>8</sub>	—	2	1/4	1/4	4
6	1 1/2	6TER3-*	7	4 1/2	3 1/2	3 <sup>3</sup> / <sub>16</sub>	2 <sup>3</sup> / <sub>16</sub>	3 <sup>1</sup> / <sub>16</sub>	2	1/4	5/16	6
9	1 1/2	9TER3-*	10	6 <sup>1</sup> / <sub>8</sub>	5	3 <sup>3</sup> / <sub>4</sub>	2 <sup>3</sup> / <sub>16</sub>	3 <sup>1</sup> / <sub>16</sub>	2	1/4	3/8	9
	2	9TER4-*	10	6 <sup>1</sup> / <sub>8</sub>	5	4 <sup>1</sup> / <sub>4</sub>	2 <sup>1</sup> / <sub>2</sub>	3 <sup>3</sup> / <sub>16</sub>	2	1/4	3/8	9
10	1 1/2	10TER3-*	11	6 <sup>1</sup> / <sub>8</sub>	5 1/2	3 <sup>3</sup> / <sub>4</sub>	2 <sup>3</sup> / <sub>16</sub>	3 <sup>1</sup> / <sub>16</sub>	2	1/4	3/8	12
	2	10TER4-*	11	6 <sup>1</sup> / <sub>8</sub>	5 1/2	4 <sup>1</sup> / <sub>4</sub>	2 <sup>1</sup> / <sub>2</sub>	3 <sup>3</sup> / <sub>16</sub>	2	1/4	3/8	12
12	2	12TER4-*	13	7 <sup>1</sup> / <sub>4</sub>	6 1/2	4 <sup>1</sup> / <sub>4</sub>	2 <sup>3</sup> / <sub>16</sub>	3 <sup>3</sup> / <sub>8</sub>	2	1/4	1/2	21
	2 1/16	12TER5-*	13	7 <sup>1</sup> / <sub>4</sub>	6 1/2	5 <sup>1</sup> / <sub>4</sub>	2 <sup>3</sup> / <sub>16</sub>	4 <sup>1</sup> / <sub>16</sub>	2	1/4	1/2	21
	3	12TER6-*	13	7 <sup>1</sup> / <sub>4</sub>	6 1/2	6 <sup>1</sup> / <sub>4</sub>	3 <sup>3</sup> / <sub>4</sub>	4 <sup>1</sup> / <sub>16</sub>	2	1/4	1/2	21
14	2 1/16	14TER5-*	15	9 <sup>1</sup> / <sub>4</sub>	7 1/2	5 <sup>3</sup> / <sub>16</sub>	2 <sup>3</sup> / <sub>16</sub>	4 <sup>7</sup> / <sub>16</sub>	2	1/4	1/2	35
	3	14TER6-*	15	9 <sup>1</sup> / <sub>4</sub>	7 1/2	6 <sup>3</sup> / <sub>16</sub>	3 <sup>3</sup> / <sub>4</sub>	4 <sup>1</sup> / <sub>16</sub>	2	1/4	1/2	35
16	3	16TER6-*	17	10 <sup>3</sup> / <sub>8</sub>	8 1/2	6 <sup>3</sup> / <sub>16</sub>	3 <sup>3</sup> / <sub>16</sub>	5	2	5/16	3/8	41
	3 3/16	18TER6-*	19	12 <sup>1</sup> / <sub>2</sub>	9 1/2	6 <sup>3</sup> / <sub>8</sub>	3 <sup>3</sup> / <sub>16</sub>	5	2	3/8	3/8	60
18	3	18TER6-*	19	12 <sup>1</sup> / <sub>2</sub>	9 1/2	7 <sup>3</sup> / <sub>8</sub>	4 <sup>3</sup> / <sub>16</sub>	5 <sup>3</sup> / <sub>16</sub>	2	3/8	3/8	60
	3 3/16	18TER7-*	19	12 <sup>1</sup> / <sub>2</sub>	9 1/2	7 <sup>3</sup> / <sub>8</sub>	4 <sup>3</sup> / <sub>16</sub>	5 <sup>3</sup> / <sub>16</sub>	2	3/8	3/8	60
20	3	20TER6-*	21	13 <sup>1</sup> / <sub>2</sub>	10 1/2	6 <sup>3</sup> / <sub>8</sub>	3 <sup>3</sup> / <sub>8</sub>	5 <sup>3</sup> / <sub>16</sub>	2	3/8	3/8	88
	3 1/16	20TER7-*	21	13 <sup>1</sup> / <sub>2</sub>	10 1/2	7 <sup>3</sup> / <sub>8</sub>	4 <sup>3</sup> / <sub>8</sub>	5 <sup>3</sup> / <sub>8</sub>	2	3/8	3/8	88
24	3 1/16	24TER7-*	25	16 <sup>1</sup> / <sub>2</sub>	12 1/2	7 <sup>3</sup> / <sub>8</sub>	4 <sup>3</sup> / <sub>8</sub>	5 <sup>3</sup> / <sub>8</sub>	2	3/8	3/8	125

▲ Can be furnished with CSP, CSW, or CSS seals

-\*BB Ball Bearing  
-\*BP Bronze Bearing

-\*RB Roller Bearing  
-\*P Less Bearing



# Trough Ends

## Single Bearing

Single bearing pedestal type trough ends are constructed with base for mounting pillow block bearings and shaft seal or packing gland.

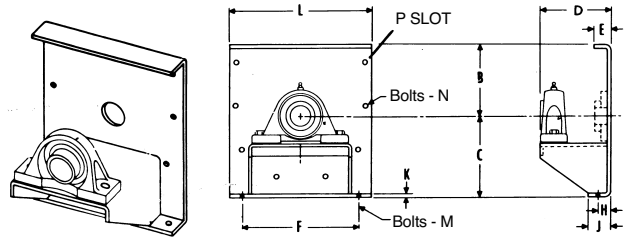

Conveyor Diameter	Shaft Diameter	Part Number	B	C	D	E	F	H	J	K	L	M	N	P Slot	Weight
6	1½	6TEO3	<b>Consult Factory</b>												
9	1½ 2	9TEO3 9TEO4													
10	1½ 2	10TEO3 10TEO4													
12	2 2⅞ 3	12TEO4 12TEO5 12TEO6													
14	2⅞ 3	14TEO5 14TEO6													
16	3	16TEO6													
18	3 3⅞	18TEO6 18TEO7													
20	3 3⅞	20TEO6 20TEO7													
24	3⅞	24TEO7													

## Double Bearing

Double bearing pedestal type trough ends are for use with pillow block bearing in conjunction with a flanged bearing providing extra shaft support.

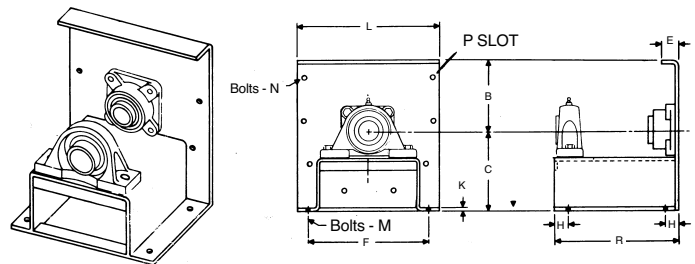

Conveyor Diameter	Shaft Diameter	Part Number	B	C	E	F	H	K	L	M	N	R	P Slot	Weight
6	1½	6TEOD3	<b>Consult Factory</b>											
9	1½ 2	9TEOD3 9TEOD4												
10	1½ 2	10TEOD3 10TEOD4												
12	2 2⅞ 3	12TEOD4 12TEOD5 12TEOD6												
14	2⅞ 3	14TEOD5 14TEOD6												
16	3	16TEOD6												
18	3 3⅞	18TEOD6 18TEOD7												
20	3 3⅞	20TEOD6 20TEOD7												
24	3⅞	24TEOD7												

CONVEYORS

# Trough Ends

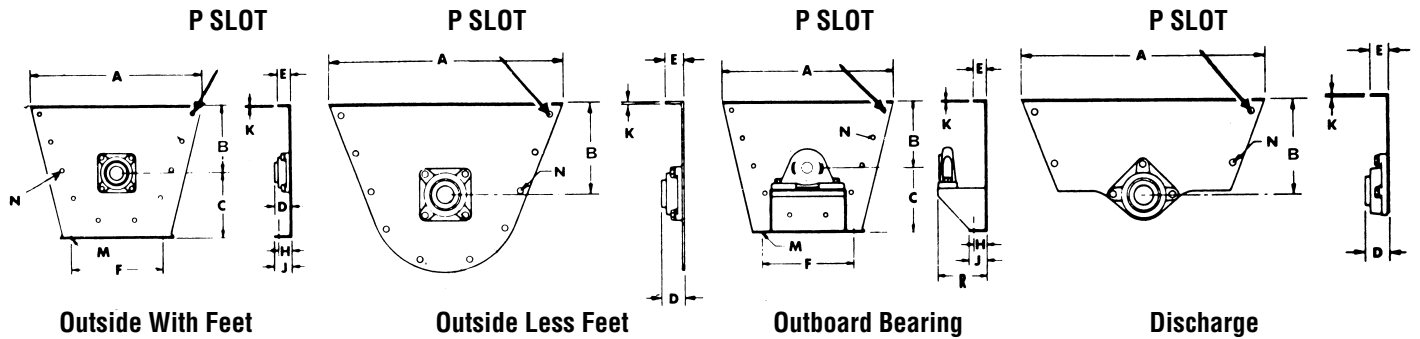

Application: same as standard trough ends except for flared trough.

Conveyor Diameter	Shaft Diameter	A	B	C	D			E	F	H	J	K	M	N	R	P Slot
					Friction Bearing	Ball Bearing	Roller Bearing									
6	1½	16⅞	7	5⅝	3⅜	2⅜	3¼	1½	8⅞	1	1¼	¼	⅜	⅜	Consult Factory	7/16 x 9/16
9	1½	21¼	9	7⅞	3¼	2⅜	3¼	1⅞	9⅞	1½	2⅞	¼	½	⅜		7/16 x 9/16
	2	21¼	9	7⅞	4¼	2½	3⅞	1⅞	9⅞	1½	2⅞	¼	½	⅜		7/16 x 9/16
12	2	26⅞	10	9⅞	4¼	2⅜	3⅞	2	12¼	1⅞	2¼	¼	⅝	½		9/16 x 11/16
	2⅜	26⅞	10	9⅞	5¼	2⅜	4½	2	12¼	1⅞	2¼	¼	⅝	½		9/16 x 11/16
14	2⅜	28⅞	11	10⅞	5⅜	2⅜	4½	2	13½	1⅞	2⅞	¼	⅝	½		9/16 x 11/16
	3	28⅞	11	10⅞	6⅜	3⅞	5	2	13½	1⅞	2⅞	⅜	⅝	½		9/16 x 11/16
16	3	32½	11½	12	6⅜	3⅜	5	2½	14⅞	2	3¼	⅝	⅝	⅝		11/16 x 13/16
	3⅜	36½	12⅞	13⅞	7⅞	4⅜	5⅞	2½	16	2	3¼	⅝	⅝	⅝	11/16 x 13/16	
20	3	39½	13½	15	6⅞	3⅞	5	2½	19¼	2¼	3¼	⅝	¾	⅝	11/16 x 13/16	
	3⅜	39½	13½	15	7⅞	4⅞	5⅞	2½	19¼	2¼	3¼	⅝	¾	⅝	11/16 x 13/16	
24	3⅜	45½	16½	18⅞	7⅞	4⅞	5⅞	2½	20	2½	4¼	⅝	¾	⅝	11/16 x 13/16	

CONVEYORS

Conveyor Diameter	Shaft Diameter	Part Number							
		Outside With Feet	Weight	Outside Less Feet	Weight	Outboard Bearing	Weight	Discharge	Weight
6	1½	6FTEF3-*	15	6FTE3-*	13	6FTEO3-*	22	6FTDO3-**	11
9	1½	9FTEF3-*	22	9FTE3-*	19	9FTEO3-*	31	9FTDO3-**	15
	2	9FTEF4-*	27	9FTE4-*	24	9FTEO4-*	36	9FTDO4-**	20
12	2	12FTEF4-*	43	12FTE4-*	36	12FTEO4-*	63	12FTDO4-**	28
	2⅜	12FTEF5-*	44	12FTE5-*	37	12FTEO5-*	64	12FTDO5-**	29
	3	12FTEF6-*	56	12FTE6-*	49	12FTEO6-*	76	12FTDO6-**	41
14	2⅜	14FTEF5-*	52	14FTE5-*	43	14FTEO5-*	75	14FTDO5-**	33
	3	14FTEF6-*	64	14FTE6-*	55	14FTEO6-*	87	14FTDO6-**	45
16	3	16FTEF6-*	85	16FTE6-*	72	16FTEO6-*	125	16FTDO6-**	56
	18	3	18FTEF6-*	98	18FTE6-*	83	18FTEO6-*	138	18FTDO6-**
3⅜		18FTEF7-*	104	18FTE7-*	89	18FTEO7-*	144	18FTDO7-**	69
20	3	20FTEF6-*	133	20FTE6-*	103	20FTEO6-*	196	20FTDO6-**	75
	3⅜	20FTEF7-*	139	20FTE7-*	109	20FTEO7-*	202	20FTDO7-**	81
24	3⅜	24FTEF7-*	179	24FTE7-*	132	24FTEO7-*	250	24FTDO7-**	96

- \*BB Ball Bearing
- \*BR Bronze Bearing
- \*RB Roller Bearing
- \*P Less Bearing

For Bolt Pattern see Page H-42



# Trough Ends

## Outside Discharge

Outside discharge trough ends are used to support end bearing and will allow material to discharge or overflow through the end of the trough. Drilling for three bolt bronze or flanged ball bearing is standard.

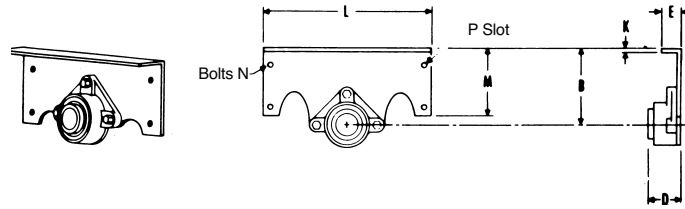

Conveyor Diameter	Shaft Diameter	Part Number	B	D			E	K	L	M	N	P Slot	Weight
				Friction Bearing	Ball Bearing	Roller Bearing							
4	1	4TDO2-*	3 <sup>3</sup> / <sub>8</sub>	2 <sup>1</sup> / <sub>16</sub>	1 <sup>5</sup> / <sub>8</sub>		2	1/4	8	3 <sup>3</sup> / <sub>8</sub>	3/8	7/16 x 9/16	2
6	1 1/2	6TDO3-*	4 1/2	3 <sup>3</sup> / <sub>16</sub>	2 <sup>1</sup> / <sub>16</sub>	3 <sup>1</sup> / <sub>16</sub>	2	1/4	9 3/4	4 1/2	3/8	7/16 x 9/16	3
9	1 1/2 2	9TDO3- 9TDO4-*	6 <sup>1</sup> / <sub>8</sub> 6 <sup>1</sup> / <sub>8</sub>	3 <sup>1</sup> / <sub>4</sub> 4 <sup>1</sup> / <sub>4</sub>	2 <sup>1</sup> / <sub>16</sub> 2 <sup>1</sup> / <sub>2</sub>	3 <sup>1</sup> / <sub>16</sub> 3 <sup>3</sup> / <sub>16</sub>	2 2	1/4 1/4	13 <sup>3</sup> / <sub>4</sub> 13 <sup>3</sup> / <sub>4</sub>	6 <sup>1</sup> / <sub>8</sub> 6 <sup>1</sup> / <sub>8</sub>	3/8 3/8	7/16 x 9/16 7/16 x 9/16	5 5
10	1 1/2 2	10TDO3- 10TDO4-*	6 <sup>3</sup> / <sub>8</sub> 6 <sup>3</sup> / <sub>8</sub>	3 <sup>1</sup> / <sub>4</sub> 4 <sup>1</sup> / <sub>4</sub>	2 <sup>1</sup> / <sub>16</sub> 2 <sup>1</sup> / <sub>2</sub>	3 <sup>1</sup> / <sub>16</sub> 3 <sup>3</sup> / <sub>16</sub>	2 2	1/4 1/4	14 <sup>3</sup> / <sub>4</sub> 14 <sup>3</sup> / <sub>4</sub>	6 <sup>3</sup> / <sub>8</sub> 6 <sup>3</sup> / <sub>8</sub>	3/8 3/8	7/16 x 9/16 7/16 x 9/16	6 6
12	2 2 1/16 3	12TDO4- 12TDO5- 12TDO6-*	7 <sup>3</sup> / <sub>4</sub> 7 <sup>3</sup> / <sub>4</sub> 7 <sup>3</sup> / <sub>4</sub>	4 <sup>1</sup> / <sub>4</sub> 5 <sup>1</sup> / <sub>4</sub> 6 <sup>1</sup> / <sub>4</sub>	2 <sup>1</sup> / <sub>16</sub> 2 <sup>1</sup> / <sub>16</sub> 3 <sup>1</sup> / <sub>4</sub>	3 <sup>3</sup> / <sub>8</sub> 4 <sup>1</sup> / <sub>16</sub> 4 <sup>1</sup> / <sub>16</sub>	2 2 2	1/4 1/4 1/4	17 1/2 17 1/2 17 1/2	7 <sup>3</sup> / <sub>4</sub> 7 <sup>3</sup> / <sub>4</sub> 7 <sup>3</sup> / <sub>4</sub>	1/2 1/2 1/2	9/16 x 3/4 9/16 x 3/4 9/16 x 3/4	12 12 12
14	2 1/16 3	14TDO5- 14TDO6-*	9 <sup>1</sup> / <sub>4</sub> 9 <sup>1</sup> / <sub>4</sub>	5 <sup>1</sup> / <sub>16</sub> 6 <sup>1</sup> / <sub>16</sub>	2 <sup>1</sup> / <sub>16</sub> 3 <sup>1</sup> / <sub>4</sub>	4 <sup>1</sup> / <sub>16</sub> 4 <sup>1</sup> / <sub>16</sub>	2 2	1/4 1/4	19 <sup>1</sup> / <sub>4</sub> 19 <sup>1</sup> / <sub>4</sub>	9 <sup>1</sup> / <sub>4</sub> 9 <sup>1</sup> / <sub>4</sub>	1/2 1/2	9/16 x 3/4 9/16 x 3/4	17 17
16	3	16TDO6-*	10 <sup>3</sup> / <sub>8</sub>	6 <sup>1</sup> / <sub>16</sub>	3 <sup>1</sup> / <sub>16</sub>	5	2	5/16	21 1/8	10 <sup>3</sup> / <sub>8</sub>	5/8	1 1/16 x 7/8	26
18	3 3 1/16	18TDO6- 18TDO7-*	12 <sup>1</sup> / <sub>8</sub> 12 <sup>1</sup> / <sub>8</sub>	6 <sup>3</sup> / <sub>8</sub> 7 <sup>3</sup> / <sub>8</sub>	3 <sup>1</sup> / <sub>16</sub> 4 <sup>1</sup> / <sub>16</sub>	5 5 <sup>1</sup> / <sub>16</sub>	2 2	3/8 3/8	23 1/2 23 1/2	12 <sup>1</sup> / <sub>8</sub> 12 <sup>1</sup> / <sub>8</sub>	5/8 5/8	1 1/16 x 7/8 1 1/16 x 7/8	33 33
20	3 3 1/16	20TDO6- 20TDO7-*	13 1/2 13 1/2	6 <sup>3</sup> / <sub>8</sub> 7 <sup>3</sup> / <sub>8</sub>	3 <sup>1</sup> / <sub>8</sub> 4 <sup>3</sup> / <sub>8</sub>	5 <sup>1</sup> / <sub>16</sub> 5 <sup>3</sup> / <sub>8</sub>	2 2	3/8 3/8	26 <sup>3</sup> / <sub>4</sub> 26 <sup>3</sup> / <sub>4</sub>	13 1/2 13 1/2	5/8 5/8	1 1/16 x 7/8 1 1/16 x 7/8	55 55
24	3 1/16	24TDO7-*	16 1/2	7 <sup>3</sup> / <sub>8</sub>	4 <sup>3</sup> / <sub>8</sub>	5 <sup>3</sup> / <sub>8</sub>	2	3/8	30 1/2	16 1/2	5/8	1 1/16 x 7/8	81

## Inside Discharge

Inside discharge trough ends are used to support end bearing and will allow material to discharge or overflow through the end of the trough. This trough end is used inside the trough where no trough end flanges are required. Drilling for three bolt bronze or flanged ball bearing is standard.

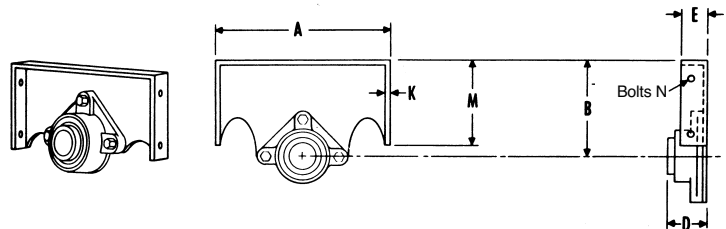

Conveyor Diameter	Shaft Diameter	Part Number	A	B	D			E	K	M	N	Weight
					Friction Bearing	Ball Bearing	Roller Bearing					
4	1	4TDI2-*	5	3 <sup>3</sup> / <sub>8</sub>	2 <sup>1</sup> / <sub>16</sub>	1 <sup>5</sup> / <sub>8</sub>	2	1/4	3 <sup>3</sup> / <sub>8</sub>	3/8	2	
6	1 1/2	6TDI3-*	7	4 1/2	3 <sup>3</sup> / <sub>16</sub>	2 <sup>1</sup> / <sub>16</sub>	3 <sup>1</sup> / <sub>16</sub>	2	1/4	4 1/2	3/8	3
9	1 1/2 2	9TDI3- 9TDI4-*	10 10	6 <sup>1</sup> / <sub>8</sub> 6 <sup>1</sup> / <sub>8</sub>	3 <sup>1</sup> / <sub>4</sub> 4 <sup>1</sup> / <sub>4</sub>	2 <sup>1</sup> / <sub>16</sub> 2 <sup>1</sup> / <sub>2</sub>	3 <sup>1</sup> / <sub>16</sub> 3 <sup>3</sup> / <sub>16</sub>	2 2	1/4 1/4	6 <sup>1</sup> / <sub>8</sub> 6 <sup>1</sup> / <sub>8</sub>	3/8 3/8	5 5
10	1 1/2 2	10TDI3- 10TDI4-*	11 11	6 <sup>3</sup> / <sub>8</sub> 6 <sup>3</sup> / <sub>8</sub>	3 <sup>1</sup> / <sub>4</sub> 4 <sup>1</sup> / <sub>4</sub>	2 <sup>1</sup> / <sub>16</sub> 2 <sup>1</sup> / <sub>2</sub>	3 <sup>1</sup> / <sub>16</sub> 3 <sup>3</sup> / <sub>16</sub>	2 2	1/4 1/4	6 <sup>3</sup> / <sub>8</sub> 6 <sup>3</sup> / <sub>8</sub>	3/8 3/8	6 6
12	2 2 1/16 3	12TDI4- 12TDI5- 12TDI6-*	13 13 13	7 <sup>3</sup> / <sub>4</sub> 7 <sup>3</sup> / <sub>4</sub> 7 <sup>3</sup> / <sub>4</sub>	4 <sup>1</sup> / <sub>4</sub> 5 <sup>1</sup> / <sub>4</sub> 6 <sup>1</sup> / <sub>4</sub>	2 <sup>1</sup> / <sub>16</sub> 2 <sup>1</sup> / <sub>16</sub> 3 <sup>1</sup> / <sub>4</sub>	3 <sup>3</sup> / <sub>8</sub> 4 <sup>1</sup> / <sub>16</sub> 4 <sup>1</sup> / <sub>16</sub>	2 2 2	1/4 1/4 1/4	7 <sup>3</sup> / <sub>4</sub> 7 <sup>3</sup> / <sub>4</sub> 7 <sup>3</sup> / <sub>4</sub>	1/2 1/2 1/2	12 12 12
14	2 1/16 3	14TDI5- 14TDI6-*	15 15	9 <sup>1</sup> / <sub>4</sub> 9 <sup>1</sup> / <sub>4</sub>	5 <sup>1</sup> / <sub>16</sub> 6 <sup>1</sup> / <sub>16</sub>	2 <sup>1</sup> / <sub>16</sub> 3 <sup>1</sup> / <sub>4</sub>	4 <sup>1</sup> / <sub>16</sub> 4 <sup>1</sup> / <sub>16</sub>	2 2	1/4 1/4	9 <sup>1</sup> / <sub>4</sub> 0.9 1/4	5/8 5/8	16 16
16	3	16TDI6-*	17	10 <sup>3</sup> / <sub>8</sub>	6 <sup>1</sup> / <sub>16</sub>	3 <sup>1</sup> / <sub>16</sub>	5	2	5/16	10 <sup>3</sup> / <sub>8</sub>	5/8	25
18	3 3 1/16	18TDI6- 18TDI7-*	19 19	12 <sup>1</sup> / <sub>8</sub> 12 <sup>1</sup> / <sub>8</sub>	6 <sup>3</sup> / <sub>8</sub> 7 <sup>3</sup> / <sub>8</sub>	3 <sup>1</sup> / <sub>16</sub> 4 <sup>1</sup> / <sub>16</sub>	5 5 <sup>1</sup> / <sub>16</sub>	2 2	3/8 3/8	12 <sup>1</sup> / <sub>8</sub> 12 <sup>1</sup> / <sub>8</sub>	5/8 5/8	32 32
20	3 3 1/16	20TDI6- 20TDI7-*	21 21	13 1/2 13 1/2	6 <sup>3</sup> / <sub>8</sub> 7 <sup>3</sup> / <sub>8</sub>	3 <sup>1</sup> / <sub>8</sub> 4 <sup>3</sup> / <sub>8</sub>	5 <sup>1</sup> / <sub>16</sub> 5 <sup>3</sup> / <sub>8</sub>	2 2	3/8 3/8	13 1/2 13 1/2	5/8 5/8	50 50
24	3 1/16	24TDI7-*	25	16 1/2	7 <sup>3</sup> / <sub>8</sub>	4 <sup>3</sup> / <sub>8</sub>	5 <sup>3</sup> / <sub>8</sub>	2	3/8	16 1/2	5/8	76

-\*BB Ball Bearing  
-\*BR Bronze Bearing  
\_\*RB Roller Bearing  
-\*P Less Bearing

CONVEYORS

# Trough Ends



## Outside

Outside tubular trough ends less feet are used to support end bearings on tubular trough where no foot or support is required. Drilling for bronze or flanged ball bearing is standard.

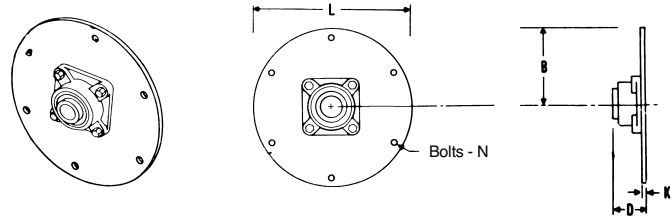

Conveyor Diameter	Shaft Diameter	Part Number	B	D			K	L	N	Weight
				Friction Bearing	Ball Bearing	Roller Bearing				
4	1	4CHTE2-*	4	2 <sup>3</sup> / <sub>16</sub>	1 <sup>5</sup> / <sub>16</sub>		1/4	8	3/8	2
6	1 1/2	6CHTE3-*	5 <sup>1</sup> / <sub>16</sub>	3 <sup>3</sup> / <sub>16</sub>	2 <sup>3</sup> / <sub>16</sub>	3 <sup>1</sup> / <sub>16</sub>	1/4	10 <sup>1</sup> / <sub>16</sub>	3/8	3
9	1 1/2	9CHTE3-*	6 <sup>5</sup> / <sub>16</sub>	3 <sup>3</sup> / <sub>4</sub>	2 <sup>3</sup> / <sub>16</sub>	3 <sup>1</sup> / <sub>16</sub>	1/4	13 <sup>3</sup> / <sub>4</sub>	3/8	6
	2	9CHTE4-*	6 <sup>5</sup> / <sub>16</sub>	4 <sup>1</sup> / <sub>4</sub>	2 <sup>1</sup> / <sub>2</sub>	3 <sup>3</sup> / <sub>16</sub>	1/4	13 <sup>3</sup> / <sub>4</sub>	3/8	6
10	1 1/2	10CHTE3-*	7 <sup>3</sup> / <sub>16</sub>	3 <sup>1</sup> / <sub>4</sub>	2 <sup>3</sup> / <sub>16</sub>	3 <sup>1</sup> / <sub>16</sub>	1/4	14 <sup>3</sup> / <sub>4</sub>	3/8	7
	2	10CHTE4-*	7 <sup>3</sup> / <sub>16</sub>	4 <sup>1</sup> / <sub>4</sub>	2 <sup>1</sup> / <sub>2</sub>	3 <sup>3</sup> / <sub>16</sub>	1/4	14 <sup>3</sup> / <sub>4</sub>	3/8	7
12	2	12CHTE4-*	8 <sup>1</sup> / <sub>16</sub>	4 <sup>1</sup> / <sub>4</sub>	2 <sup>3</sup> / <sub>16</sub>	3 <sup>3</sup> / <sub>8</sub>	1/4	16 <sup>1</sup> / <sub>4</sub>	1/2	13
	2 1/16	12CHTE5-*	8 <sup>1</sup> / <sub>16</sub>	5 <sup>1</sup> / <sub>4</sub>	2 <sup>1</sup> / <sub>16</sub>	4 <sup>1</sup> / <sub>16</sub>	1/4	16 <sup>1</sup> / <sub>4</sub>	1/2	13
	3	12CHTE6-*	8 <sup>1</sup> / <sub>16</sub>	6 <sup>1</sup> / <sub>4</sub>	3 <sup>3</sup> / <sub>4</sub>	4 <sup>1</sup> / <sub>16</sub>	1/4	16 <sup>1</sup> / <sub>4</sub>	1/2	13
14	2 1/16	14CHTE5-*	9 <sup>1</sup> / <sub>16</sub>	5 <sup>1</sup> / <sub>16</sub>	2 <sup>1</sup> / <sub>16</sub>	4 <sup>1</sup> / <sub>16</sub>	1/4	18 <sup>1</sup> / <sub>4</sub>	1/2	19
	3	14CHTE6-*	9 <sup>1</sup> / <sub>16</sub>	6 <sup>1</sup> / <sub>16</sub>	3 <sup>3</sup> / <sub>4</sub>	4 <sup>1</sup> / <sub>16</sub>	1/4	18 <sup>1</sup> / <sub>4</sub>	1/2	19
16	3	16CHTE6-*	10 <sup>1</sup> / <sub>16</sub>	6 <sup>1</sup> / <sub>16</sub>	3 <sup>1</sup> / <sub>16</sub>	5	5/16	21 <sup>1</sup> / <sub>4</sub>	5/8	29
18	3	18CHTE6-*	12 <sup>1</sup> / <sub>16</sub>	6 <sup>1</sup> / <sub>16</sub>	3 <sup>1</sup> / <sub>16</sub>	5	3/8	24 <sup>1</sup> / <sub>4</sub>	5/8	39
	3 1/16	18CHTE7-*	12 <sup>1</sup> / <sub>16</sub>	7 <sup>1</sup> / <sub>16</sub>	4 <sup>1</sup> / <sub>16</sub>	5 <sup>1</sup> / <sub>16</sub>	3/8	24 <sup>1</sup> / <sub>4</sub>	5/8	39
20	3	20CHTE6-*	13 <sup>1</sup> / <sub>16</sub>	6 <sup>1</sup> / <sub>16</sub>	3 <sup>3</sup> / <sub>8</sub>	5 <sup>1</sup> / <sub>16</sub>	3/8	26 <sup>1</sup> / <sub>4</sub>	5/8	63
	3 1/16	20CHTE7-*	13 <sup>1</sup> / <sub>16</sub>	7 <sup>1</sup> / <sub>16</sub>	4 <sup>3</sup> / <sub>8</sub>	5 <sup>1</sup> / <sub>16</sub>	3/8	26 <sup>1</sup> / <sub>4</sub>	5/8	63
24	3 1/16	24CHTE7-*	15 <sup>1</sup> / <sub>16</sub>	7 <sup>1</sup> / <sub>16</sub>	4 <sup>3</sup> / <sub>8</sub>	5 <sup>1</sup> / <sub>16</sub>	3/8	30 <sup>1</sup> / <sub>4</sub>	5/8	87

## Outside with Feet

Outside tubular trough ends with feet are used to support end bearing where trough support is required. Drilling for bronze bearing or flanged ball bearing is standard.

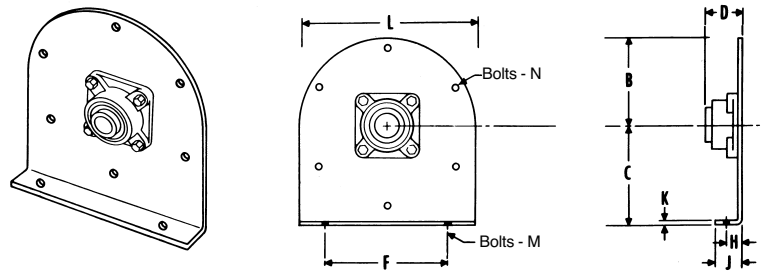

Conveyor Diameter	Shaft Diameter	Part Number	B	C	D			F	H	J	K	L	M	N	Weight
					Friction Bearing	Ball Bearing	Roller Bearing								
4	1	4CHTEF2-*	4	4 <sup>5</sup> / <sub>16</sub>	2 <sup>3</sup> / <sub>16</sub>	1 <sup>5</sup> / <sub>16</sub>	5 <sup>3</sup> / <sub>4</sub>	1	1 <sup>5</sup> / <sub>16</sub>	1/4	8	3/8	3/8	3	
6	1 1/2	6CHTEF3-*	5 <sup>1</sup> / <sub>16</sub>	5 <sup>5</sup> / <sub>16</sub>	3 <sup>3</sup> / <sub>16</sub>	2 <sup>3</sup> / <sub>16</sub>	8 <sup>3</sup> / <sub>8</sub>	1	1 <sup>3</sup> / <sub>4</sub>	1/4	10 <sup>5</sup> / <sub>16</sub>	3/8	3/8	5	
9	1 1/2	9CHTEF3-*	6 <sup>5</sup> / <sub>16</sub>	7 <sup>1</sup> / <sub>16</sub>	3 <sup>3</sup> / <sub>4</sub>	2 <sup>3</sup> / <sub>16</sub>	9 <sup>3</sup> / <sub>8</sub>	1 1/2	2 <sup>3</sup> / <sub>4</sub>	1/4	13 <sup>3</sup> / <sub>4</sub>	1/2	3/8	10	
	2	9CHTEF4-*	6 <sup>5</sup> / <sub>16</sub>	7 <sup>1</sup> / <sub>16</sub>	4 <sup>1</sup> / <sub>4</sub>	2 <sup>1</sup> / <sub>2</sub>	9 <sup>3</sup> / <sub>8</sub>	1 1/2	2 <sup>3</sup> / <sub>4</sub>	1/4	13 <sup>3</sup> / <sub>4</sub>	1/2	3/8	10	
10	1 1/2	10CHTEF3-*	7 <sup>3</sup> / <sub>16</sub>	8 <sup>3</sup> / <sub>16</sub>	3 <sup>1</sup> / <sub>4</sub>	2 <sup>3</sup> / <sub>16</sub>	9 <sup>1</sup> / <sub>2</sub>	1 <sup>1</sup> / <sub>4</sub>	2 <sup>3</sup> / <sub>4</sub>	1/4	14 <sup>3</sup> / <sub>4</sub>	1/2	3/8	12	
	2	10CHTEF4-*	7 <sup>3</sup> / <sub>16</sub>	8 <sup>3</sup> / <sub>16</sub>	4 <sup>1</sup> / <sub>4</sub>	2 <sup>1</sup> / <sub>2</sub>	9 <sup>1</sup> / <sub>2</sub>	1 <sup>1</sup> / <sub>4</sub>	2 <sup>3</sup> / <sub>4</sub>	1/4	14 <sup>3</sup> / <sub>4</sub>	1/2	3/8	12	
12	2	12CHTEF4-*	8 <sup>1</sup> / <sub>16</sub>	9 <sup>5</sup> / <sub>16</sub>	4 <sup>1</sup> / <sub>4</sub>	2 <sup>3</sup> / <sub>16</sub>	12 <sup>1</sup> / <sub>4</sub>	1 <sup>5</sup> / <sub>8</sub>	2 <sup>3</sup> / <sub>4</sub>	1/4	16 <sup>1</sup> / <sub>4</sub>	5/8	1/2	22	
	2 1/16	12CHTEF5-*	8 <sup>1</sup> / <sub>16</sub>	9 <sup>5</sup> / <sub>16</sub>	5 <sup>1</sup> / <sub>4</sub>	2 <sup>1</sup> / <sub>16</sub>	12 <sup>1</sup> / <sub>4</sub>	1 <sup>1</sup> / <sub>2</sub>	2 <sup>3</sup> / <sub>4</sub>	1/4	16 <sup>1</sup> / <sub>4</sub>	5/8	1/2	22	
	3	12CHTEF6-*	8 <sup>1</sup> / <sub>16</sub>	9 <sup>5</sup> / <sub>16</sub>	6 <sup>1</sup> / <sub>4</sub>	3 <sup>3</sup> / <sub>4</sub>	12 <sup>1</sup> / <sub>4</sub>	1 <sup>1</sup> / <sub>2</sub>	2 <sup>3</sup> / <sub>4</sub>	1/4	16 <sup>1</sup> / <sub>4</sub>	5/8	1/2	22	
14	2 1/16	14CHTEF5-*	9 <sup>1</sup> / <sub>16</sub>	10 <sup>1</sup> / <sub>16</sub>	5 <sup>1</sup> / <sub>16</sub>	2 <sup>1</sup> / <sub>16</sub>	13 <sup>1</sup> / <sub>2</sub>	1 <sup>1</sup> / <sub>2</sub>	2 <sup>3</sup> / <sub>4</sub>	1/4	18 <sup>1</sup> / <sub>4</sub>	5/8	1/2	24	
	3	14CHTEF6-*	9 <sup>1</sup> / <sub>16</sub>	10 <sup>1</sup> / <sub>16</sub>	6 <sup>1</sup> / <sub>16</sub>	3 <sup>3</sup> / <sub>4</sub>	13 <sup>1</sup> / <sub>2</sub>	1 <sup>1</sup> / <sub>2</sub>	2 <sup>3</sup> / <sub>4</sub>	1/4	18 <sup>1</sup> / <sub>4</sub>	5/8	1/2	24	
16	3	16CHTEF6-*	10 <sup>1</sup> / <sub>16</sub>	12	6 <sup>1</sup> / <sub>16</sub>	3 <sup>1</sup> / <sub>16</sub>	14 <sup>1</sup> / <sub>16</sub>	2	3 <sup>3</sup> / <sub>4</sub>	5/16	21 <sup>1</sup> / <sub>4</sub>	5/8	5/8	44	
18	3	18CHTEF6-*	12 <sup>1</sup> / <sub>16</sub>	13 <sup>1</sup> / <sub>16</sub>	6 <sup>1</sup> / <sub>16</sub>	3 <sup>1</sup> / <sub>16</sub>	16	2	3 <sup>3</sup> / <sub>4</sub>	3/8	24 <sup>1</sup> / <sub>4</sub>	5/8	5/8	56	
	3 1/16	18CHTEF7-*	12 <sup>1</sup> / <sub>16</sub>	13 <sup>1</sup> / <sub>16</sub>	7 <sup>1</sup> / <sub>16</sub>	4 <sup>1</sup> / <sub>16</sub>	16	2	3 <sup>3</sup> / <sub>4</sub>	3/8	24 <sup>1</sup> / <sub>4</sub>	5/8	5/8	56	
20	3	20CHTEF6-*	13 <sup>1</sup> / <sub>16</sub>	15	6 <sup>1</sup> / <sub>16</sub>	3 <sup>3</sup> / <sub>8</sub>	19 <sup>1</sup> / <sub>4</sub>	2 <sup>1</sup> / <sub>4</sub>	3 <sup>3</sup> / <sub>4</sub>	3/8	26 <sup>1</sup> / <sub>4</sub>	5/8	5/8	92	
	3 1/16	20CHTEF7-*	13 <sup>1</sup> / <sub>16</sub>	15	7 <sup>1</sup> / <sub>16</sub>	4 <sup>3</sup> / <sub>8</sub>	19 <sup>1</sup> / <sub>4</sub>	2 <sup>1</sup> / <sub>4</sub>	3 <sup>3</sup> / <sub>4</sub>	3/8	26 <sup>1</sup> / <sub>4</sub>	5/8	5/8	92	
24	3 1/16	24CHTEF7-*	15 <sup>1</sup> / <sub>16</sub>	18 <sup>1</sup> / <sub>16</sub>	7 <sup>1</sup> / <sub>16</sub>	4 <sup>3</sup> / <sub>8</sub>	20	2 <sup>1</sup> / <sub>2</sub>	4 <sup>3</sup> / <sub>8</sub>	3/8	30 <sup>1</sup> / <sub>4</sub>	5/8	5/8	134	

-\*BB Ball Bearing  
-RB

-\*BR Bronze Bearing  
Roller Bearing

For Bolt Pattern see Page H-43



# Saddles — Feet Trough End Flanges

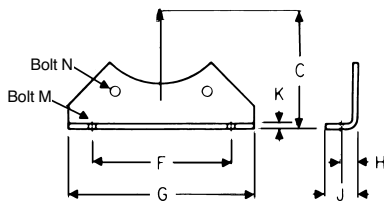

**Flange Foot**

Trough feet are used to support trough at trough connections.

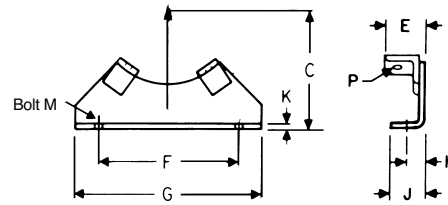

**Saddle**

Trough saddles are used to support trough where flange feet cannot be used at connections.

Conveyor Diameter	Part Number						Weight			
	Saddle			Flange Foot			Saddle		Flange Foot	
4	4TS			4TFF			1.5		1.5	
6	6TS			6TFF			2.0		2.0	
9	9TS			9TFF			4.5		4.5	
10	10TS			10TFF			5.0		5.0	
12	12TS			12TFF			6.0		6.0	
14	14TS			14TFF			7.0		7.0	
16	16TS			16TFF			8.0		7.5	
18	18TS			18TFF			10		9.5	
20	20TS			20TFF			13		12.5	
24	24TS			24TFF			15		14.5	

Conveyor Diameter	C	E	F	G	H	J	K	M*	N	P
4	4 $\frac{5}{8}$	1 $\frac{1}{16}$	5 $\frac{3}{4}$	7 $\frac{5}{8}$	1	1 $\frac{5}{8}$	$\frac{3}{16}$	$\frac{3}{8}$	$\frac{3}{8}$	$\frac{1}{4}$
6	5 $\frac{1}{8}$	1 $\frac{1}{8}$	8 $\frac{1}{8}$	10	1 $\frac{1}{4}$	2	$\frac{3}{8}$	$\frac{3}{8}$	$\frac{3}{8}$	$\frac{1}{4}$
9	7 $\frac{1}{8}$	1 $\frac{1}{2}$	9 $\frac{3}{8}$	12	1 $\frac{1}{2}$	2 $\frac{5}{8}$	$\frac{3}{8}$	$\frac{1}{2}$	$\frac{3}{8}$	$\frac{3}{8}$
10	8 $\frac{1}{8}$	1 $\frac{1}{2}$	9 $\frac{1}{2}$	12 $\frac{3}{8}$	1 $\frac{3}{4}$	2 $\frac{1}{2}$	$\frac{3}{8}$	$\frac{5}{8}$	$\frac{3}{8}$	$\frac{3}{8}$
12	9 $\frac{1}{8}$	1 $\frac{1}{2}$	12 $\frac{1}{4}$	15	1 $\frac{3}{4}$	2 $\frac{1}{2}$	$\frac{1}{4}$	$\frac{5}{8}$	$\frac{1}{2}$	$\frac{1}{2}$
14	10 $\frac{1}{8}$	1 $\frac{3}{4}$	13 $\frac{1}{2}$	16 $\frac{1}{2}$	1 $\frac{3}{8}$	2 $\frac{1}{2}$	$\frac{1}{4}$	$\frac{5}{8}$	$\frac{1}{2}$	$\frac{1}{2}$
16	12	1 $\frac{3}{4}$	14 $\frac{1}{4}$	18	2	3 $\frac{1}{4}$	$\frac{1}{4}$	$\frac{5}{8}$	$\frac{5}{8}$	$\frac{1}{2}$
18	13 $\frac{1}{8}$	1 $\frac{3}{4}$	16	19 $\frac{1}{8}$	2	3 $\frac{1}{4}$	$\frac{1}{4}$	$\frac{5}{8}$	$\frac{5}{8}$	$\frac{1}{2}$
20	15	2 $\frac{1}{4}$	19 $\frac{1}{4}$	22 $\frac{3}{4}$	2 $\frac{1}{4}$	3 $\frac{3}{4}$	$\frac{1}{4}$	$\frac{3}{4}$	$\frac{5}{8}$	$\frac{5}{8}$
24	18 $\frac{1}{8}$	2 $\frac{1}{4}$	20	24	2 $\frac{1}{4}$	4	$\frac{1}{4}$	$\frac{3}{4}$	$\frac{5}{8}$	$\frac{5}{8}$

\*Holes for Bolt M Slotted

① Add -F for Fitted

CONVEYORS

## Trough End Flanges

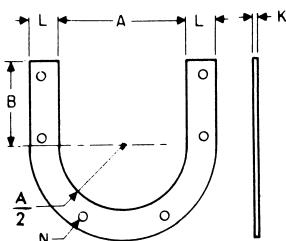

Size	Part No.	A		B	K	L	N	Weight	Red Rubber Gasket Part No.
		Trough Thickness							
		Thru 10 Ga.	$\frac{3}{16}$ & $\frac{1}{4}$						
4	4TF*	5 $\frac{1}{4}$	5 $\frac{5}{8}$	3 $\frac{3}{8}$	$\frac{1}{4}$	1 $\frac{1}{4}$	$\frac{3}{8}$	.09	4TFG
6	6TF*	7 $\frac{1}{4}$	7 $\frac{3}{8}$	4 $\frac{1}{4}$	$\frac{1}{4}$	1 $\frac{1}{2}$	$\frac{3}{8}$	1.5	6TFG
9	9TF*	10 $\frac{1}{4}$	10 $\frac{1}{2}$	5 $\frac{1}{8}$	$\frac{1}{4}$	1 $\frac{3}{4}$	$\frac{3}{8}$	2.4	9TFG
10	10TF*	11 $\frac{1}{4}$	11 $\frac{1}{2}$	6 $\frac{1}{8}$	$\frac{1}{4}$	1 $\frac{3}{4}$	$\frac{3}{8}$	2.6	10TFG
12	12TF*	13 $\frac{1}{4}$	13 $\frac{1}{2}$	7 $\frac{1}{8}$	$\frac{1}{4}$	2	$\frac{1}{2}$	5.6	12TFG
14	14TF*	15 $\frac{1}{4}$	15 $\frac{1}{2}$	9	$\frac{1}{4}$	2	$\frac{1}{2}$	6.5	14TFG
16	16TF*	17 $\frac{1}{4}$	17 $\frac{1}{2}$	10 $\frac{3}{8}$	$\frac{1}{4}$	2	$\frac{5}{8}$	7.4	16TFG
18	18TF*	19 $\frac{1}{4}$	19 $\frac{1}{2}$	11 $\frac{13}{16}$	$\frac{1}{4}$	2 $\frac{1}{2}$	$\frac{5}{8}$	10.2	18TFG
20	20TF*	21 $\frac{1}{4}$	21 $\frac{1}{2}$	13 $\frac{3}{16}$	$\frac{1}{4}$	2 $\frac{1}{2}$	$\frac{5}{8}$	11.3	20TFG
24	24TF*	25 $\frac{1}{4}$	25 $\frac{1}{2}$	16 $\frac{1}{2}$	$\frac{1}{4}$	2 $\frac{1}{2}$	$\frac{5}{8}$	15.5	24TFG

\*-10 used for troughs through 10 ga., -3 used for troughs  $\frac{3}{16}$  and  $\frac{1}{4}$  thick.

\*\*Subtract 1/8 when using plate trough.

# End Bearings



## KEEP THE HOUSING REPLACE THE INSERT.

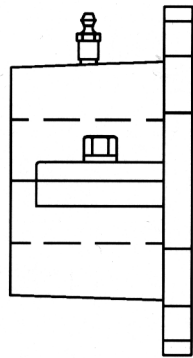
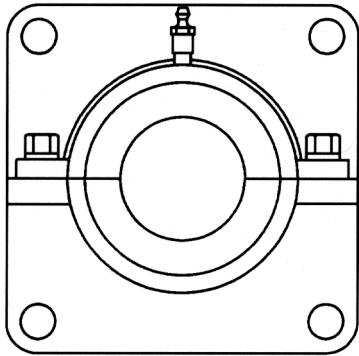

TEBH- Split Bearing Housings will help cut down on a plant's repair parts inventory, as well as the cost of the bearing. The rugged cast iron housing is not subject to wear, only the Style 220 Hanger bearing insert needs to be replaced.

The housings match CEMA standard ball bearing bolt pattern, so they can be used with most seals.

Split bearing housings are stocked in all *Martin* stocking facilities. Call your *Martin* distributor for more information.

## TROUGH END BEARING HOUSINGS

*Martin* Split Bearing Housings utilize *Martin* Style 220 Hanger Bearings.

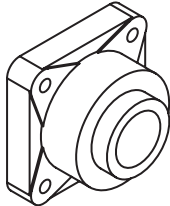
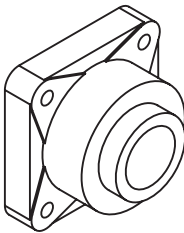
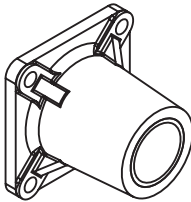
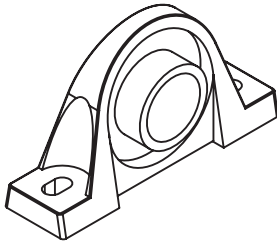
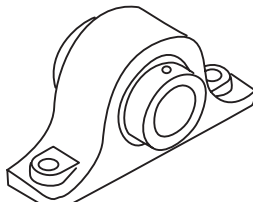
CONVEYORS	FLANGE UNITS	Mounted on trough end plate.		Ball Bearing Flange Unit
				Roller Bearing Flange Unit
				Bronze Sleeve Bearing Flange Unit
PILLOW BLOCKS	Mounted on pedestal of outboard bearing trough end.		Ball Bearing Pillow Block	
			Roller Bearing Pillow Block	





# End Bearings

## Bronze Flange Unit

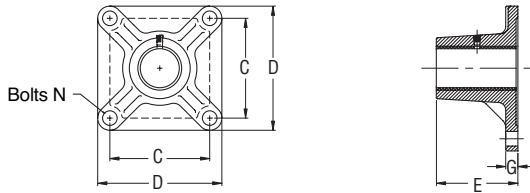

Bore	Part Number	C	D	E	G	N
1	TEB2BR	2 $\frac{3}{4}$	3 $\frac{3}{4}$	2	$\frac{7}{16}$	$\frac{3}{8}$
1 $\frac{1}{2}$	TEB3BR	4	5 $\frac{5}{8}$	3 $\frac{1}{4}$	$\frac{3}{4}$	$\frac{1}{2}$
2	TEB4BR	5 $\frac{1}{8}$	6 $\frac{1}{2}$	4 $\frac{1}{8}$	$\frac{7}{8}$	$\frac{5}{8}$
2 $\frac{1}{8}$	TEB5BR	5 $\frac{5}{8}$	7 $\frac{3}{8}$	4 $\frac{15}{16}$	1	$\frac{5}{8}$
3	TEB6BR	6	7 $\frac{3}{4}$	5 $\frac{1}{16}$	1 $\frac{1}{8}$	$\frac{3}{4}$
3 $\frac{1}{16}$	TEB7BR	6 $\frac{3}{4}$	9 $\frac{1}{4}$	6 $\frac{1}{4}$	1 $\frac{1}{4}$	$\frac{3}{4}$

## Ball Bearing Discharge Unit

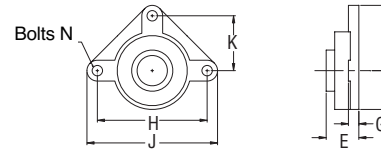

Bore	Part Number	E	G	H	J	K	L	M	N
1	TDB2BB	1 $\frac{3}{8}$	$\frac{1}{2}$	3 $\frac{3}{8}$	5 $\frac{3}{8}$	1 $\frac{15}{16}$	2 $\frac{11}{16}$	2	$\frac{3}{8}$
1 $\frac{1}{2}$	TDB3BB	2	$\frac{9}{16}$	5 $\frac{5}{8}$	7 $\frac{1}{4}$	2 $\frac{15}{16}$	3 $\frac{3}{8}$	2 $\frac{1}{2}$	$\frac{1}{2}$
2	TDB4BB	2 $\frac{1}{4}$	$\frac{5}{8}$	7 $\frac{1}{4}$	8	3 $\frac{3}{8}$	4	3	$\frac{5}{8}$
2 $\frac{1}{8}$	TDB5BB	2 $\frac{1}{2}$	$\frac{11}{16}$	8	9 $\frac{1}{8}$	4	4 $\frac{15}{16}$	3 $\frac{1}{2}$	$\frac{5}{8}$
3	TDB6BB	3 $\frac{1}{2}$	$\frac{7}{8}$	8 $\frac{1}{2}$	11	4 $\frac{1}{4}$	5 $\frac{1}{2}$	4	$\frac{3}{4}$
3 $\frac{1}{16}$	TDB7BB	4	1	9 $\frac{1}{2}$	12	4 $\frac{3}{4}$	6	4 $\frac{1}{2}$	$\frac{3}{4}$

## Ball Bearing Flange Unit

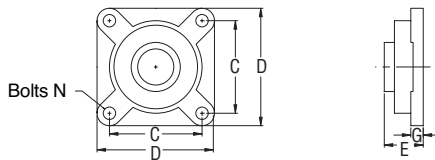

Bore	Part Number	C	D	E	G	N
1	TEB2BB	2 $\frac{3}{4}$	3 $\frac{3}{4}$	1 $\frac{3}{8}$	$\frac{1}{2}$	$\frac{3}{8}$
1 $\frac{1}{2}$	TEB3BB	4	5 $\frac{5}{8}$	2	$\frac{9}{16}$	$\frac{1}{2}$
2	TEB4BB	5 $\frac{1}{8}$	6 $\frac{1}{2}$	2 $\frac{1}{2}$	$\frac{11}{16}$	$\frac{5}{8}$
2 $\frac{1}{8}$	TEB5BB	5 $\frac{5}{8}$	7	2 $\frac{1}{2}$	$\frac{11}{16}$	$\frac{5}{8}$
3	TEB6BB	6	7 $\frac{3}{4}$	3 $\frac{1}{2}$	$\frac{7}{8}$	$\frac{3}{4}$
3 $\frac{1}{16}$	TEB7BB	6 $\frac{3}{4}$	8 $\frac{1}{16}$	4	1	$\frac{3}{4}$

## Trough End Bearing Housing

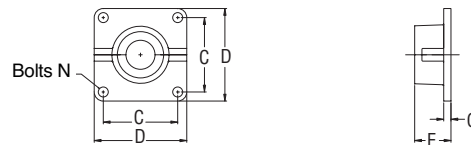

Bore	Part Number	C	D	E	G	N
1 $\frac{1}{2}$	TEBH3	4	5 $\frac{1}{4}$	2 $\frac{1}{2}$	$\frac{1}{2}$	$\frac{1}{2}$
2	TEBH4	5 $\frac{1}{8}$	6 $\frac{1}{8}$	2 $\frac{1}{2}$	$\frac{1}{2}$	$\frac{5}{8}$
2 $\frac{1}{8}$	TEBH5	5 $\frac{1}{8}$	6 $\frac{1}{8}$	3 $\frac{3}{16}$	$\frac{9}{16}$	$\frac{5}{8}$
3	TEBH6	6	7 $\frac{3}{4}$	3 $\frac{3}{8}$	$\frac{5}{8}$	$\frac{3}{4}$
3 $\frac{1}{16}$	TEBH7	7	9 $\frac{1}{4}$	4 $\frac{1}{4}$	$\frac{3}{4}$	$\frac{3}{4}$

Use #220 Type Hanger Bearings, See Page H-93.

## Roller Bearing Flange Unit

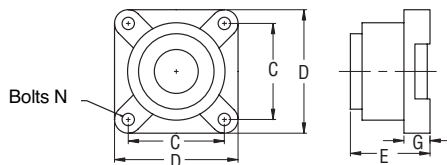

Bore	Part Number	C	D	E	G	N
1 $\frac{1}{2}$	TEB3R	4 $\frac{1}{8}$	5 $\frac{1}{8}$	3 $\frac{1}{2}$	1 $\frac{15}{16}$	$\frac{1}{2}$
2	TEB4R	4 $\frac{3}{8}$	5 $\frac{3}{8}$	3 $\frac{3}{8}$	1 $\frac{3}{8}$	$\frac{5}{8}$
2 $\frac{1}{8}$	TEB5R	5 $\frac{1}{8}$	6 $\frac{1}{8}$	4 $\frac{1}{8}$	1 $\frac{1}{2}$	$\frac{5}{8}$
3	TEB6R	6	7 $\frac{3}{4}$	4 $\frac{1}{16}$	1 $\frac{1}{8}$	$\frac{3}{4}$
3 $\frac{1}{16}$	TEB7R	7	9 $\frac{1}{4}$	5 $\frac{1}{4}$	1 $\frac{1}{8}$	$\frac{3}{4}$

## Ball Bearing Pillow Block

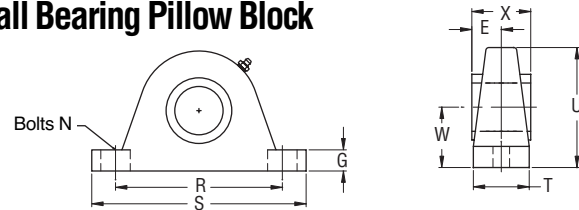

Bore	Part Number	E	G	N	R	S	T	U	W	X
1	TPB2BB	$\frac{13}{16}$	$\frac{13}{16}$	$\frac{3}{8}$	4 $\frac{1}{8}$	5 $\frac{1}{8}$	1 $\frac{1}{2}$	3 $\frac{3}{16}$	1 $\frac{1}{8}$	1 $\frac{1}{8}$
1 $\frac{1}{2}$	TPB3BB	1 $\frac{15}{16}$	1 $\frac{1}{4}$	$\frac{1}{2}$	5 $\frac{1}{8}$	6 $\frac{1}{8}$	2	4 $\frac{1}{8}$	2 $\frac{1}{4}$	1 $\frac{15}{16}$
2	TPB4BB	1 $\frac{15}{16}$	1 $\frac{3}{8}$	$\frac{5}{8}$	6 $\frac{1}{4}$	7 $\frac{1}{4}$	2 $\frac{1}{4}$	4 $\frac{1}{8}$	2 $\frac{1}{4}$	2 $\frac{3}{16}$
2 $\frac{1}{8}$	TPB5BB	1 $\frac{15}{16}$	1 $\frac{3}{8}$	$\frac{5}{8}$	7 $\frac{1}{4}$	9	2 $\frac{1}{2}$	5 $\frac{1}{2}$	2 $\frac{3}{4}$	2 $\frac{1}{8}$
3	TPB6BB	1 $\frac{15}{16}$	2 $\frac{1}{8}$	$\frac{7}{8}$	9	11 $\frac{1}{8}$	3 $\frac{1}{2}$	7 $\frac{1}{8}$	3 $\frac{1}{2}$	3 $\frac{1}{4}$
3 $\frac{1}{16}$	TPB7BB	2 $\frac{1}{4}$	2 $\frac{3}{8}$	$\frac{7}{8}$	11 $\frac{1}{8}$	13 $\frac{1}{8}$	4 $\frac{1}{4}$	8 $\frac{1}{4}$	4	3 $\frac{3}{8}$

## Bronze Discharge Unit

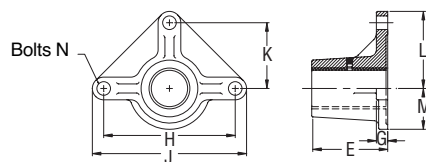

Bore	Part Number	E	G	H	J	K	L	M	N
1	TDB2BR	2	$\frac{1}{2}$	3 $\frac{3}{8}$	5 $\frac{3}{8}$	1 $\frac{15}{16}$	2 $\frac{11}{16}$	1	$\frac{3}{8}$
1 $\frac{1}{2}$	TDB3BR	3 $\frac{1}{4}$	$\frac{9}{16}$	5 $\frac{1}{8}$	7 $\frac{1}{4}$	2 $\frac{15}{16}$	3 $\frac{3}{8}$	1 $\frac{1}{4}$	$\frac{1}{2}$
2	TDB4BR	4 $\frac{1}{8}$	$\frac{5}{8}$	7 $\frac{1}{4}$	8	3 $\frac{3}{8}$	4	1 $\frac{1}{8}$	$\frac{5}{8}$
2 $\frac{1}{8}$	TDB5BR	4 $\frac{15}{16}$	$\frac{11}{16}$	8	9 $\frac{1}{8}$	4	4 $\frac{15}{16}$	1 $\frac{1}{8}$	$\frac{5}{8}$
3	TDB6BR	5 $\frac{1}{16}$	$\frac{7}{8}$	8 $\frac{1}{2}$	11	4 $\frac{1}{4}$	5 $\frac{1}{2}$	2 $\frac{1}{8}$	$\frac{3}{4}$
3 $\frac{1}{16}$	TDB7BR	6 $\frac{1}{4}$	1	9 $\frac{1}{2}$	12	4 $\frac{3}{4}$	6	2 $\frac{1}{2}$	$\frac{3}{4}$

## Roller Bearing Pillow Block

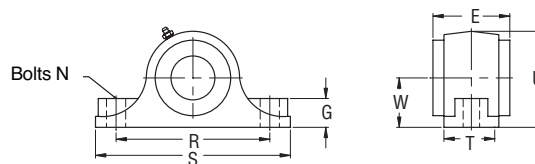

Bore	Part Number	E	G	N	R	S	T	U	W
1 $\frac{1}{2}$	TPB3R	3 $\frac{3}{8}$	1 $\frac{1}{4}$	$\frac{1}{2}$	6 $\frac{1}{4}$	7 $\frac{1}{8}$	2 $\frac{3}{8}$	4 $\frac{1}{4}$	2 $\frac{1}{8}$
2	TPB4R	3 $\frac{1}{2}$	1 $\frac{3}{8}$	$\frac{5}{8}$	7	8 $\frac{3}{8}$	2 $\frac{1}{2}$	4 $\frac{1}{2}$	2 $\frac{1}{4}$
2 $\frac{1}{8}$	TPB5R	4	1 $\frac{1}{8}$	$\frac{5}{8}$	8 $\frac{1}{2}$	10 $\frac{1}{2}$	2 $\frac{3}{8}$	5 $\frac{1}{2}$	2 $\frac{3}{4}$
3	TPB6R	4 $\frac{1}{2}$	1 $\frac{3}{8}$	$\frac{3}{4}$	9 $\frac{1}{2}$	12	3 $\frac{3}{8}$	6 $\frac{1}{4}$	3 $\frac{1}{2}$
3 $\frac{1}{16}$	TPB7R	5	2 $\frac{1}{4}$	$\frac{7}{8}$	11	14	3 $\frac{3}{8}$	7 $\frac{1}{2}$	3 $\frac{3}{4}$

CONVEYORS

# Thrust Bearings

*Martin*

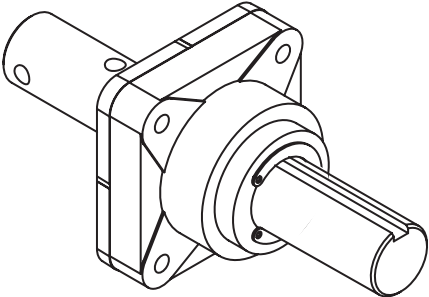
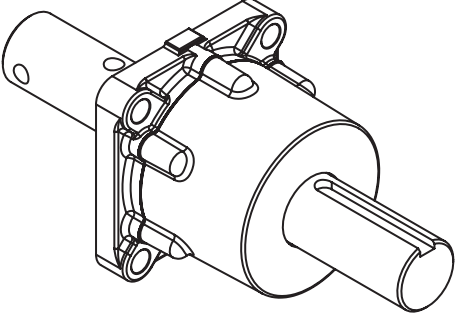
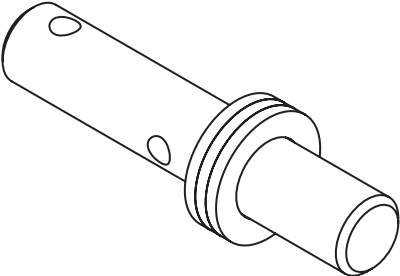
<p>TYPE E THRUST BEARINGS</p>		<p>Most common and economical thrust unit when a screw conveyor type drive is not being used.</p>
<p>TYPE H THRUST BEARINGS</p>		<p>For heavy duty thrust requirements.</p>
<p>BRONZE WASHER</p>		<p>Light duty applications only. Used inside the trough and when screw used in compression.</p>

CONVEYORS



# Thrust Bearings

## Type E Thrust Assembly

Type E roller thrust bearings are designed to carry thrust in both directions and carry radial load under normal conditions. This double roller bearing is furnished with a lip type seal plate and either drive or tail shaft whichever is applicable to conveyor design.

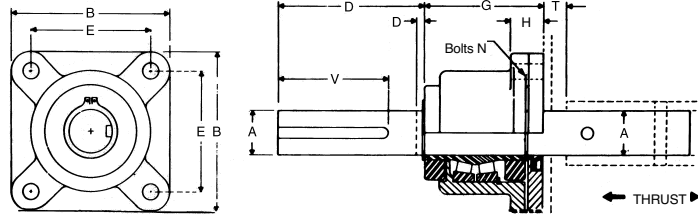

A Shaft Diameter	Part Number		B	D		E	G	H	N	T	V	Weight	
	Drive Shaft	End Shaft		Drive Shaft	End Shaft							Drive Shaft	End Shaft
1½	CT3D	CT3E	5½	4¾	¾	4½	4	1 11/16	½	1¼	4	22	20
2	CT4D	CT4E	5½	5	¾	4½	4½	1 11/16	½	1¼	4½	32	29
2 2/16	CT5D	CT5E	6½	5½	¾	5½	4 11/16	2	¾	1 13/16	5	50	44
3	CT6D	CT6E	7¾	6½	¾	6	5 5/16	2½	¾	1½	6	73	60
3 3/16	CT7D	CT7E	9¼	7½	¾	7	6	2½	¾	2½	7	111	88

## Heavy Duty RB End Thrust Bearings

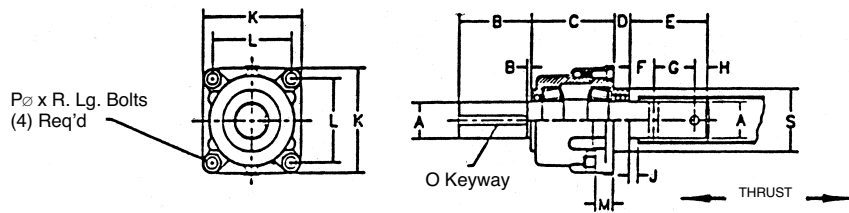

Dimensions in inches and average weight in pounds

A Shaft Dia.	With Drive Shaft		With Tail Shaft		B		C	D	E	F	G	H	J	K	L	M	O Keyway	P	R	S
	Part No.	Weight	Part No.	Weight	Drive Shaft	End Shaft														
1½	CTH3D	60	CTH3E	52	4½	¼	6¾	1½	4¾	1	3	7/8	1/8	7¼	5¾	1 1/16	¾ x 4¼	¾	2½	4¾
2	CTH4D	65	CTH4E	56	4½	¼	6¾	1½	4¾	1	3	7/8	1/8	7¼	5¾	1 1/16	¾ x 4¼	¾	2½	4¾
2 2/16	CTH5D	80	CTH5E	66	5 5/16	5/16	6¾	1¼	5 5/16	1½	3	1 1/16	1/16	8	6¼	1½	¾ x 5¼	¾	3	5½
3	CTH6D	145	CTH6E	119	6½	¼	8¼	1½	5½	1½	3	1	3/8	10	8	1¾	¾ x 5¼	1	3½	6
3 3/16	CTH7D	170	CTH7E	140	7½	¾	8¼	1½	7½	2½	4	1¼	7/8	10	8	1¾	¾ x 6¼	1	3½	6

Other shaft sizes available are 3 15/16", 4 1/16" & 4 1/16". Please consult factory.

## Thrust Washers

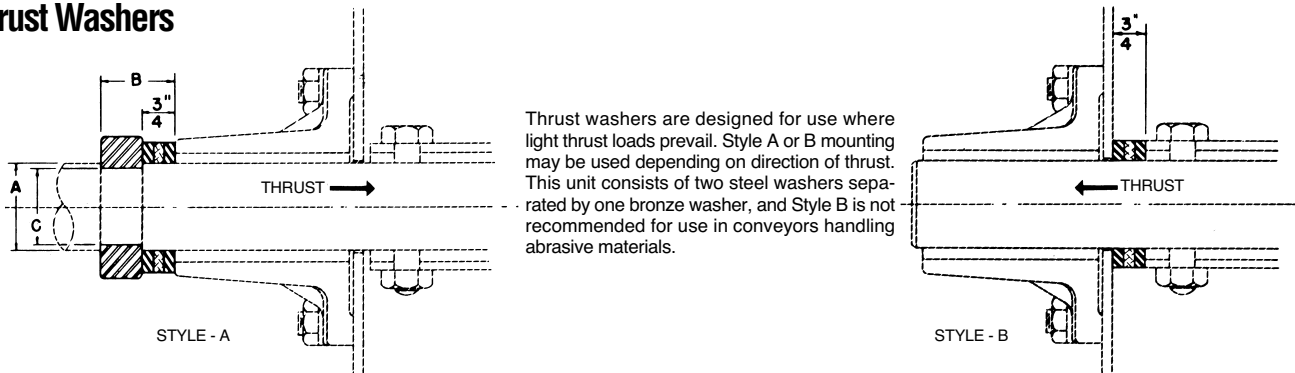

Thrust washers are designed for use where light thrust loads prevail. Style A or B mounting may be used depending on direction of thrust. This unit consists of two steel washers separated by one bronze washer, and Style B is not recommended for use in conveyors handling abrasive materials.

A Size Shaft	Washers & Collar Style A		Washer Set Style B		B	C
	Part No.	Weight	Part No.	Weight		
1½	CTCW3	2.4	CTW3	1	1¼	1¼
2	CTCW4	2.8	CTW4	1.25	1 1/16	1¾
2 2/16	CTCW5	3.9	CTW5	1.5	1½	2½
3	CTCW6	4.6	CTW6	2	1½	2¾
3 3/16	CTCW7	6.1	CTW7	3	1¾	3¼

CONVEYORS

# Shaft Seals

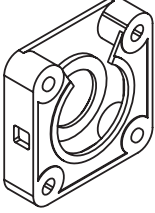
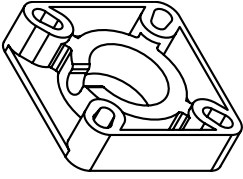
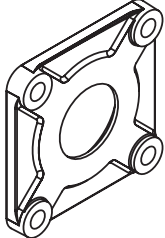
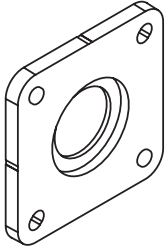
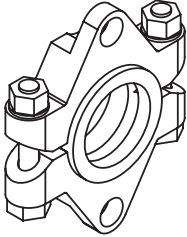
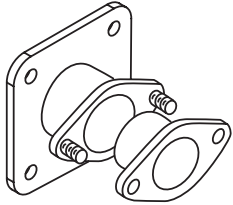
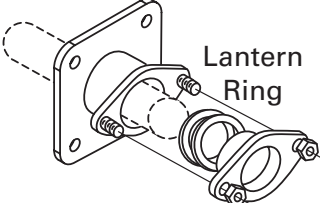

<p>WASTE PACK SEAL</p>		<p>Waste pack seals can be furnished with waste packing or in combination with lip seal. This type seal is normally installed between the trough end and bearing, but may be used separately on pedestal type trough ends. An opening is provided at top for repacking without removing seal from trough end. Can be used with flanged ball, roller or other standard 4-bolt bearings.</p>
<p><i>Martin</i> SUPER PACK SEAL</p>		<p><i>Martin</i> Super Pack Seal combines the heavy duty waste pack housing with the superior sealing characteristics of a Super Pack Seal. Seal may also be air or grease purged for difficult sealing applications.</p>
<p>PRODUCT DROP OUT SEAL</p>		<p>This flange type dust seal is designed for insertion between trough end and flanged ball bearing. The cast iron housing is open on all four sides for exit of material that might work past seal or lubricant from bearing.</p>
<p>PLATE SEAL</p>		<p>Plate seals are the most common and economical seal. It is normally furnished with a lip seal. This type seal is normally installed between the trough end and bearing, but may be used separately on pedestal type trough ends. Can be used with flanged ball, roller or other standard 4-bolt bearings.</p>
<p>SPLIT GLAND SEAL</p>		<p>Split gland compression type seals provide for easy replacement and adjustment of packing pressure on the shaft without removal of the conveyor. These seals can be installed inside or outside the end plates.</p>
<p>COMPRESSION TYPE PACKING GLAND SEAL</p>		<p>Flanged packing gland seals consist of an external housing and an internal gland which is forced into the housing to compress the packing. This is the most positive type shaft seal and may be used where minor pressure requirements are desired.</p>
<p>AIR PURGED SEAL</p>		<p>Air purge shaft seals are arranged for attaching to standard or special trough ends. A constant air pressure is maintained to prevent material from escaping from the trough along the shaft. The air purge seal is desirable for sealing highly abrasive materials.</p>



# Shaft Seals

## Compression Type Packing Gland Seal

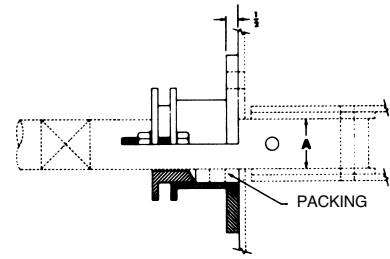
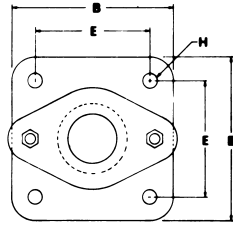

A Shaft Diameter	Part Number	B	E	H Bolts	Weight
1½	PGC3	5	4	½	14
2	PGC4	7½	5½	¾	18
2⅞	PGC5	7¾	5¾	¾	21
3	PGC6	8½	6	¾	27
3⅞	PGC7	9¼	6¾	¾	30

\*Braided rope graphite packing is standard. Other types available on request.

Flanged gland seals consist of an external housing and an internal gland which is forced into the housing to compress the packing. This is the most positive type shaft seal and may be used where pressure requirements are desired.

## Split Gland Seal

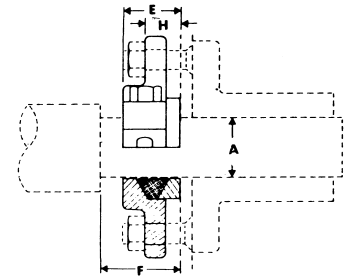
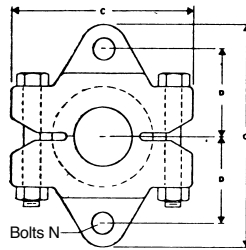

A Shaft Diameter	Part Number	C	D	E	F	G	H	N	Weight
1½	CSS3	4¾	2⅞	1⅞	2½	5⅞	⅞	½	5
2	CSS4	6¼	2⅞	1½	2½	6½	⅞	½	10
2⅞	CSS5	6¾	3⅞	1⅞	3¼	7¾	1	¾	15
3	CSS6	7½	3⅞	1⅞	3¼	8⅞	1	¾	22
3⅞	CSS7	8¾	4⅞	2⅞	3¼	10¼	1¼	¾	30

Split gland compression type seals provide for easy replacement and adjustment of packing pressure on the shaft without removal of the conveyor. These seals are normally installed inside the end plates.

## Flanged Product Drop-Out Seal

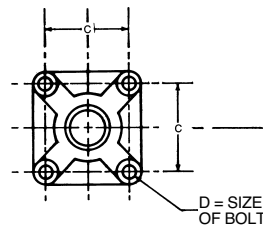

D = SIZE OF BOLT

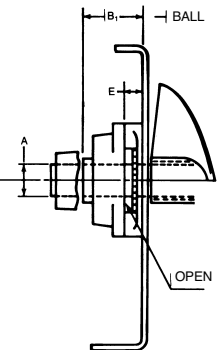

Dimensions in inches and average weight in pounds

A Shaft Diameter	Part Number	Weight	B <sub>1</sub>	C	E	D
1	CSFP2	1.75	2⅞	2¾	1⅞	¾
1½	CSFP3	3.4	2⅞	4	⅞	½
2	CSFP4	5.3	3⅞	5⅞	⅞	¾
2⅞	CSFP5	5.8	3⅞	5⅞	⅞	¾
3	CSFP6	7.2	4⅞	6	⅞	¾
3⅞	CSFP7	—	4⅞	6¾	1	¾

This flange type dust seal is designed for insertion between trough end and flanged bearing. The cast iron housing is open on all four sides for exit of material that might work past seal or lubricant from bearing.

CONVEYORS

# Shaft Seals



## Super Pack Seal

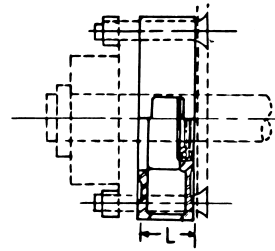
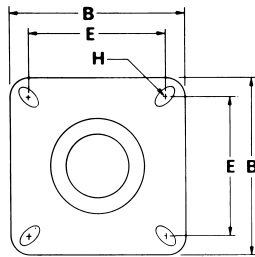

With Super Pack Seal

A Shaft	Part Number	B	L	E		H Bolts		Weight
				(-B)	(-R)	(-B)	(-R)	
1½	MSP3	5½	1¾	4	4½	½	½	6
2	MSP4	6½	1¾	5½	4%	¾	½	8
2⅞	MSP5	7%	1¾	5½	5%	¾	¾	10
3	MSP6	7¾	1¾	6	6	¾	¾	13
3⅞	MSP7	9¼	2¼	6¾	7	¾	¾	16

*Martin* Super Pack Seal combines the heavy duty waste pack housing with the superior sealing characteristics of a Super Pack Seal. Seal may also be air or grease purged for difficult sealing applications.

## Waste Pack Seal

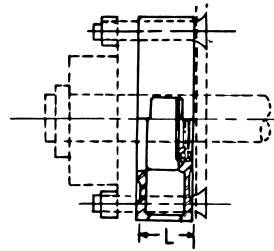
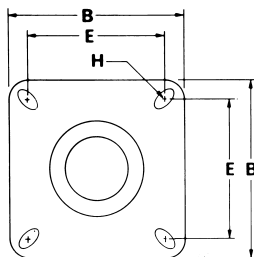

With Lip Seal

A Shaft	Part Number	B	L	E		H Bolts		Weight
				(-B)	(-R)	(-B)	(-R)	
1½	CSW3	5½	1¾	4	4½	½	½	6
2	CSW4	6½	1¾	5½	4%	¾	½	8
2⅞	CSW5	7%	1¾	5½	5%	¾	¾	10
3	CSW6	7¾	1¾	6	6	¾	¾	13
3⅞	CSW7	9¼	2¼	6¾	7	¾	¾	16

Waste pack seals are furnished with waste packing in combination with lip seal. This type seal is normally installed between the trough end and bearing, but may be used separately on pedestal type trough ends. An opening is provided at top for repacking without removing seal from trough end.

## Plate Seal

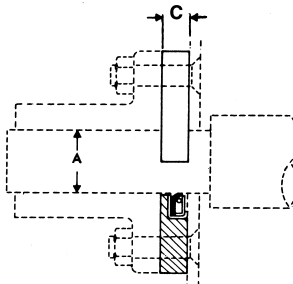
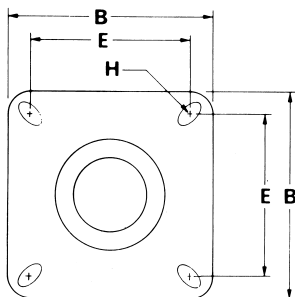

Plate seals are the most common and economical seal. They are furnished with a lip seal. This type seal is normally installed between the trough end and bearing, but may be used separately on pedestal type trough ends. Slotted mounting holes allow use with both ball and roller flanged bearings.

A Shaft Diameter	Part Number	B	C	E		H Bolts		Weight
				(-B)	(-R)	(-B)	(-R)	
1½	CSP3	5½	½	4	4½	½	½	2
2	CSP4	6½	½	5½	4%	¾	½	3
2⅞	CSP5	7%	½	5½	5%	¾	¾	4
3	CSP6	7¾	½	6	6	¾	¾	5
3⅞	CSP7	9¼	¾	6¾	7	¾	¾	8

*Martin*

# Conveyor Screws

## STANDARD PITCH, SINGLE FLIGHT

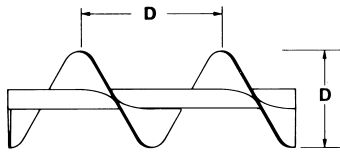

Conveyor screws with pitch equal to screw diameter are considered standard. They are suitable for a whole range of materials in most conventional applications.

## TAPERED, STANDARD PITCH, SINGLE FLIGHT

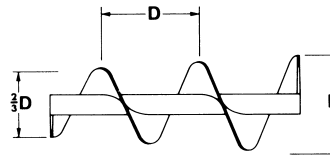

Price on Application

Screw flights increase from  $\frac{2}{3}$  to full diameter. Used in screw feeders to provide uniform withdrawal of lumpy materials. Generally equivalent to and more economical than variable pitch.

## SHORT PITCH, SINGLE FLIGHT

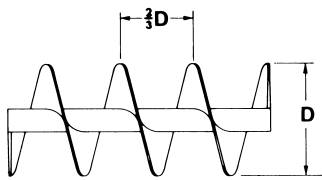

Flight pitch is reduced to  $\frac{2}{3}$  diameter. Recommended for inclined or vertical applications. Used in screw feeders. Shorter pitch reduces flushing of materials which fluidize.

## SINGLE CUT-FLIGHT, STANDARD PITCH

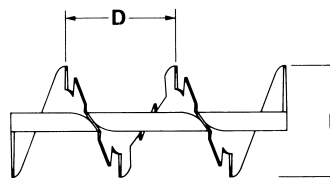

Screws are notched at regular intervals at outer edge. Affords mixing action and agitation of material in transit. Useful for moving materials which tend to pack.

## HALF PITCH, SINGLE FLIGHT

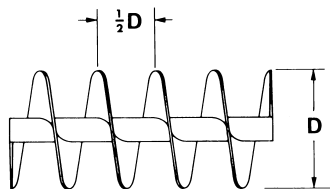

Similar to short pitch except pitch is reduced to  $\frac{1}{2}$  standard pitch. Useful for inclined applications, for screw feeders and for handling extremely fluid materials.

## CUT & FOLDED FLIGHT, STANDARD PITCH

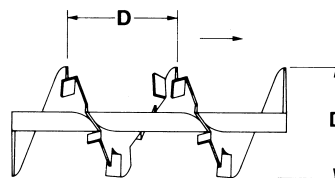

Folded flight segments lift and spill the material. Partially retarded flow provides thorough mixing action. Excellent for heating, cooling or aerating light substances.

## END DISC ON CONVEYOR SCREW

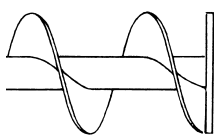

Price on Application

An end disc is the same diameter as the screw and is welded flush with the end of the pipe shaft at its discharge end and, of course, rotates with the screw. The end disc helps to keep discharging material away from the trough end seal.

## SINGLE FLIGHT RIBBON

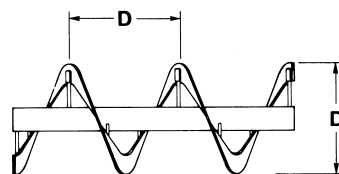

Price on Application

Excellent for conveying sticky or viscous materials. Open space between flighting and pipe eliminate collection and build-up of material.

## VARIABLE PITCH, SINGLE FLIGHT

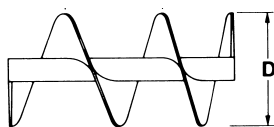

Price on Application

Flights have increasing pitch and are used in screw feeders to provide uniform withdrawal of fine, free flowing materials over the full length of the inlet opening.

## STANDARD PITCH WITH PADDLES

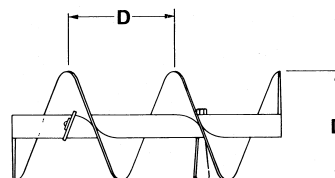

Adjustable paddles positioned between screw flights opposed flow to provide gentle but thorough mixing action.

## DOUBLE FLIGHT, STANDARD PITCH

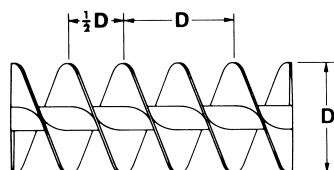

Double flight, standard pitch screws provide smooth regular material flow and uniform movement of certain types or materials.

## PADDLE

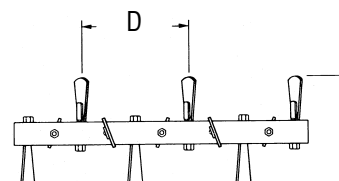

Adjustable paddles provide complete mixing action, and controlled material flow.

CONVEYORS



# Conveyor Screws



**Helicoid flights** are formed in a special rolling machine by forming a steel strip into a continuous one-piece helix of the desired diameter, pitch and thickness to fit conveyor screw pipes. The helicoid flight is tapered in cross section, with the thickness at the inner edge approximately twice the thickness of the outer edge.

**Sectional flights** are individual flights or turns blanked from steel plates and formed into a spiral or helix of the desired diameter and pitch to fit conveyor screw pipes. The flights are butt welded together to form a continuous conveyor screw. Modifications can be furnished, such as, fabrication from various metals, different flight thicknesses, other diameters and pitches. The butt weld flight is the same thickness in the full cross section.

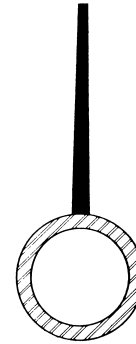

Helicoid Flight

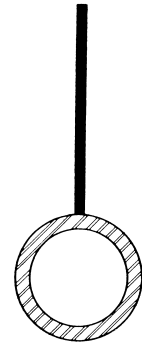

Sectional Flight

## Key to Conveyor Size Designation

The letter "H" indicates screw conveyor with helicoid flighting. The figures to the left of the letters indicate the nominal outside diameter of the conveyor in inches. The first figure following the letters is twice the diameter of the couplings in inches. The last two figures indicate the nominal thickness of flighting at the outer edge in  $\frac{1}{64}$ ". Thus conveyor 12H408 indicates 12" diameter helicoid conveyor for 2" couplings with flighting  $\frac{3}{64}$ " or  $\frac{1}{8}$ " thickness at outer edge. Hand of conveyor is indicated by "R" or "L" following the designation.

Comparison Table • helicoid flight and sectional flight conveyor screws

Screw Diameter, Inches	Helicoid Flight						Sectional Flight			
	Conveyor Screw Size Designation ▲	Former Designation	Coupling Diameter, Inches	Nominal Inside Diameter of Pipe, Inches	Thickness of Flight, Inches		Conveyor Screw Size Designation ▲	Coupling Diameter, Inches	Nominal Inside Diameter of Pipe, Inches	Thickness of Flight
					Inner Edge	Outer Edge				
4	4H206	4X	1	1¼	⅜	⅝				
6	6H304	6 Standard	1½	2	⅜	⅝	6S309 6S312	1½	2	10 ga. ⅜ in.
	6H308	6 X	1½	2	¼	⅝				
	6H312	6 XX	1½	2	⅜	⅝				
9	9H306	9 Standard	1½	2	⅜	⅝	9S307 9S407 9S312 9S412 9S416	1½	2	12 ga. 12 ga. ⅜ in. ⅜ in. ¼ in.
	9H406	9 Special	2	2½	⅜	⅝				
	9H312	9 X	1½	2	⅜	⅝				
	9H412	9 XX	2	2½	⅜	⅝				
	9H414	—	2	2½	⅞	⅝				
10	10H306	10 Standard	1½	2	⅜	⅝	10S309 10S412	1½	2	10 ga. ⅜ in.
	10H412	10 XX	2	2½	⅜	⅝				
12	12H408	12 Standard	2	2½	¼	⅝	12S409 12S509 12S412 12S512 12S616	2	2½	10 ga. 10 ga. ⅜ in. ⅜ in. ¼ in.
	12H508	12 Special	2⅞	3	¼	⅝				
	12H412	12 X	2	2½	⅜	⅝				
	12H512	12 XX	2⅞	3	⅜	⅝				
	12H614	—	3	3½	⅞	⅝				
14	14H508	14 Standard	2⅞	3	¼	⅝	14S509 14S616	2⅞	3	10 ga. ¼ in.
	14H614	14 XX	3	3½	⅞	⅝				
16	16H610	16 Standard	3	3½	⅜	⅝	16S609 16S616	3	3½	10 ga. ¼ in.
	16H614	—	3	4	⅞	⅝				

▲ Size designation: Examples: 12H412 and 12S412.  
 12 = screw diameter in inches  
 H = helicoid flight  
 S = sectional flight  
 4 = 2 times 2" coupling diameter  
 12 = thickness of flight at periphery in increments of  $\frac{1}{64}$ "

CONVEYORS





# Conveyor Screws (Helicoid)

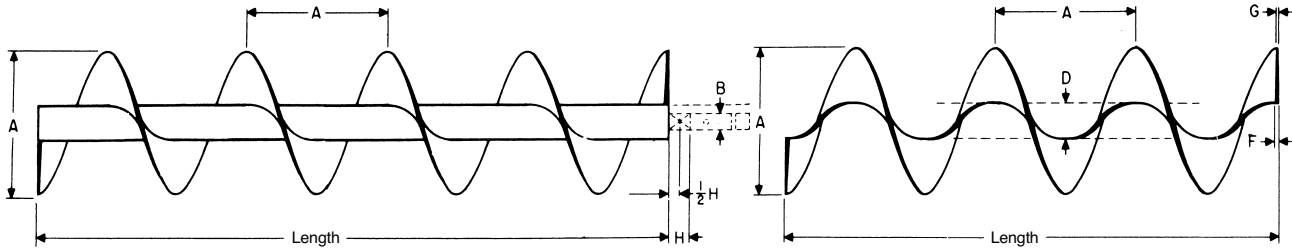

**Helicoid Conveyor Screw**

**Flighting**

Screw Diameter	Coupling Diameter	Size Part No. Conveyor Mounted	Size Part No. Flighting Only	D Pipe Size		Flight Thickness		H Coupling Bearing Length	Standard Length Feet-Inches	Average Weight			
				Inside	Outside	F	G			Complete Screw		Flighting Only	
						Inside	Outside			Standard Length	Per Foot	Standard Length	Per Foot
4	1	4H206-*	4HF206-*	1¼	1½	⅜	⅜	1½	9-10½	40	4	16	1.3
6	1½	6H304-*	6HF304-*	2	2½	⅜	⅜	2	9-10	52	5	14	1.4
	1½	6H308-*	6HF308-*	2	2½	¼	⅜	2	9-10	62	6	28	2.8
	1½	6H312-*	6HF312-*	2	2½	⅜	⅜	2	9-10	72	7	42	4.3
9	1½	9H306-*	9HF306-*	2	2½	⅜	⅜	2	9-10	70	7	31	3.2
	1½	9H312-*	9HF312-*	2	2½	⅜	⅜	2	9-10	101	10	65	6.1
	2	9H406-*	9HF406-*	2½	2½	⅜	⅜	2	9-10	91	9	30	3.0
	2	9H412-*	9HF412-*	2½	2½	⅜	⅜	2	9-10	121	12	60	6.6
	2	9H414-*	9HF414-*	2½	2½	⅜	⅜	2	9-10	131	13	70	6.3
10	1½	10H306-*	10HF306-*	2	2½	⅜	⅜	2	9-10	81	8	48	4.9
	2	10H412-*	10HF412-*	2½	2½	⅜	⅜	2	9-10	130	13	76	7.7
12	2	12H408-*	12HF408-*	2½	2½	¼	⅜	2	11-10	140	12	67	5.7
	2	12H412-*	12HF412-*	2½	2½	⅜	⅜	2	11-10	180	15	102	8.6
	2⅝	12H508-*	12HF508-*	3	3½	¼	⅜	3	11-9	168	14	64	5.4
	2⅝	12H512-*	12HF512-*	3	3½	⅜	⅜	3	11-9	198	17	96	8.2
14	3	12H614-*	12HF614-*	3½	4	⅜	⅜	3	11-9	220	18	112	9.3
	2⅝	14H508-*	14HF508-*	3	3½	¼	⅜	3	11-9	170	14	84	7.1
16	3	14H614-*	14HF614-*	3½	4	⅜	⅜	3	11-9	254	22	132	11.2
	3	16H610-*	16HF610-*	3½	4	⅜	⅜	3	11-9	228	19	120	10.0
▲	3	16H614-*	16HF614-*	4	4½	⅜	⅜	3	11-9	285	24	154	11.7
18 ▲	3	18H610-*	18HF610-*	3½	4	⅜	⅜	3	11-9	282	24	167	13.9

-\* R For Right Hand

-\* L For Left Hand

▲ Offered only in full pitch helicoid flighting.

CONVEYORS

# Conveyor Screws (Sectional)

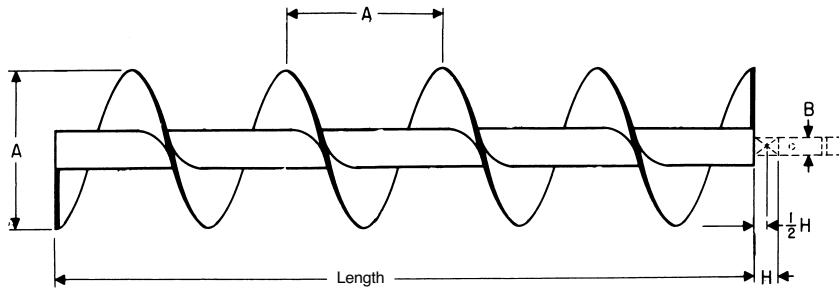

**Sectional Conveyor Screw**

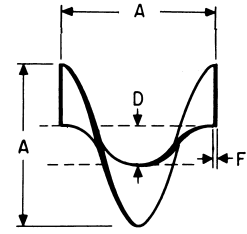

**Flight**

A Screw Diameter	B Coupling Diameter	Size Part No. Mounted Conveyor	Size Part No. Fighting Only	Pipe Size		F Flight Thickness	H Coupling Bearing Length	Standard Length Feet-Inches	Average Weight			Approx. Flights Per Foot
				Inside	D Outside				Standard Length	Per Foot	Flight Each	
6	1½	6S312-*	6SF312-*	2	2¾	⅜	2	9-10	75	7.5	1.7	2.0
	1½	6S316-*	6SF316-*	2	2¾	¼	2	9-10	90	8.0	2.2	2.0
9	1½	9S312-*	9SF312-*	2	2¾	⅜	2	9-10	95	9.5	4.3	1.33
	1½	9S316-*	9SF316-*	2	2¾	¼	2	9-10	130	13.0	5.5	1.33
	1½	9S324-*	9SF324-*	2	2¾	⅜	2	9-10	160	16.0	7.9	1.33
	2	9S412-*	9SF412-*	2½	2¾	⅜	2	9-10	115	11.5	4.3	1.33
	2	9S416-*	9SF416-*	2½	2¾	¼	2	9-10	130	13.0	5.5	1.33
	2	9S424-*	9SF424-*	2½	2¾	⅜	2	9-10	160	16.0	7.9	1.33
10	1½	10S312-*	10SF312-*	2	2¾	⅜	2	9-10	120	12.0	5.0	1.2
	1½	10S316-*	10SF316-*	2	2¾	¼	2	9-10	135	13.5	6.7	1.2
	1½	10S324-*	10SF324-*	2	2¾	⅜	2	9-10	165	16.5	8.7	1.2
	2	10S412-*	10SF412-*	2½	2¾	⅜	2	9-10	120	12.0	5.0	1.2
	2	10S416-*	10SF416-*	2½	2¾	¼	2	9-10	135	13.5	6.7	1.2
	2	10S424-*	10SF424-*	2½	2¾	⅜	2	9-10	165	16.5	8.7	1.2
12	2	12S412-*	12SF412-*	2½	2¾	⅜	2	11-10	156	13.0	7.2	1.0
	2	12S416-*	12SF416-*	2½	2¾	¼	2	11-10	204	17.0	9.7	1.0
	2	12S424-*	12SF424-*	2½	2¾	⅜	2	11-10	268	22.3	12.7	1.0
	2½	12S509-*	12SF509-*	3	3½	10 Ga.	3	11-9	160	14.0	5.7	1.0
	2½	12S512-*	12SF512-*	3	3½	⅜	3	11-9	178	14.8	7.2	1.0
	2½	12S516-*	12SF516-*	3	3½	¼	3	11-9	210	17.5	9.7	1.0
	2½	12S524-*	12SF524-*	3	3½	⅜	3	11-9	274	22.5	12.7	1.0
	3	12S612-*	12SF612-*	3½	4	⅜	3	11-9	198	16.5	7.2	1.0
	3	12S616-*	12SF616-*	3½	4	¼	3	11-9	216	18.0	9.7	1.0
	3	12S624-*	12SF624-*	3½	4	⅜	3	11-9	280	24.0	12.7	1.0

-\* R For Right Hand  
-\* L For Left Hand

CONVEYORS



# Conveyor Screws (Sectional)

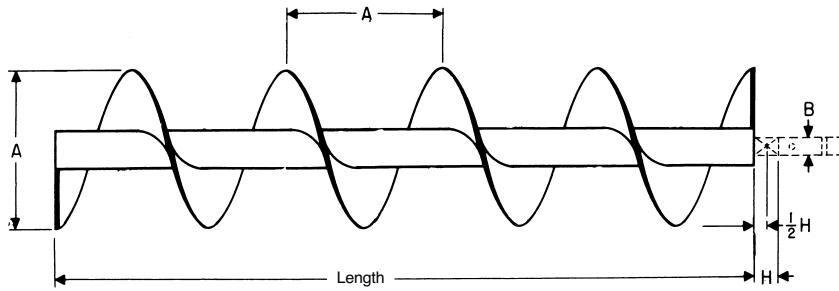

Sectional Conveyor Screw

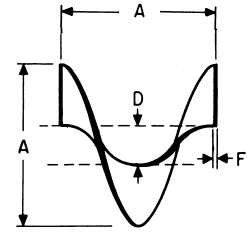

Flight

Screw Diameter	Coupling Diameter	Size Part No. Mounted Conveyor	Size Part No. Fighting Only	Pipe Size		F Flight Thickness	H Coupling Bearing Length	Standard Length Feet-Inches	Average Weight			Approx. Flights Per Foot
				Inside	D Outside				Standard Length	Per Foot	Flight Each	
14	2 <sup>7</sup> / <sub>16</sub>	14S512-*	14SF512-*	3	3 <sup>1</sup> / <sub>2</sub>	<sup>3</sup> / <sub>16</sub>	3	11-9	214	18.0	9.9	.86
		14S516-*	14SF516-*	3	3 <sup>1</sup> / <sub>2</sub>	<sup>1</sup> / <sub>4</sub>	3	11-9	240	20.0	13.2	.86
		14S524-*	14SF524-*	3	3 <sup>1</sup> / <sub>2</sub>	<sup>5</sup> / <sub>16</sub>	3	11-9	330	27.5	19.8	.86
	3	14S612-*	14SF612-*	3 <sup>1</sup> / <sub>2</sub>	4	<sup>3</sup> / <sub>16</sub>	3	11-9	222	19.0	9.9	.86
		14S616-*	14SF616-*	3 <sup>1</sup> / <sub>2</sub>	4	<sup>1</sup> / <sub>4</sub>	3	11-9	246	21.0	13.2	.86
		14S624-*	14SF624-*	3 <sup>1</sup> / <sub>2</sub>	4	<sup>5</sup> / <sub>16</sub>	3	11-9	342	29.0	19.8	.86
16	3	16S612-*	16SF612-*	3 <sup>1</sup> / <sub>2</sub>	4	<sup>3</sup> / <sub>16</sub>	3	11-9	234	20.0	14.0	.75
		16S616-*	16SF616-*	3 <sup>1</sup> / <sub>2</sub>	4	<sup>1</sup> / <sub>4</sub>	3	11-9	282	24.0	18.0	.75
		16S624-*	16SF624-*	3 <sup>1</sup> / <sub>2</sub>	4	<sup>5</sup> / <sub>16</sub>	3	11-9	365	31.0	25.5	.75
		16S632-*	16SF632-*	3 <sup>1</sup> / <sub>2</sub>	4	<sup>1</sup> / <sub>2</sub>	3	11-9	402	33.5	36.0	.75
18	3	18S612-*	18SF612-*	3 <sup>1</sup> / <sub>2</sub>	4	<sup>3</sup> / <sub>16</sub>	3	11-9	246	21.0	18.0	.67
		18S616-*	18SF616-*	3 <sup>1</sup> / <sub>2</sub>	4	<sup>1</sup> / <sub>4</sub>	3	11-9	294	25.0	24.0	.67
		18S624-*	18SF624-*	3 <sup>1</sup> / <sub>2</sub>	4	<sup>5</sup> / <sub>16</sub>	3	11-9	425	36.0	34.5	.67
		18S632-*	18SF632-*	3 <sup>1</sup> / <sub>2</sub>	4	<sup>1</sup> / <sub>2</sub>	3	11-9	530	44.0	46.0	.67
	3 <sup>7</sup> / <sub>16</sub>	18S712-*	18SF712-*	4	4 <sup>1</sup> / <sub>2</sub>	<sup>3</sup> / <sub>16</sub>	4	11-8	293	24.4	18.0	.67
		18S716-*	18SF716-*	4	4 <sup>1</sup> / <sub>2</sub>	<sup>1</sup> / <sub>4</sub>	4	11-8	345	28.8	24.0	.67
		18S724-*	18SF724-*	4	4 <sup>1</sup> / <sub>2</sub>	<sup>5</sup> / <sub>16</sub>	4	11-8	470	39.2	34.5	.67
		18S732-*	18SF732-*	4	4 <sup>1</sup> / <sub>2</sub>	<sup>1</sup> / <sub>2</sub>	4	11-8	570	47.5	46.0	.67
20	3	20S612-*	20SF612-*	3 <sup>1</sup> / <sub>2</sub>	4	<sup>3</sup> / <sub>16</sub>	3	11-9	300	26.0	20.0	.60
		20S616-*	20SF616-*	3 <sup>1</sup> / <sub>2</sub>	4	<sup>1</sup> / <sub>4</sub>	3	11-9	360	31.0	28.0	.60
		20S624-*	20SF624-*	3 <sup>1</sup> / <sub>2</sub>	4	<sup>5</sup> / <sub>16</sub>	3	11-9	410	33.4	40.0	.60
		20S632-*	20SF632-*	3 <sup>1</sup> / <sub>2</sub>	4	<sup>1</sup> / <sub>2</sub>	3	11-9	506	42.2	56.0	.60
	3 <sup>7</sup> / <sub>16</sub>	20S712-*	20SF712-*	4	4 <sup>1</sup> / <sub>2</sub>	<sup>3</sup> / <sub>16</sub>	4	11-8	310	27.0	20.0	.60
		20S716-*	20SF716-*	4	4 <sup>1</sup> / <sub>2</sub>	<sup>1</sup> / <sub>4</sub>	4	11-8	370	32.0	28.0	.60
		20S724-*	20SF724-*	4	4 <sup>1</sup> / <sub>2</sub>	<sup>5</sup> / <sub>16</sub>	4	11-8	475	40.0	40.0	.60
		20S732-*	20SF732-*	4	4 <sup>1</sup> / <sub>2</sub>	<sup>1</sup> / <sub>2</sub>	4	11-8	525	45.0	56.0	.60
24	3 <sup>7</sup> / <sub>16</sub>	24S712-*	24SF712-*	4	4 <sup>1</sup> / <sub>2</sub>	<sup>3</sup> / <sub>16</sub>	4	11-8	440	37.0	32.0	.50
		24S716-*	24SF716-*	4	4 <sup>1</sup> / <sub>2</sub>	<sup>1</sup> / <sub>4</sub>	4	11-8	510	43.0	42.0	.50
		24S724-*	24SF724-*	4	4 <sup>1</sup> / <sub>2</sub>	<sup>5</sup> / <sub>16</sub>	4	11-8	595	50.0	63.0	.50
		24S732-*	24SF732-*	4	4 <sup>1</sup> / <sub>2</sub>	<sup>1</sup> / <sub>2</sub>	4	11-8	690	60.0	84.0	.50

-\* R For Right Hand  
-\* L For Left Hand

CONVEYORS

# Conveyor Screws (Ribbon)



Ribbon flight conveyor screws consist of sectional flights, butt-welded together to form a continuous helix. Flights are secured to the pipe by supporting legs. Both ends of the pipe are prepared with internal collars and drilling to accept couplings, drive shafts, and end shafts. They are used to convey sticky, gummy, or viscous substances, or where the material tends to adhere to flighting and pipe.

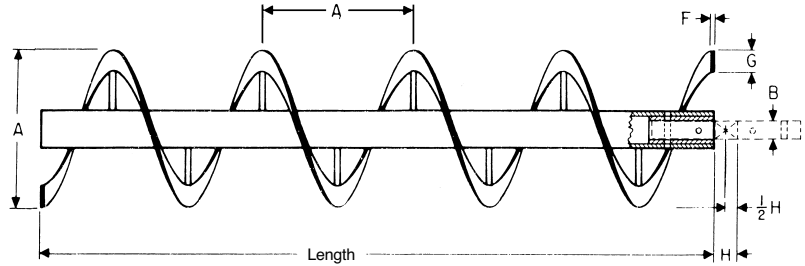

Ribbon Conveyor Screw

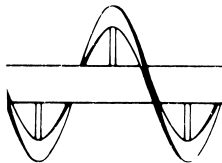

Post

Integral (Int)  
Leg

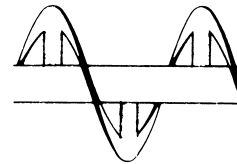

A Screw Diameter	B Coupling Diameter	Size Part No. Mounted Conveyor	Pipe Size		Flight Size		H Coupling Bearing Length	Standard Length Feet-Inches	Weight	
			Inside	Outside	F Thickness	G Width			Complete Screw	
									Standard Length	Per Foot
6	1½	6R312-*	2	2¾	⅜	1	2	9-10	65	6.5
9	1½	9R316-*	2	2¾	¼	1½	2	9-10	100	10
10	1½	10R316-*	2	2¾	¼	1½	2	9-10	110	11
12	2	12R416-*	2½	2¾	¼	2	2	11-10	180	15
	2	12R424-*	2½	2¾	⅝	2½	2	11-10	216	19
	2⅞	12R524-*	3	3½	⅝	2½	3	11-9	240	21
14	2⅞	14R516-*	3	3½	¼	2½	3	11-9	228	19
	2⅞	14R524-*	3	3½	⅝	2½	3	11-9	264	22
	3	14R624-*	3½	4	⅝	2½	3	11-9	288	25
16	3	16R616-*	3½	4	¼	2½	3	11-9	276	24
	3	16R624-*	3½	4	⅝	2½	3	11-9	324	28
18	3	18R624-*	3½	4	⅝	3	3	11-9	384	33
20	3⅞	20R724-*	4	4½	⅝	3	4	11-8	408	35
24	3⅞	24R724-*	4	4½	⅝	3	4	11-8	424	36

-\* R For Right Hand  
-\* L For Left Hand

CONVEYORS



# Conveyor Screws

## Quick Detachable (QD) Helicoid Conveyor

Q.D. — Quick Detachable conveyor screws are designed for convenient removal from the conveyor assembly. Each section of screw has a Q.D. cap at one end of the pipe. By removing this cap, a conveyor screw section can quickly and easily be removed and returned to the conveyor assembly without disturbing the other screw sections. Quick Detachable conveyor can be furnished both in helicoid and buttweld construction.

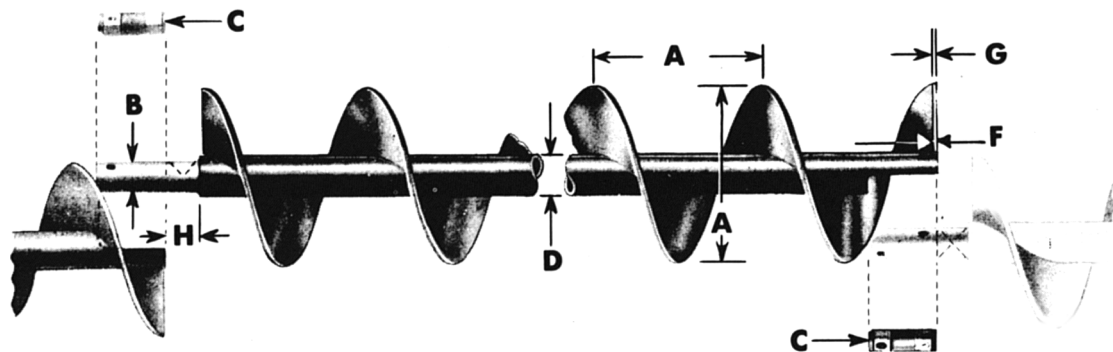

R.H. Shown

A Nominal Conveyor Diameter	Size Part No. Mounted Conveyor	B Coupling Diameter	Standard-Length Feet-Inches End to End of Pipe	C Cap Part Number	D Pipe Size		Flight Thickness		H Coupling Bearing Length	Average Weight	
					Inside	Outside	F Inside	G Outside		Standard Length	Per Foot
6	6HQ304-*	1½	9'-10	3QDC2	2	2¾	⅛	⅙	2	52	5
	6HQ308-*						¼	⅙		62	6
	6HQ312-*						⅜	⅙		72	7
9	9HQ306-*	1½	9'-10	3QDC2	2	2¾	⅜	⅜	2	70	7
	9HQ312-*						⅜	⅙		101	10
	9HQ406-*	2	9'-10	4QDC25	2½	2¾	⅜	⅜	2	91	9
	9HQ412-*						⅜	⅙		121	12
	9HQ414-*						⅞	⅜		131	13
10	10HQ306-*	1½	9'-10	3QDC2	2	2¾	⅜	⅜	2	81	8
	10HQ412-*	2	9'-10	4QDC25	2½	2¾	⅜	⅙	2	130	13
12	12HQ408-*	2	11'-10	4QDC25	2½	2¾	¼	⅙	2	140	12
	12HQ412-*						⅜	⅙		180	15
	12HQ508-*	2⅞	11'-9	5QDC3	3	3½	¼	⅙	3	168	14
	12HQ512-*						⅜	⅙		198	17
12HQ614-*	3	11'-9	6QDC35	3½	4	⅞	⅜	3	220	18	
14	14HQ508-*	2⅞	11'-9	5QDC3	3	3½	¼	⅙	3	170	14
	14HQ614-*	3	11'-9	6QDC35	3½	4	⅞	⅜	3	254	22
16	16HQ610-*	3	11'-9	6QDC35	3½	4	⅝	⅜	3	228	19
	16HQ614-*	3	11'-9	6QDC4	4	4½	⅞	⅜	3	285	23.8

Note: Q.D. caps are not recommended on the drive shaft end.

—\* R For Right Hand

—\* L For Left Hand

CONVEYORS

# Conveyor Screws



## Quick Detachable (QD) Sectional Spiral Conveyors

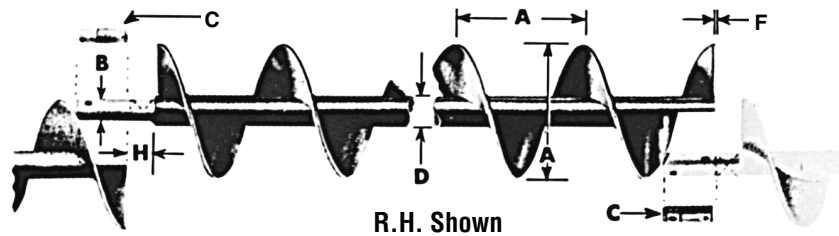

A Nominal Conveyor Diameter	Size Part No. Mounted Conveyor	B Coupling Diameter	Standard Length Feet-Inches End to End of Pipe	C Cap Part Number	D Pipe Size		F Flight Thickness	H Coupling Bearing Length	Average Weight	
					Inside	Outside			Standard Length	Per Foot
6	6SQ307-*	1½	9'-10	3QDC2	2	2%	12	2	62	6.2
	6SQ309-*						10		65	6.5
	6SQ312-*						⅜		75	7.5
	6SQ316-*						¼		90	8.0
9	9SQ307-*	1½	9'-10	3QDC2	2	2%	12	2	73	7.3
	9SQ309-*						10		80	8.0
	9SQ312-*						⅜		95	9.5
	9SQ316-*						¼		120	13
	9SQ407-*	2	9'-10	4QDC25	2½	2%	12	2	90	9
	9SQ409-*						10		100	10
	9SQ412-*						⅜		115	11.5
	9SQ416-*						¼		130	13.0
	9SQ424-*						⅝		160	16
10	10SQ309-*	1½	9'-10	3QDC2	2	2%	10	2	85	8.5
	10SQ412-*	2	9'-10	4QDC25	2½	2%	⅜	2	120	12.0
	10SQ416-*						¼		135	13.5
12	12SQ409-*	2	11'-10	4QDC25	2½	2%	10	2	140	12.0
	12SQ412-*						⅜		156	13.0
	12SQ416-*						¼		204	17
	12SQ509-*	2⅞	11'-9	5QDC3	3	3½	10	3	160	14
	12SQ512-*						⅜		178	15
	12SQ612-*						3		11'-9	6QDC35
12SQ616-*	¼	216	18.0							
12SQ624-*	⅝	280	24							
14	14SQ509-*	2⅞	11'-9	5QDC3	3	3½	10	3	185	16
	14SQ512-*						⅜		214	18
	14SQ612-*	3	11'-9	6QDC35	3½	4	⅜	3	222	19
	14SQ616-*						¼		246	21
14SQ624-*	⅝						342		29	
16	16SQ609-*	3	11'-9	6QDC35	3½	4	10	3	210	18
	16SQ612-*						⅜		234	20
	16SQ616-*						¼		282	24
	16SQ624-*						⅝		365	31
18	18SQ612-*	3	11'-9	6QDC35	3½	4	⅜	3	246	21
	18SQ616-*						¼		294	25
	18SQ624-*						⅝		425	36
20	20SQ612-*	3	11'-9	6QDC35	3½	4	⅜	3	300	26
	20SQ616-*						¼		360	31
	20SQ724-*	3⅞	11'-8	7QDC4	4	4½	⅝	4	475	40
24	24SQ712-*	3⅞	11'-8	7QDC4	4	4½	⅜	4	410	37
	24SQ716-*						¼		510	43
	24SQ724-*						⅝		595	50

\* R For Right Hand  
\* L For Left Hand



# Conveyor Screw (Components)

## Coupling Bolts

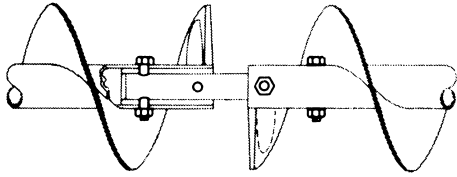

Conveyor coupling bolts are manufactured from special analysis high-torque steel. Close tolerance and no threads inside of the conveyor pipe allow for a minimum of wear. Lock nuts are furnished with each bolt.

Coupling Diameter	Outside Pipe Diameter	Bolt Size	Part Number Standard	Weight Each Lbs.
1	1 $\frac{1}{2}$	$\frac{3}{8}$ x 2 $\frac{1}{16}$	CCB2	.13
1 $\frac{1}{2}$	2 $\frac{1}{2}$	$\frac{1}{2}$ x 3	CCB3	.2
2	2 $\frac{3}{4}$	$\frac{5}{8}$ x 3 $\frac{3}{8}$	CCB4	.45
2 $\frac{1}{8}$	3 $\frac{1}{2}$	$\frac{5}{8}$ x 4 $\frac{1}{8}$	CCB5	.5
3	4	$\frac{3}{4}$ x 5	CCB6	.85
3	4 $\frac{1}{2}$	$\frac{3}{4}$ x 5 $\frac{1}{2}$	CCB6A	.9
3 $\frac{1}{8}$	4 $\frac{1}{2}$	$\frac{7}{8}$ x 5 $\frac{1}{2}$	CCB7	1.29

## Internal Collar

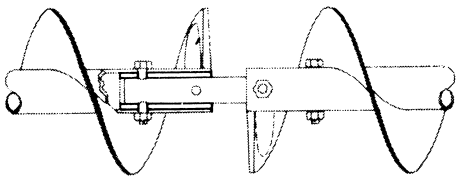

Internal collars are made from seamless tubing machined for a press fit in the conveyor pipe. When installed at the factory collars are jig drilled and plug welded into the pipe. No drilling in replacement collars is furnished allowing for field drilling to match existing bolt holes.

Coupling Diameter	Inside Pipe Diameter	Part Number Standard	Weight Each Lbs.
1	1 $\frac{1}{4}$	CIC2	.58
1 $\frac{1}{2}$	2	CIC3	2.06
2	2 $\frac{1}{2}$	CIC4	2.16
2 $\frac{1}{8}$	3	CIC5	3.72
3	3 $\frac{1}{2}$	CIC6	4.03
3	4	CIC6A	8.03
3 $\frac{1}{8}$	4	CIC7	6.52

## Discharge End

## End Lugs

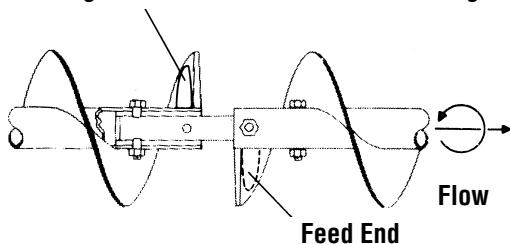

End lugs are welded opposite the carrying side of the conveyor flight and provide maximum support with minimum obstruction of material flow.

Conveyor Diameter	Part Number		Weight Each Lbs.
	Intake End Standard	Discharge End Standard	
6	6CELI-*	6CELD-*	.06
9	9CELI-*	9CELD-*	.15
10	9CELI-*	9CELD-*	.15
12	12CELI-*	12CELD-*	.2
14	12CELI-*	12CELD-*	.2
16	16CELI-*	16CELD-*	.4
18	16CELI-*	16CELD-*	.4
20	16CELI-*	16CELD-*	.4
24	16CELI-*	16CELD-*	.4

-\* R For Right Hand Flight  
-\* L For Left Hand Flight

CONVEYORS

# Shaft



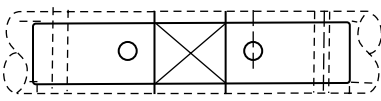
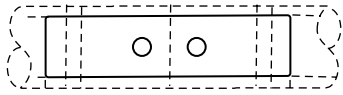

## Coupling Shafts

	<b>cc</b>	<b>5</b>	
<b>Coupling Part</b>	<b>Coupling Diameter</b>		
CC — Coupling Shaft Std.*	2 — 1"	5 — 2-7/16"	* Add suffix H if Hardened
CCC — Close Coupling Shaft	3 — 1-1/2"	6 — 3"	
CHE — Hanger End Shaft*	4 — 2"	7 — 3-7/16"	

COUPLING		Conveyor couplings are used to join individual lengths of conveyor screws and allow for rotation within the hanger bearing. C-1045 steel couplings are normally furnished; however couplings with hardened bearing surfaces may be furnished where highly abrasive materials are being conveyed. Jig drilling allows for ease of installation.
CLOSE		Close couplings are used to adjoin conveyor screws where no hanger is required. Jig drilling allows for ease of installation.

## Drive & End Shafts

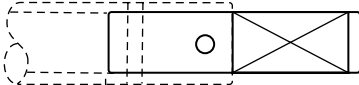
	<b>1</b>	<b>CD</b>	<b>5</b>	<b>BB</b>	<b>W</b>	
<b>Drive Shaft Number</b>	<b>Type</b>		<b>Coupling Diameter</b>		<b>Bearing Type</b>	
Drive Shaft Only	CD — Drive Shaft	2 — 1"	5 — 2-7/16"	B — Bronze	<b>Seal Type</b> (Delete if without seal) P — Plate W — Waste Pack	
1 — #1	CE — End Shaft	3 — 1-1/2"	6 — 3"	BB — Ball		
		4 — 2"	7 — 3-7/16"	RB — Roller		

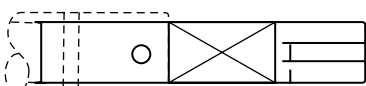
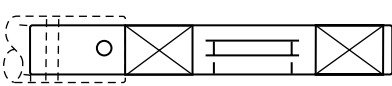
END		End shafts serve only to support the end conveyor section and are therefore usually supplied in cold rolled steel. End shafts are jig drilled for ease of assembly and close diametral tolerances are held for proper bearing operation.
HANGER END		Hanger end shafts are designed to connect only one conveyor section to a hanger bearing. These shafts may also be used in pairs to divide an excessively long conveyor assembly between two drives.
#1 DRIVE		No. 1 drive shafts are normally used where standard end plates are furnished. Jig drilling allows for ease of installation.
SPECIAL DRIVE		Length, bearing location, seals and keyway location and size as required.

CONVEYORS





# No. 1 Drive Shaft

No. 1 drive shafts are normally used where standard end plates are furnished. Jig drilling allows for ease of installation.

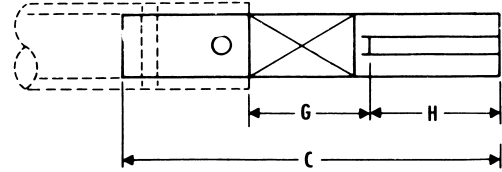

No. 1 Drive Shaft Used Without Seal*											
Bronze Bearing						Ball Bearing					
Shaft Diameter	Part Number	C	G	H	Weight	Shaft Diameter	Part Number	C	G	H	Weight
1	1CD2B	9½	3½	3	2.0	1	1CD2BB	9	3	3	1.8
1½	1CD3B	12¾	4¾	3¾	6.3	1½	1CD3BB	11½	3½	3¾	5.6
2	1CD4B	15	5¾	4½	13.3	2	1CD4BB	13¾	3¾	4½	11.5
2⅞	1CD5B	17¾	7	5½	21.0	2⅞	1CD5BB	15¾	4¾	5½	18.0
3	1CD6B	19¾	8¾	6	37.0	3	1CD6BB	16¾	5¾	6	32.0
3⅞	1CD7B	23	9	7¼	60.4	3⅞	1CD7BB	20¾	6¾	7¼	52.5

\*\*Consult Factory

No. 1 Drive Shaft Used With Plate or Product Drop Out Seals*											
Bronze Bearing						Ball Bearing					
Shaft Diameter	Part Number	C	G	H	Weight	Shaft Diameter	Part Number	C	G	H	Weight
1	1CD2B-P	10	4	3	2.1	1	1CD2BB-P	9½	3½	3	2.0
1½	1CD3B-P	13¾	5¼	3¾	6.6	1½	1CD3BB-P	12¾	4¾	3¾	6.2
2	1CD4B-P	15¾	6¼	4½	14.1	2	1CD4BB-P	14	4¾	4½	12.5
2⅞	1CD5B-P	18¾	8	5½	24.3	2⅞	1CD5BB-P	15¾	5½	5½	21
3	1CD6B-P	19¾	8¾	6	38.0	3	1CD6BB-P	17½	6½	6	35
3⅞	1CD7B-P	24¾	10¾	7¼	61.0	3⅞	1CD7BB-P	21½	7½	7¼	56.5

\*\*Consult Factory

No. 1 Drive Shaft Used With Waste Pack Seal*											
Bronze Bearing						Ball Bearing					
Shaft Diameter	Part Number	C	G	H	Weight	Shaft Diameter	Part Number	C	G	H	Weight
1	1CD2B-W	11	4¼	3	2.2	1	1CD2BB-W	10½	3¾	3	2.0
1½	1CD3B-W	14½	6½	3¾	7.2	1½	1CD3BB-W	13¾	5¼	3¾	6.4
2	1CD4B-W	16¾	7½	4½	14.9	2	1CD4BB-W	14¾	5¾	4½	13.0
2⅞	1CD5B-W	19¾	8¾	5½	23.3	2⅞	1CD5BB-W	16¾	6½	5½	20.5
3	1CD6B-W	20¾	9¾	6	40.5	3	1CD6BB-W	18¾	7¾	6	35.5
3⅞	1CD7B-W	25¾	11¾	7¼	66.3	3⅞	1CD7BB-W	22¾	8¾	7¼	58.4

\*Shaft length allows for ½ hanger bearing length as clearance between end plate and screw

\*\*Consult Factory

CONVEYORS

# No. 2 and No. 3 Drive Shafts



## No. 2 Drive Shaft

No. 2 drive shafts are used where pedestal type trough ends with single bearing are furnished. Jig drilling allows for ease of installation.

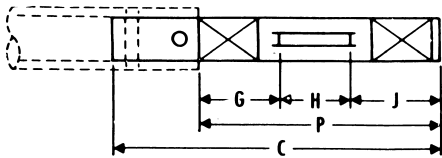

Shaft Diameter	Part Number	C	G	H	J	P	Weight
1	2CD2	11	3/4	2 1/4	2 1/2	8	2.5
1 1/2	2CD3	16 1/2	5	3 3/4	3 1/2	11 1/4	8.3
2	2CD4	18 3/4	5 1/4	4 1/4	4 1/2	14	17.0
2 7/16	2CD5	21 1/4	6	5 1/2	5 1/2	17	29.0
3	2CD6	23 1/2	6 1/2	5 1/2	6 1/2	18 1/2	49.0
3 7/16	2CD7	27	6 3/4	6	7 1/2	20 1/4	75.0

## No. 3 Drive Shaft

No. 3 drive shafts are used where pedestal type trough ends with double bearings are furnished. Jig drilling allows for ease of installation.

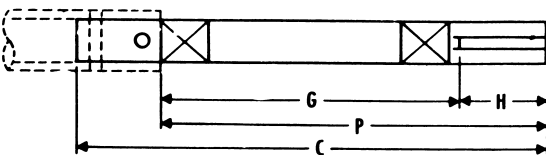

Shaft Diameter	Part Number	C	G	H	P	Weight
1	3CD2	13	7 1/4	2 1/4	10	3
1 1/2	3CD3	19 1/4	11 1/4	3 3/4	14 1/2	10
2	3CD4	25 1/4	16 1/4	4 1/4	20 1/2	21
2 7/16	3CD5	28 1/4	18 1/4	5 1/4	24	36
3	3CD6	33 1/2	22 1/4	6 1/4	28 1/2	62
3 7/16	3CD7	39 1/4	25 1/4	7 1/4	32 1/2	95

CONVEYORS

## Drive Shaft Keyways

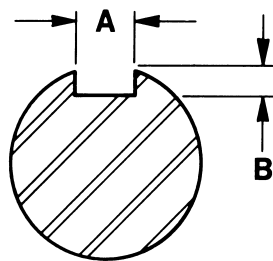

Shaft Diameter	A	B
1	1/4	1/8
1 1/2	3/8	3/16
2	1/2	1/4
2 7/16	5/8	3/16
3	3/4	3/8
3 7/16	7/8	7/16



# Shafts

## Coupling

Conveyor couplings are used to join individual lengths of conveyor screws and allow for rotation within the hanger bearing. Mild steel couplings are normally furnished; however induction hardened bearing area couplings may be furnished where highly abrasive materials are being conveyed. Jig drilling allows for ease of installation.

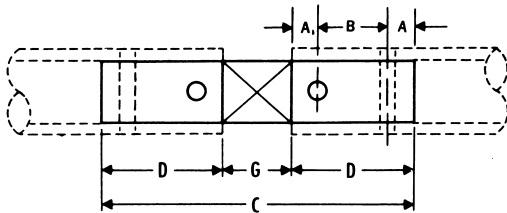

Shaft Diameter	Part Number*	A <sub>1</sub>	A	B	C	D	G	Weight
1	CC2	½	½	2	7½	3	1½	1.5
1½	CC3	¾	¾	3	11½	4¾	2	5.6
2	CC4	¾	¾	3	11½	4¾	2	9.8
2 <sup>7</sup> / <sub>16</sub>	CC5	1 <sup>5</sup> / <sub>16</sub>	1 <sup>5</sup> / <sub>16</sub>	3	12¾	4 <sup>7</sup> / <sub>8</sub>	3	15.4
3	CC6	1	1	3	13	5	3	23.8
3 <sup>7</sup> / <sub>16</sub>	CC7	1½	1¼	4	17½	6¾	4	44.5

\*Add — H for Hardened Shaft.

Shaft is induction hardened in bearing area only to 45-50 RC.

## Close Coupling

Close couplings are used to adjoin conveyor screws where no hanger is required. Jig drilling allows for ease of installation.

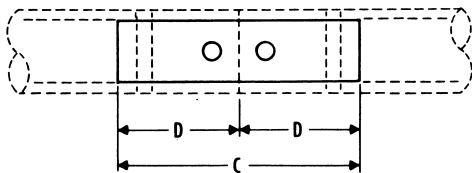

Shaft Diameter	Part Number	C	D	Weight
1	CCC2	6	3	1.3
1½	CCC3	9½	4¾	4.8
2	CCC4	9½	4¾	8.5
2 <sup>7</sup> / <sub>16</sub>	CCC5	9¾	4 <sup>7</sup> / <sub>8</sub>	12.9
3	CCC6	10	5	20.0
3 <sup>7</sup> / <sub>16</sub>	CCC7	13½	6¾	37.0

## Hanger End

Hanger end shafts are designed to connect only one conveyor section to a hanger bearing. These shafts may also be used in pairs to divide an excessively long conveyor assembly between two drives.

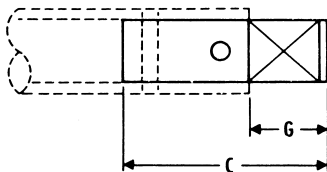

Shaft Diameter	Part Number*	C	G	Weight
1	CHE2	4¾	1¾	1.0
1½	CHE3	6¾	2¾	3.5
2	CHE4	6¾	2¾	6.2
2 <sup>7</sup> / <sub>16</sub>	CHE5	8¾	3¼	10.6
3	CHE6	8¾	3¼	16.5
3 <sup>7</sup> / <sub>16</sub>	CHE7	11¼	4¼	29.7

\*Add — H for Hardened Shaft  
Shaft is induction hardened in bearing area only to 45-50 RC.

CONVEYORS

# End Shaft



End shafts serve only to support the end conveyor section and are therefore usually supplied in cold rolled steel. End shafts are jig drilled for ease of assembly and close diametrical tolerances are held for proper bearing operation.

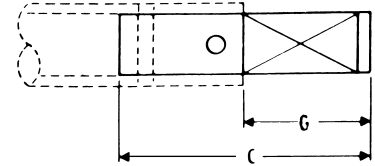

End Shaft Used Without Seal**									
Bronze Bearing					Ball Bearing				
Shaft Diameter	Part Number*	C	G	Weight	Shaft Diameter	Part Number*	C	G	Weight
1	CE2B	6½	3½	1.4	1	CE2BB	6	3	1.2
1½	CE3B	9¼	4½	4.5	1½	CE3BB	8¼	3½	3.8
2	CE4B	10¼	5½	9.0	2	CE4BB	8½	3½	7.5
2⅞	CE5B	11⅞	7	15.4	2⅞	CE5BB	9½	4¼	12.4
3	CE6B	13¾	8½	25.6	3	CE6BB	10½	5½	20.8
3⅞	CE7B	16¾	9¾	42.4	3⅞	CE7BB	13¾	6¾	34.4

\*\*\*Consult Factory

End Shaft Used With Plate or Product Drop Out Seal**									
Bronze Bearing					Ball Bearing				
Shaft Diameter	Part Number*	C	G	Weight	Shaft Diameter	Part Number*	C	G	Weight
1	CE2B-P	7	4	1.5	1	CE2BB-P	6½	3½	1.4
1½	CE3B-P	10¼	5½	5.1	1½	CE3BB-P	9	4¼	4.5
2	CE4B-P	11¼	6½	10.0	2	CE4BB-P	9½	4½	8.3
2⅞	CE5B-P	12¾	8	17.0	2⅞	CE5BB-P	10½	5¼	13.1
3	CE6B-P	13¾	8½	29.8	3	CE6BB-P	11½	6½	23.0
3⅞	CE7B-P	16¾	10½	44.0	3⅞	CE7BB-P	14¾	7¾	37.1

\*\*\*Consult Factory

End Shaft Used With Waste Pack Seal**									
Bronze Bearing					Ball Bearing				
Shaft Diameter	Part Number*	C	G	Weight	Shaft Diameter	Part Number*	C	G	Weight
1	CE2B-W	8	4¼	1.6	1	CE2BB-W	7½	3¾	1.4
1½	CE3B-W	11	6¼	5.2	1½	CE3BB-W	10	5¼	4.8
2	CE4B-W	12	8¼	10.4	2	CE4BB-W	10¾	5½	9.0
2⅞	CE5B-W	13¾	8¾	17.6	2⅞	CE5BB-W	11¾	6½	14.8
3	CE6B-W	14¾	9¾	28.2	3	CE6BB-W	12¾	7¾	24.0
3⅞	CE7B-W	18¾	11¾	48.0	3⅞	CE7BB-W	15¾	8¾	40.2

\*Add - H for Hardened Shaft.

\*\*Shaft length allows for ½ hanger bearing length, clearance between end plate and screw.

\*\*\*Consult Factory

CONVEYORS



# Hangers

<p>Style 226</p>		<p>No. 226 hangers are designed for flush mounting inside the trough permitting dust-tight or weather-proof operation. This type hanger allows for minimum obstruction of material flow in high capacity conveyors. Available with friction type bearing.</p>
<p>Style 216</p>		<p>No. 216 hangers are designed for heavy duty applications. This hanger is flush mounted inside the trough permitting dust tight or weather proof operation. Hard iron or bronze bearings are normally furnished; however, the hanger can be furnished with other bearings.</p>
<p>Style 220</p>		<p>No. 220 hangers are designed for mount on top of the trough flanges and may be used where dust-tight or weather proof operation is not required. This type hanger allows for minimum obstruction of material flow in high capacity conveyors. Available with friction type bearing.</p>
<p>Style 230</p>		<p>No. 230 hangers are designed for heavy duty applications where mounting on top of the trough flanges is required. Hard iron or bronze bearings are normally furnished; however, other bearings are available.</p>
<p>Style 316</p>		<p>No. 316 hangers are designed for heavy duty use in conveyors where abnormal heat requires unequal expansion between the screw and conveyor trough. Hard iron or bronze bearings are normally furnished; however, this hanger can be furnished with other bearings.</p>
<p>Style 326</p>		<p>No. 326 hangers are designed to permit minimum obstruction of material flow and are used in conveyors where abnormal heat requires unequal expansion between the screw and the conveyor trough. Hard iron or bronze bearings are normally furnished, but other type bearings are available.</p>

CONVEYORS

# Hangers



<p>Style 60</p>		<p>No. 60 hangers are furnished with a heavy duty, permanently lubricated and sealed, self aligning ball bearing which permits temperatures up to 245° F. and will allow for up to 4° shaft misalignment. This hanger is mounted on top of the trough flanges. Grease fitting can be furnished if specified.</p>
<p>Style 70</p>		<p>No. 70 hangers are furnished with a heavy duty, permanently lubricated and sealed, self aligning ball bearing which permit temperatures up to 245° F. and will allow for up to 4° shaft misalignment. This hanger is mounted inside the trough. Grease fittings can be furnished if specified.</p>
<p>Style 30</p>		<p>No. 30 hangers are designed for side mounting within the conveyor trough on the noncarrying side and permit a minimum of obstruction of material flow. Available with friction type bearing.</p>
<p>Style 216F</p>		<p>No. 216F hangers are designed for heavy duty applications and are mounted inside of flared trough. Hard iron or bronze bearings are normally furnished; however, other bearings are available.</p>
<p>Style 19B</p>		<p>The No. 19B hanger is similar in construction to the No. 18B except they are mounted on top of the trough angles. Built-in ledges provide supports for the ends of the cover. They are streamline in design and permit free passage of the material. They are regularly furnished with Arguto oil impregnated wood, hard iron, bronze, or other special caps can be furnished.</p>
<p>Air Purged Hanger</p>		<p>Air purged hangers are recommended when handling dusty and abrasive materials which contribute to shutdowns and hanger bearing failures. Air-swept hangers are available for 9"-24" conveyors. They should not be used when handling hot materials (over 250° F) or wet sticky materials or when handling non abrasive materials when an inexpensive hanger will do the job satisfactorily. In service, air-purged hangers deliver relatively trouble-free operation. They help solve noise nuisance problems, and they help reduce power requirement because of the low coefficient of friction. Maximum trough loading should not exceed 15%. The air, at approximately 1-1/4 PSI enters the housing at the top, passes over and around the bearing, and is dissipated around the coupling shaft on both sides of the housing. Thus the bearing is protected from dust and the material in the trough at all times. Only 3 to 7 cu. ft. of air per minute is required to keep each hanger bearing clean.</p>

CONVEYORS



# Hangers

## Style 220

No. 220 hangers are designed for mounting on top of the trough flanges and may be used where dust-tight or weather proof operation is not required. This type hanger allows for minimum obstruction of material flow in high capacity conveyors. Available with friction type bearing.

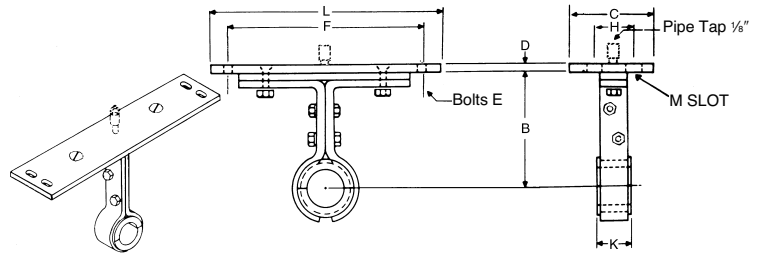

Conveyor Diameter	Coupling Size	Part Number*	B	C	D	E	F	H	K	L	M Slot	Weight Each
4	1	4CH2202	3 <sup>1</sup> / <sub>16</sub>	3 <sup>1</sup> / <sub>2</sub>	<sup>3</sup> / <sub>16</sub>	<sup>1</sup> / <sub>4</sub>	6 <sup>1</sup> / <sub>2</sub>	2	1 <sup>1</sup> / <sub>2</sub>	7 <sup>1</sup> / <sub>4</sub>	<sup>5</sup> / <sub>16</sub> x <sup>3</sup> / <sub>4</sub>	5
6	1 <sup>1</sup> / <sub>2</sub>	6CH2203	4 <sup>1</sup> / <sub>2</sub>	4 <sup>1</sup> / <sub>2</sub>	<sup>3</sup> / <sub>16</sub>	<sup>3</sup> / <sub>8</sub>	8 <sup>3</sup> / <sub>4</sub>	2 <sup>1</sup> / <sub>2</sub>	2	9 <sup>3</sup> / <sub>4</sub>	<sup>7</sup> / <sub>16</sub> x 1 <sup>1</sup> / <sub>16</sub>	7
9	1 <sup>1</sup> / <sub>2</sub>	9CH2203	6 <sup>1</sup> / <sub>8</sub>	4 <sup>1</sup> / <sub>2</sub>	<sup>1</sup> / <sub>4</sub>	<sup>3</sup> / <sub>8</sub>	12 <sup>1</sup> / <sub>4</sub>	2 <sup>1</sup> / <sub>2</sub>	2	13 <sup>1</sup> / <sub>2</sub>	<sup>7</sup> / <sub>16</sub> x 1 <sup>1</sup> / <sub>16</sub>	9
	2	9CH2204	6 <sup>1</sup> / <sub>8</sub>	4 <sup>1</sup> / <sub>2</sub>	<sup>1</sup> / <sub>4</sub>	<sup>3</sup> / <sub>8</sub>	12 <sup>1</sup> / <sub>4</sub>	2 <sup>1</sup> / <sub>2</sub>	2	13 <sup>1</sup> / <sub>2</sub>	<sup>7</sup> / <sub>16</sub> x 1 <sup>1</sup> / <sub>16</sub>	11
10	1 <sup>1</sup> / <sub>2</sub>	10CH2203	6 <sup>3</sup> / <sub>8</sub>	4 <sup>1</sup> / <sub>2</sub>	<sup>1</sup> / <sub>4</sub>	<sup>3</sup> / <sub>8</sub>	13 <sup>3</sup> / <sub>4</sub>	2 <sup>1</sup> / <sub>2</sub>	2	14 <sup>1</sup> / <sub>2</sub>	<sup>7</sup> / <sub>16</sub> x 1 <sup>1</sup> / <sub>16</sub>	10
	2	10CH2204	6 <sup>3</sup> / <sub>8</sub>	4 <sup>1</sup> / <sub>2</sub>	<sup>1</sup> / <sub>4</sub>	<sup>3</sup> / <sub>8</sub>	13 <sup>3</sup> / <sub>4</sub>	2 <sup>1</sup> / <sub>2</sub>	2	14 <sup>1</sup> / <sub>2</sub>	<sup>7</sup> / <sub>16</sub> x 1 <sup>1</sup> / <sub>16</sub>	12
	2 <sup>1</sup> / <sub>16</sub>	2	12CH2204	7 <sup>3</sup> / <sub>4</sub>	5	<sup>3</sup> / <sub>8</sub>	<sup>1</sup> / <sub>2</sub>	15 <sup>3</sup> / <sub>4</sub>	2 <sup>1</sup> / <sub>2</sub>	2	17 <sup>1</sup> / <sub>2</sub>	<sup>9</sup> / <sub>16</sub> x 1 <sup>5</sup> / <sub>16</sub>
3		12CH2205	7 <sup>3</sup> / <sub>4</sub>	5	<sup>3</sup> / <sub>8</sub>	<sup>1</sup> / <sub>2</sub>	15 <sup>3</sup> / <sub>4</sub>	2 <sup>1</sup> / <sub>2</sub>	3	17 <sup>1</sup> / <sub>2</sub>	<sup>9</sup> / <sub>16</sub> x 1 <sup>5</sup> / <sub>16</sub>	21
14	3	12CH2206	7 <sup>3</sup> / <sub>4</sub>	5	<sup>3</sup> / <sub>8</sub>	<sup>1</sup> / <sub>2</sub>	15 <sup>3</sup> / <sub>4</sub>	2 <sup>1</sup> / <sub>2</sub>	3	17 <sup>1</sup> / <sub>2</sub>	<sup>9</sup> / <sub>16</sub> x 1 <sup>5</sup> / <sub>16</sub>	28
	2 <sup>1</sup> / <sub>16</sub>	14CH2205	9 <sup>1</sup> / <sub>4</sub>	5	<sup>1</sup> / <sub>2</sub>	<sup>1</sup> / <sub>2</sub>	17 <sup>1</sup> / <sub>4</sub>	2 <sup>1</sup> / <sub>2</sub>	3	19 <sup>1</sup> / <sub>2</sub>	<sup>9</sup> / <sub>16</sub> x 1 <sup>5</sup> / <sub>16</sub>	26
18	3	14CH2206	9 <sup>1</sup> / <sub>4</sub>	5	<sup>1</sup> / <sub>2</sub>	<sup>1</sup> / <sub>2</sub>	17 <sup>1</sup> / <sub>4</sub>	2 <sup>1</sup> / <sub>2</sub>	3	19 <sup>1</sup> / <sub>2</sub>	<sup>9</sup> / <sub>16</sub> x 1 <sup>5</sup> / <sub>16</sub>	33
	3 <sup>1</sup> / <sub>16</sub>	16CH2206	10 <sup>3</sup> / <sub>8</sub>	5	<sup>1</sup> / <sub>2</sub>	<sup>1</sup> / <sub>2</sub>	19 <sup>1</sup> / <sub>4</sub>	2 <sup>1</sup> / <sub>2</sub>	3	21 <sup>1</sup> / <sub>2</sub>	<sup>9</sup> / <sub>16</sub> x 1 <sup>5</sup> / <sub>16</sub>	39
20	3	18CH2206	12 <sup>1</sup> / <sub>8</sub>	6	<sup>1</sup> / <sub>2</sub>	<sup>5</sup> / <sub>8</sub>	22 <sup>1</sup> / <sub>4</sub>	3 <sup>1</sup> / <sub>2</sub>	3	24 <sup>1</sup> / <sub>2</sub>	1 <sup>1</sup> / <sub>16</sub> x 1 <sup>1</sup> / <sub>16</sub>	41
	3 <sup>1</sup> / <sub>16</sub>	18CH2207	12 <sup>1</sup> / <sub>8</sub>	6	<sup>1</sup> / <sub>2</sub>	<sup>5</sup> / <sub>8</sub>	22 <sup>1</sup> / <sub>4</sub>	3 <sup>1</sup> / <sub>2</sub>	4	24 <sup>1</sup> / <sub>2</sub>	1 <sup>1</sup> / <sub>16</sub> x 1 <sup>1</sup> / <sub>16</sub>	49
24	3	20CH2206	13 <sup>1</sup> / <sub>2</sub>	6	<sup>1</sup> / <sub>2</sub>	<sup>5</sup> / <sub>8</sub>	24 <sup>1</sup> / <sub>4</sub>	3 <sup>1</sup> / <sub>2</sub>	3	26 <sup>1</sup> / <sub>2</sub>	1 <sup>1</sup> / <sub>16</sub> x 1 <sup>1</sup> / <sub>16</sub>	43
	3 <sup>1</sup> / <sub>16</sub>	20CH2207	13 <sup>1</sup> / <sub>2</sub>	6	<sup>1</sup> / <sub>2</sub>	<sup>5</sup> / <sub>8</sub>	24 <sup>1</sup> / <sub>4</sub>	3 <sup>1</sup> / <sub>2</sub>	4	26 <sup>1</sup> / <sub>2</sub>	1 <sup>1</sup> / <sub>16</sub> x 1 <sup>1</sup> / <sub>16</sub>	51
24	3 <sup>1</sup> / <sub>16</sub>	24CH2207	16 <sup>1</sup> / <sub>2</sub>	6	<sup>1</sup> / <sub>2</sub>	<sup>5</sup> / <sub>8</sub>	28 <sup>1</sup> / <sub>4</sub>	3 <sup>1</sup> / <sub>2</sub>	4	30 <sup>1</sup> / <sub>2</sub>	1 <sup>1</sup> / <sub>16</sub> x 1 <sup>1</sup> / <sub>16</sub>	57

\*Refer to Page H-101 for bearings

NOTE: For hangers with oil pipe add -0 to part number

## Style 226

No. 226 hangers are designed for flush mounting inside the trough permitting dust-tight or weather-proof operation. This type hanger allows for minimum obstruction of material flow in high capacity conveyors. Also available with friction type bearing.

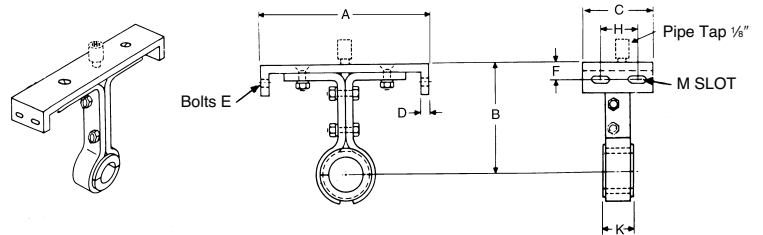

Conveyor Diameter	Coupling Size	Part Number*	A	B	C	D	E	F	H	K	M Slot	Weight Each
4	1	4CH2262	5	3 <sup>3</sup> / <sub>8</sub>	3 <sup>1</sup> / <sub>2</sub>	<sup>3</sup> / <sub>16</sub>	<sup>1</sup> / <sub>4</sub>	1 <sup>1</sup> / <sub>16</sub>	2	1 <sup>1</sup> / <sub>2</sub>	<sup>5</sup> / <sub>16</sub> x <sup>3</sup> / <sub>4</sub>	5
6	1 <sup>1</sup> / <sub>2</sub>	6CH2263	7	4 <sup>1</sup> / <sub>2</sub>	4 <sup>1</sup> / <sub>2</sub>	<sup>3</sup> / <sub>16</sub>	<sup>3</sup> / <sub>8</sub>	<sup>3</sup> / <sub>4</sub>	2 <sup>1</sup> / <sub>2</sub>	2	<sup>7</sup> / <sub>16</sub> x 1 <sup>1</sup> / <sub>16</sub>	7
9	1 <sup>1</sup> / <sub>2</sub>	9CH2263	10	6 <sup>1</sup> / <sub>8</sub>	4 <sup>1</sup> / <sub>2</sub>	<sup>1</sup> / <sub>4</sub>	<sup>3</sup> / <sub>8</sub>	1	2 <sup>1</sup> / <sub>2</sub>	2	<sup>7</sup> / <sub>16</sub> x 1 <sup>1</sup> / <sub>16</sub>	9
	2	9CH2264	10	6 <sup>1</sup> / <sub>8</sub>	4 <sup>1</sup> / <sub>2</sub>	<sup>1</sup> / <sub>4</sub>	<sup>3</sup> / <sub>8</sub>	1	2 <sup>1</sup> / <sub>2</sub>	2	<sup>7</sup> / <sub>16</sub> x 1 <sup>1</sup> / <sub>16</sub>	11
10	1 <sup>1</sup> / <sub>2</sub>	10CH2263	11	6 <sup>3</sup> / <sub>8</sub>	4 <sup>1</sup> / <sub>2</sub>	<sup>1</sup> / <sub>4</sub>	<sup>3</sup> / <sub>8</sub>	1	2 <sup>1</sup> / <sub>2</sub>	2	<sup>7</sup> / <sub>16</sub> x 1 <sup>1</sup> / <sub>16</sub>	10
	2	10CH2264	11	6 <sup>3</sup> / <sub>8</sub>	4 <sup>1</sup> / <sub>2</sub>	<sup>1</sup> / <sub>4</sub>	<sup>3</sup> / <sub>8</sub>	1	2 <sup>1</sup> / <sub>2</sub>	2	<sup>7</sup> / <sub>16</sub> x 1 <sup>1</sup> / <sub>16</sub>	12
	2 <sup>1</sup> / <sub>16</sub>	2	12CH2264	13	7 <sup>3</sup> / <sub>4</sub>	5	<sup>3</sup> / <sub>8</sub>	<sup>1</sup> / <sub>2</sub>	1 <sup>1</sup> / <sub>4</sub>	2 <sup>1</sup> / <sub>2</sub>	2	<sup>9</sup> / <sub>16</sub> x 1 <sup>5</sup> / <sub>16</sub>
3		12CH2265	13	7 <sup>3</sup> / <sub>4</sub>	5	<sup>3</sup> / <sub>8</sub>	<sup>1</sup> / <sub>2</sub>	1 <sup>1</sup> / <sub>4</sub>	2 <sup>1</sup> / <sub>2</sub>	3	<sup>9</sup> / <sub>16</sub> x 1 <sup>5</sup> / <sub>16</sub>	21
14	3	12CH2266	13	7 <sup>3</sup> / <sub>4</sub>	5	<sup>3</sup> / <sub>8</sub>	<sup>1</sup> / <sub>2</sub>	1 <sup>1</sup> / <sub>4</sub>	2 <sup>1</sup> / <sub>2</sub>	3	<sup>9</sup> / <sub>16</sub> x 1 <sup>5</sup> / <sub>16</sub>	28
	2 <sup>1</sup> / <sub>16</sub>	14CH2265	15	9 <sup>1</sup> / <sub>4</sub>	5	<sup>1</sup> / <sub>2</sub>	<sup>1</sup> / <sub>2</sub>	1 <sup>3</sup> / <sub>8</sub>	2 <sup>1</sup> / <sub>2</sub>	3	<sup>9</sup> / <sub>16</sub> x 1 <sup>5</sup> / <sub>16</sub>	26
18	3	14CH2266	15	9 <sup>1</sup> / <sub>4</sub>	5	<sup>1</sup> / <sub>2</sub>	<sup>1</sup> / <sub>2</sub>	1 <sup>3</sup> / <sub>8</sub>	2 <sup>1</sup> / <sub>2</sub>	3	<sup>9</sup> / <sub>16</sub> x 1 <sup>5</sup> / <sub>16</sub>	33
	3 <sup>1</sup> / <sub>16</sub>	16CH2266	17	10 <sup>3</sup> / <sub>8</sub>	5	<sup>1</sup> / <sub>2</sub>	<sup>1</sup> / <sub>2</sub>	1 <sup>3</sup> / <sub>8</sub>	2 <sup>1</sup> / <sub>2</sub>	3	<sup>9</sup> / <sub>16</sub> x 1 <sup>5</sup> / <sub>16</sub>	39
20	3	18CH2266	19	12 <sup>1</sup> / <sub>8</sub>	6	<sup>1</sup> / <sub>2</sub>	<sup>5</sup> / <sub>8</sub>	1 <sup>1</sup> / <sub>2</sub>	3 <sup>1</sup> / <sub>2</sub>	3	1 <sup>1</sup> / <sub>16</sub> x 1 <sup>1</sup> / <sub>16</sub>	41
	3 <sup>1</sup> / <sub>16</sub>	18CH2267	19	12 <sup>1</sup> / <sub>8</sub>	6	<sup>1</sup> / <sub>2</sub>	<sup>5</sup> / <sub>8</sub>	1 <sup>1</sup> / <sub>2</sub>	3 <sup>1</sup> / <sub>2</sub>	4	1 <sup>1</sup> / <sub>16</sub> x 1 <sup>1</sup> / <sub>16</sub>	49
24	3	20CH2266	21	13 <sup>1</sup> / <sub>2</sub>	6	<sup>1</sup> / <sub>2</sub>	<sup>5</sup> / <sub>8</sub>	1 <sup>1</sup> / <sub>2</sub>	3 <sup>1</sup> / <sub>2</sub>	3	1 <sup>1</sup> / <sub>16</sub> x 1 <sup>1</sup> / <sub>16</sub>	43
	3 <sup>1</sup> / <sub>16</sub>	20CH2267	21	13 <sup>1</sup> / <sub>2</sub>	6	<sup>1</sup> / <sub>2</sub>	<sup>5</sup> / <sub>8</sub>	1 <sup>1</sup> / <sub>2</sub>	3 <sup>1</sup> / <sub>2</sub>	4	1 <sup>1</sup> / <sub>16</sub> x 1 <sup>1</sup> / <sub>16</sub>	51
24	3 <sup>1</sup> / <sub>16</sub>	24CH2267	25	16 <sup>1</sup> / <sub>2</sub>	6	<sup>1</sup> / <sub>2</sub>	<sup>5</sup> / <sub>8</sub>	1 <sup>3</sup> / <sub>8</sub>	3 <sup>1</sup> / <sub>2</sub>	4	1 <sup>1</sup> / <sub>16</sub> x 1 <sup>1</sup> / <sub>16</sub>	57

\*Refer to Page H-101 for bearings

\*For hangers with oil pipe add -0 to part number

CONVEYORS

# Hangers



## Style 216

No. 216 hangers are designed for heavy duty applications. This hanger is flush mounted inside the trough permitting dust tight or weather proof operation. Hard iron or bronze bearings are normally furnished; however, the hanger can be furnished with other bearings.

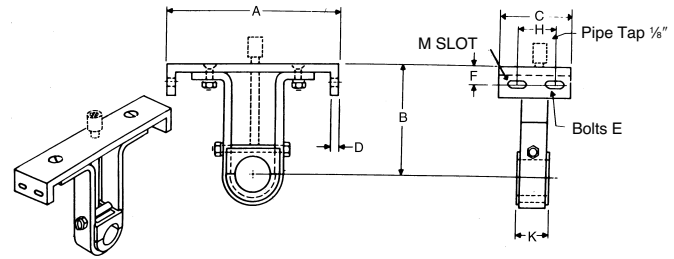

Conveyor Diameter	Coupling Size	Part Number*	A	B	C	D	E	F	H	K	M Slot	Weight Each
6	1½	6CH2163	7	4½	4½	¾	¾	¾	2½	2	7/16 x 1 1/16	5
9	1½	9CH2163	10	6½	4½	¼	¾	1	2½	2	7/16 x 1 1/16	7
	2	9CH2164	10	6½	4½	¼	¾	1	2½	2	7/16 x 1 1/16	9
10	1½	10CH2163	11	6½	4½	¼	¾	1	2½	2	7/16 x 1 1/16	8
	2	10CH2164	11	6½	4½	¼	¾	1	2½	2	7/16 x 1 1/16	10
	2	12CH2164	13	7¾	5	¾	½	1¼	2½	2	¾ x 1 5/16	14
12	2 2/16	12CH2165	13	7¾	5	¾	½	1¼	2½	3	¾ x 1 5/16	18
	3	12CH2166	13	7¾	5	¾	½	1¼	2½	3	¾ x 1 5/16	21
	2 2/16	14CH2165	15	9¼	5	½	½	1¾	2½	3	¾ x 1 5/16	23
14	3	14CH2166	15	9¼	5	½	½	1¾	2½	3	¾ x 1 5/16	25
	3	16CH2166	17	10¾	5	½	½	1¾	2½	3	¾ x 1 5/16	28
18	3	18CH2166	19	12¾	6	½	¾	1½	3½	3	1 1/16 x 1 11/16	34
	3 7/16	18CH2167	19	12¾	6	½	¾	1½	3½	4	1 1/16 x 1 11/16	44
20	3	20CH2166	21	13½	6	½	¾	1½	3½	3	1 1/16 x 1 11/16	36
	3 7/16	20CH2167	21	13½	6	½	¾	1½	3½	4	1 1/16 x 1 11/16	47
24	3 7/16	24CH2167	25	16½	6	¾	¾	1¾	3½	4	1 1/16 x 1 11/16	53

\*Refer to Page H-101 for bearings

\*For hangers with oil pipe add -0 to part number

## Style 230

No. 230 hangers are designed for heavy duty applications where mounting on top of the trough flange is required. Hard iron or bronze bearings are normally furnished; however, other bearings are available.

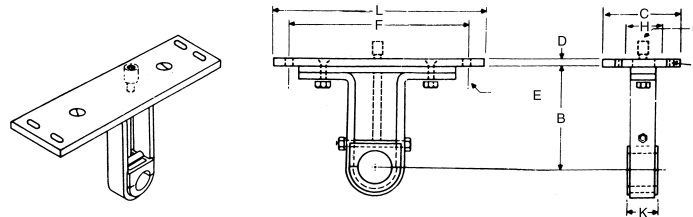

Conveyor Diameter	Coupling Size	Part Number*	B	C	D	E	F	H	K	L	M Slot	Weight Each
6	1½	6CH2303	4½	4½	¼	¾	8¾	2½	2	9¾	7/16 x 1 1/16	6
9	1½	9CH2303	6½	4½	¼	¾	12¼	2½	2	13½	7/16 x 1 1/16	8
	2	9CH2304	6½	4½	¼	¾	12¼	2½	2	13½	7/16 x 1 1/16	10
10	1½	10CH2303	6½	4½	¼	¾	13¾	2½	2	14½	7/16 x 1 1/16	9
	2	10CH2304	6½	4½	¼	¾	13¾	2½	2	14½	7/16 x 1 1/16	11
12	2	12CH2304	7¾	5	¾	½	15¾	2½	2	17½	¾ x 1 5/16	15
	2 2/16	12CH2305	7¾	5	¾	½	15¾	2½	3	17½	¾ x 1 5/16	20
	3	12CH2306	7¾	5	¾	½	15¾	2½	3	17½	¾ x 1 5/16	25
14	2 2/16	14CH2305	9¼	5	¾	½	17¾	2½	3	19½	¾ x 1 5/16	24
	3	14CH2306	9¼	5	¾	½	17¾	2½	3	19½	¾ x 1 5/16	29
16	3	16CH2306	10¾	5	¾	½	19¾	2½	3	21½	¾ x 1 5/16	35
	3	18CH2306	12¾	6	½	¾	22¼	3½	3	24½	1 1/16 x 1 11/16	34
18	3 7/16	18CH2307	12¾	6	½	¾	22¼	3½	4	24½	1 1/16 x 1 11/16	47
	3	20CH2306	13½	6	½	¾	24¼	3½	3	26½	1 1/16 x 1 11/16	40
20	3 7/16	20CH2307	13½	6	½	¾	24¼	3½	4	26½	1 1/16 x 1 11/16	49
	3 7/16	24CH2307	16½	6	¾	¾	28¼	3¾	4	30½	1 1/16 x 1 11/16	55

\*Refer to Page H-101 for bearings

\*For hangers with oil pipe add -0 to part number





# Hangers

## Style 316

No. 316 hangers are designed for heavy duty use in conveyors where abnormal heat requires unequal expansion between the screw and conveyor trough. Hard iron or bronze bearings are normally used; however, this hanger can be furnished with other bearings.

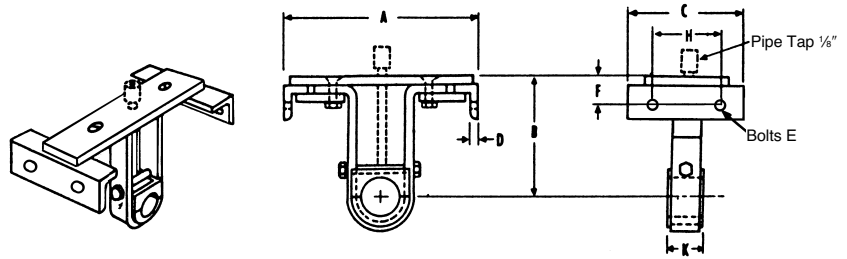

## Style 326

No. 326 hangers are designed to permit minimum obstruction of material flow and are used in conveyors where abnormal heat requires unequal expansion between the screw and the conveyor trough. Hard iron or bronze bearings are normally used, but other type bearings are available.

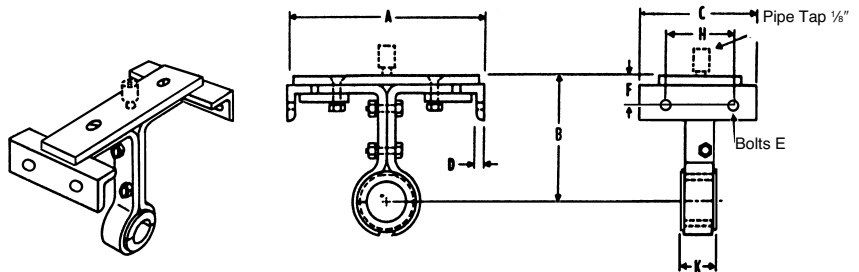

Conveyor Diameter	Coupling Size	Part Number		A	B	C	D	E	F	H	K
		Style 316*	Style 326*								
6	1 1/2	6CH3163	6CH3263	7	4 1/2	6	3/16	3/8	3/4	4 1/2	2
9	1 1/2	9CH3163	9CH3263	10	6 1/4	6	3/16	3/8	1	4 1/2	2
	2	9CH3164	9CH3264	10	6 1/8	6	3/16	3/8	1	4 1/2	2
10	1 1/2	10CH3163	10CH3263	11	6 3/8	6	3/16	3/8	1	4 1/2	2
	2	10CH3164	10CH3264	11	6 3/8	6	3/16	3/8	1	4 1/2	2
12	2	12CH3164	12CH3264	13	7 3/4	6 1/2	1/4	1/2	1 1/4	5	2
	2 7/16	12CH3165	12CH3265	13	7 3/4	6 1/2	1/4	1/2	1 1/4	5	3
	3	12CH3166	12CH3266	13	7 3/4	6 1/2	1/4	1/2	1 1/4	5	3
14	2 7/16	14CH3165	14CH3265	15	9 1/4	6 3/4	1/4	1/2	1 3/8	5	3
	3	14CH3166	14CH3266	15	9 1/4	6 3/4	1/4	1/2	1 3/8	5	3
16	3	16CH3166	16CH3266	17	10 3/8	6 3/4	1/4	1/2	1 3/8	5	3
	3 7/16	18CH3166	18CH3266	19	12 1/8	6 3/4	1/4	3/8	1 3/8	5 1/4	3
18	3 7/16	18CH3167	18CH3267	19	12 1/8	7	1/4	3/8	1 3/8	5 1/4	4
	3	20CH3166	20CH3266	21	13 1/2	7	1/4	3/8	1 3/8	5 1/4	3
20	3 7/16	20CH3167	20CH3267	21	13 1/2	7	1/4	3/8	1 3/8	5 1/4	4
	3 7/16	24CH3167	24CH3267	25	16 1/2	7	1/4	3/8	1 3/8	5 1/4	4

\*Refer to Page H-101 for bearings

\*For hangers with oil pipe add -0 to part number

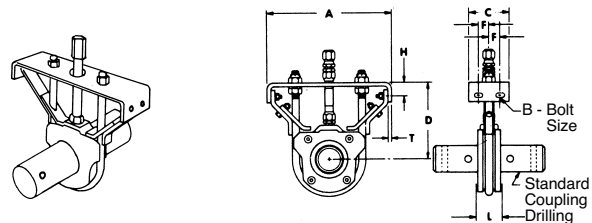

## Air Purged Hanger

Air purged hangers are recommended when handling dusty and abrasive materials which contribute to shut-downs and hanger bearing failures. They should not be used when handling hot materials (over 250°F) or wet sticky materials or when handling nonabrasive materials when an inexpensive hanger will do the job satisfactorily. Maximum trough loading should not exceed 15%. The air, at approximately 1 1/4 PSI, enters the housing at the top, passes over and around the bearing, and is dissipated around the coupling shaft on both sides of the housing. Only 3 to 7 cu. ft. of air per minute is required to keep each hanger bearing clean.

Screw Diameter	Part Number	Shaft Dia.	Weight Each	A	B	C	D	F	H	L	T
9	9CHAPH3	1 1/2	15	10	3/8	4 1/2	6 3/8	1 1/4	1	2	1/4
	9CHAPH4	2	20		3/8						
12	12CHAPH4	2	30	13	1/2	5	7 1/4	1 1/4	1 1/4	2	1/4
	12CHAPH5	2 7/16	52							3	
	12CHAPH6	3	68							3	
14	14CHAPH5	2 7/16	60	15	1/2	5	9 1/4	1 1/4	1 3/8	3	3/8
	14CHAPH6	3	74								
16	16CHAPH6	3	77	17	1/2	5	10 3/8	1 1/4	1 3/8	3	1/8
18	18CHAPH6	3	91	19	3/8	6	12 1/8	1 1/4	1 3/8	3	1/2
20	20CHAPH6	3	105	21	3/8	6	13 1/2	1 1/4	1 3/8	3	1/2
	20CHAPH7	3 7/16	140							4	
24	24CHAPH7	3 7/16	155	25	3/8	6	16 1/2	1 1/4	1 3/8	4	1/2

Space required on coupling for hanger. Air supply should be clean and dry.

Dimensions in inches. Weight in pounds.

CONVEYORS

# Hangers



## Style 30

No. 30 hangers are designed for side mounting within the conveyor trough on the non-carrying side and permit a minimum of obstruction of material flow. Available with friction type bearing.

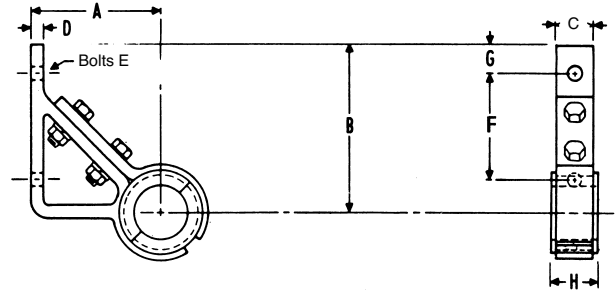
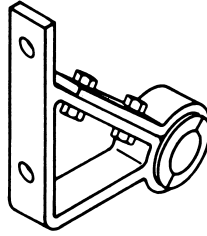

Conveyor Diameter	Coupling Diameter	Part Number*	A	B	C	D	E	F	G	H	Weight Each
6	1½	6CH303	3½	4¼	1½	¾	⅝	3¾	½	2	3
9	1½	9CH303	5	5½	1½	¾	¾	4¼	½	2	6
	2	9CH304	5	5½	1½	½	¾	4¼	½	2	8
10	1½	10CH303	5½	6¾	1½	¾	½	4¾	¾	2	8
	2	10CH304	5½	6¾	1½	½	½	4¾	¾	2	9
12	2	12CH304	6½	7½	1½	½	½	5½	¾	2	12
	2⅞	12CH305	6½	7½	2	½	½	5½	¾	3	18
	3	12CH306	6½	7½	2	½	½	5½	¾	3	20
14	2⅞	14CH305	7½	9	2	½	¾	6¾	¾	3	20
	3	14CH306	7½	9	2	½	¾	6¾	¾	3	22
16	3	16CH306	8½	10¾	2	¾	¾	8	1	3	32
18	3	18CH306	9½	11¾	2	¾	¾	9	1¼	3	30
	3⅞	18CH307	9½	11¾	3	¾	¾	9	1¼	4	33
20	3	20CH306	10½	13¼	2	¾	¾	10¼	1¼	3	32
	3⅞	20CH307	10½	13¼	3	¾	¾	10¼	1¼	4	38
24	3⅞	24CH307	12½	16¼	3	¾	¾	12¾	1½	4	46

\*Refer to Page H-101 for bearings

NOTE: For hangers with oil pipe add -0 to part number

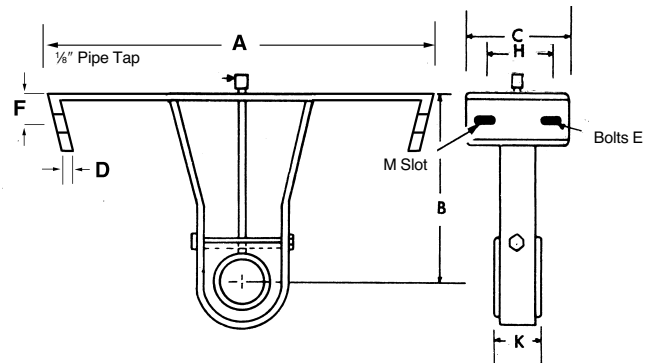
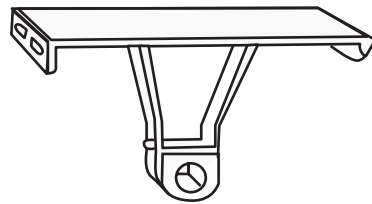

## Style 216F

No. 216F hangers are designed for heavy duty applications and are mounted inside of flared trough. Hard iron or bronze bearings are normally furnished; however, other bearings are available.

Conveyor Diameter	Coupling Diameter	Part Number*	A	B	C	D	E	F	H	K	Weight Each	M Slot
6	1½	6CH216F3	14	7	4	¾	¾	¾	2½	2	9	⅞ x ¼
9	1½	9CH216F3	18	9	4	¾	¾	¾	2½	2	14	⅞ x ¼
	2	9CH216F4	18	9	4	¾	¾	¾	2½	2	17	⅞ x ¼
12	2	12CH216F4	22	10	5	¾	½	1¾	2½	2	24	⅞ x ¼
	2⅞	12CH216F5	22	10	5	¾	½	1¾	2½	3	28	⅞ x ¼
	3	12CH216F6	22	10	5	¾	½	1¾	2½	3	32	⅞ x ¼
14	2⅞	14CH216F5	24	11	5	¾	½	1¾	2½	3	31	⅞ x ¼
	3	14CH216F6	24	11	5	¾	½	1¾	2½	3	34	⅞ x ¼
16	3	16CH216F6	28	11½	5	¾	½	1¾	2½	3	38	⅞ x ¼
	3⅞	16CH216F7	28	11½	5	¾	½	1¾	2½	4	52	1⅞ x ⅞
18	3	18CH216F6	31	12¾	5	½	¾	1½	3½	3	61	1⅞ x ⅞
	3⅞	18CH216F7	31	12¾	5	½	¾	1½	3½	4	64	1⅞ x ⅞
20	3	20CH216F6	34	13½	5	½	¾	1½	3½	3	55	1⅞ x ⅞
	3⅞	20CH216F7	34	13½	5	½	¾	1½	3½	4	64	1⅞ x ⅞
24	3⅞	24CH216F7	40	16½	5	½	¾	1½	3½	4	71	1⅞ x ⅞

\*Refer to Page H-101 for bearings

NOTE: For hangers with oil pipe add -0 to part number

H-98



# Hangers

## Style 60

No. 60 hangers are furnished with a heavy duty, permanently lubricated and sealed, self-aligning ball bearing which permits temperatures up to 245° F. and will allow for up to 4° shaft misalignment. This hanger is mounted on top of the trough flanges. Grease fitting can be furnished if specified.

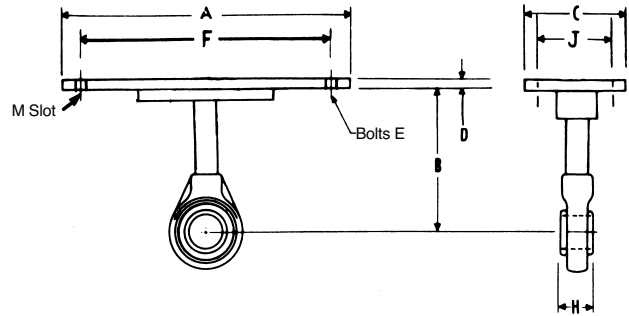
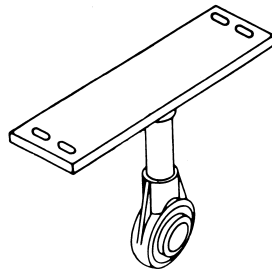

Conveyor Diameter	Coupling Size	Part Number*	A	B	C	D	E	F	H	J	Weight Each	M Slot
6	1½	6CH603	9¾	4½	4	¾	¾	8¾	1¼	2	7	¾ x 1¼
9	1½	9CH603	13½	6½	4	¼	¾	12¼	1¼	2	8	¾ x 1¼
	2	9CH604	13½	6½	4	¼	¾	12¼	1¼	2	9	¾ x 1¼
10	1½	10CH603	14½	6¾	4	¼	¾	13¼	1¼	2	9	¾ x 1¼
	2	10CH604	14½	6¾	4	¼	¾	13¼	1¼	2	10	¾ x 1¼
12	2	12CH604	17½	7¼	5	¾	½	15½	1¼	2½	12	¾ x 1¼
	2½	12CH605	17½	7¼	5	¾	½	15½	1¾	2½	20	¾ x 1¼
	3	12CH606	17½	7¼	5	¾	½	15½	2¼	2½	30	¾ x 1¼
14	2½	14CH605	19½	9¼	5	½	½	17¾	1¾	2½	21	¾ x 1¼
	3	14CH606	19½	9¼	5	½	½	17¾	2¼	2½	32	¾ x 1¼
16	3	16CH606	21½	10¾	5	½	½	19¾	2¼	2½	35	¾ x 1¼
18	3	18CH606	24½	12¾	6	½	¾	22¼	2¼	3½	40	¾ x 1¼
20	3	20CH606	26½	13¾	6	½	¾	24¼	2¼	3½	45	¾ x 1¼
24	3½	24CH607	30½	16½	6	¾	¾	28¼	2¾	3¾	58	¾ x 1¼

\*For hangers with oil pipe add -0 to part number

## Style 70

No. 70 hangers are furnished with a heavy duty, permanently lubricated and sealed, self-aligning ball bearing which permits temperatures up to 245° F. and will allow for up to 4° shaft misalignment. This hanger is mounted inside the trough. Grease fitting can be furnished if specified.

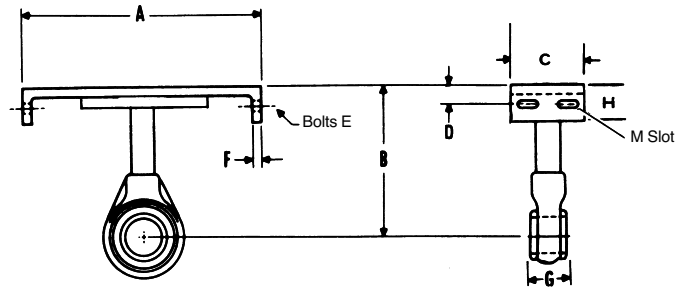

Conveyor Diameter	Coupling Size	Part Number*	A	B	C	D	E	F	G	H	Weight Each	M Slot
6	1½	6CH703	7	4½	4½	¾	¾	¾	1¼	1½	7	¾ x 1¼
9	1½	9CH703	10	6½	4½	1	¾	¼	1¼	1¾	8	¾ x 1¼
	2	9CH704	10	6½	4½	1	¾	¼	1¾	1¾	9	¾ x 1¼
10	1½	10CH703	11	6¾	4½	1	¾	¼	1¼	1¾	9	¾ x 1¼
	2	10CH704	11	6¾	4½	1	¾	¼	1¾	1¾	10	¾ x 1¼
12	2	12CH704	13	7¼	5	1¼	½	¾	1¼	2½	12	¾ x 1¼
	2½	12CH705	13	7¼	5	1¼	½	¾	1¾	2½	20	¾ x 1¼
	3	12CH706	13	7¼	5	1¼	½	¾	2¼	2½	30	¾ x 1¼
14	2½	14CH705	15	9¼	5	1¾	½	½	1¾	2¼	21	¾ x 1¼
	3	14CH706	15	9¼	5	1¾	½	½	2¼	2¼	32	¾ x 1¼
16	3	16CH706	17	10¾	5	1¾	½	½	2¼	2¼	35	¾ x 1¼
18	3	18CH706	19	12¾	6	1½	¾	½	2¼	2½	40	¾ x 1¼
20	3	20CH706	21	13¾	6	1½	¾	½	2¼	2½	45	¾ x 1¼
24	3½	24CH707	25	16½	6	1¾	¾	¾	2¾	2¾	58	¾ x 1¼

\*For hangers with oil pipe add -0 to part number

CONVEYORS

# Hangers



## Style 18B

The No. 18-B Hanger has streamlined cast iron frame and bearing cap held in place by a U-bolt. It is mounted inside the trough below the cover. Holes are located for bolting through the top angle of the conveyor trough. This hanger is regularly furnished with Babbitt bearings. Arguto oil impregnated wood, hard iron, bronze, or other special caps can be furnished.

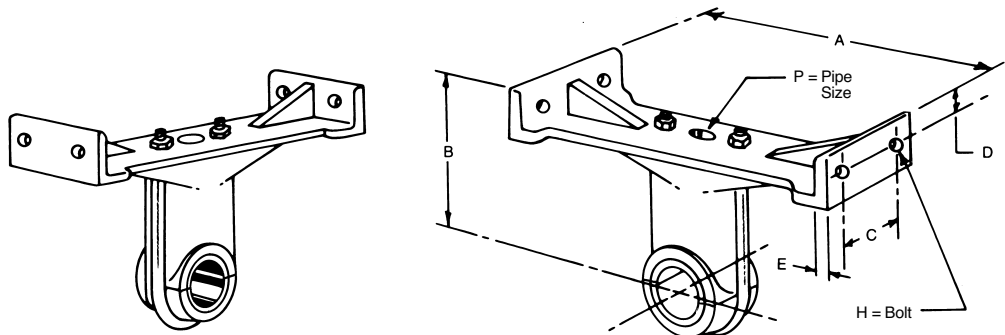

Conveyor Diameter	Bearing Bore	Thru Bore	Part Number	Weight	A	B	C	D	E	H Bolt	P
6	1½	2	6CH18B3	5	7	4¾	1⅞	¾	⅞	¾	⅞
9	1½	2	9CH18B3	9	10	6	2⅞	¾	¾	¾	⅞
			9CH18B4	—	10	6	2⅞	¾	¾	¾	⅞
10 OBSOLETE	1½	2	10CH18B3	11	11	6¼	2⅞	¾	¾	¾	⅞
			10CH18B4	—	11	6¼	2⅞	¾	¾	¾	⅞
12	2	2	12CH18B4	15	13	7⅞	2⅞	1	½	½	⅞
			12CH18B5	29	13	7⅞	2⅞	1	½	½	⅞
			12CH18B6	—	13	7⅞	2⅞	1	½	½	⅞
14	2⅞	3	14CH18B5	25	15	9⅞	2¼	1	¾	½	⅞
			14CH18B6	27	15	9⅞	2¼	1	¾	½	⅞
16	3	3	16CH18B6	30	17	10½	2¼	1	¾	½	⅞
18	3	3	18CH18B6	35	19	12	3	1¼	¾	½	⅞

\*\*Consult Factory

## Style 19B

The No. 19-B Hanger is similar in construction to the No. 18-B except they are mounted on top of the trough instead of below. Built-in ledges provide supports for the ends of the cover. They are streamlined in design and permit free passage of the material.

They are regularly furnished with Bronze bearings, Arguto oil impregnated wood, hard iron, bronze, or other special caps can be furnished.

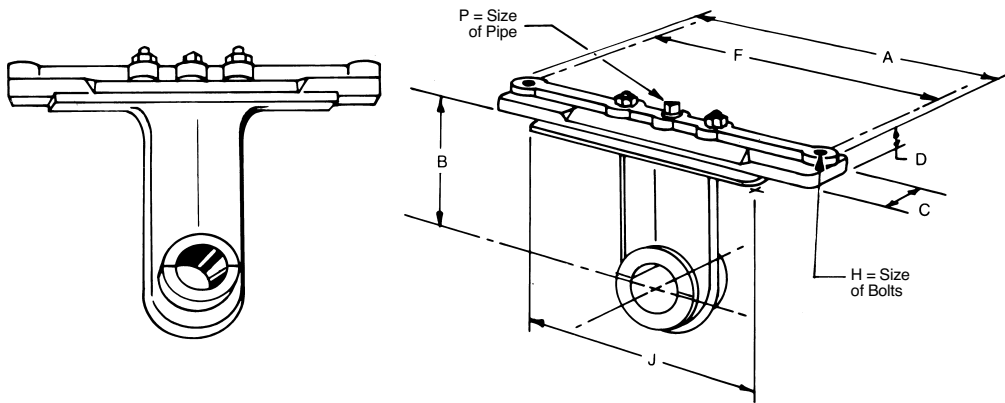

Conveyor Diameter	Bearing Bore	Part Number	Weight	A	B	C	D	F	H Bolt	J	P Pipe
6	1½	6CH19B3	8.5	9⅞	4½	1⅞	¾	8¾	½	6½	¼
9	1½	9CH19B3	13	13½	6⅞	1¼	1	12¼	½	9½	¼
		9CH19B4	15.5	13½	6⅞	1¼	1	12¼	½	9½	¼
10	1½	10CH19B3	14	14½	6⅞	1¼	1	13¼	½	10½	¼
		10CH19B4	—	14½	6⅞	1¼	1	13¼	½	10½	¼
12	2	12CH19B4	24	17	7⅞	2	1¼	15¾	½	12½	¼
		12CH19B5	24.5	17	7⅞	2¼	1½	15¾	½	12½	¼
		12CH19B6	—	17	7⅞	2¼	1½	15¾	½	12½	¼
14	2⅞	14CH19B5	37	19¼	9¼	2¼	1¼	17¾	½	14½	¼
		14CH19B6	—	19¼	9¼	2¼	1¼	17¾	½	14¼	¼
16	2⅞	16CH19B5	45	21¼	10⅞	3	1¼	19¾	¾	16½	¼
		16CH19B6	—	21¼	10⅞	3	1¼	19¾	¾	16½	¼
18	3	18CH19B6	48.5	23¼	12⅞	3	1¼	22¼	¾	18½	¼
20	3⅞	20CH19B7	60.0	26¼	13½	4	1⅞	24¼	¾	20	¼

CONVEYORS



## Screw Conveyor Hanger Bearing Selection Application

BEARING MATERIAL	MAXIMUM OPERATING TEMP (°F)	STYLES AVAILABLE	MATERIAL FDA APPROVED	SELF LUBE	SOME SUGGESTED USES	COMMENTS
<i>Martin</i> HARD IRON	500°	220		Yes	Chemical, Cement, Aggregate	Requires Hardened shafts.
CAST HARD IRON	500°	220, 216, 19B			Lime, Cement, Salt, Gypsum	Requires hardened shaft. Can be noisy. Lubrication required in some applications.
WOOD	160°	220, 216, 19B		Yes	Grain, Feed, Fertilizer	Good general purpose.
<i>Martin</i> BRONZE	850°	220		Yes	Grain, Feed, Processing	High quality bearings. High load capacity.
NYLON	250°	220	Yes	Yes	Food and Grain	For dry applications.
NYLATRON	250°	220, 19B		Yes	Chemical, Handling, Grain, Feed	Very low load capacity.
UHMW	225°	220, 216	Yes	Yes	Food	Material USDA approved. Does not swell in water.
STELLITE	1000°	220, 216			Chemical, Cement, Aggregate	Requires Stellite insert in shaft.
INDUSTRIAL GRADE ENGINEERED NYLON	160°	220		Yes	Grain, Feed, Fertilizer	Economical replacement for wood.
WHITE MELAMINE	250°	220	Yes		Food Industry	Recommended for sugar.
FOOD GRADE ENGINEERED NYLON	300°	220	Yes	Yes	Food, Grain, Fertilizer	For dry application.
BALL BEARING	180°	60, 70			Non-abrasive applications	General purpose use.
<i>Martin</i> HDPE	200°	220	Yes	Yes	Grain, Feed, Chemical Handling	Recommended for non-abrasive applications.
CERAMIC <sup>1</sup>	1,000°	220, 216	Yes		Chemical, Cement, Food	Requires Hardened shafts.
<i>Martin</i> URETHANE	200°	220		Yes	Grain, Chemical, Fertilizer	Good general purpose.

CONVEYORS

<sup>1</sup> Higher temperature ceramics are available.

# Hanger Bearings



Hanger Type	Bore	Part Number	Bearing
216	1½	CHB2163*	
	2	CHB2164*	
230	2⅞	CHB2165*	
	3	CHB2166*	
316	3⅞	CHB2167*	

\*H—Hard Iron \*W—Wood \*O—Oil Hole Top Cap \*BR—Bronze \*U—UHMW \*G—Gatke \*C—Ceramic \*St—Stellite \*UR - Urethane

Hanger Type	Bore	Part Number	Bearing
220	1½	CHB2203*	
	2	CHB2204*	
226	2⅞	CHB2205*	
326	3	CHB2206*	
30	3⅞	CHB2207*	

BR — Bronze \*H — Cast Hard Iron \*W — Wood \*N — Nylatron \*P — UDPE  
 MHI — *Martin* Hard iron (oil impregnated) \*MCB — Melamine \*C — Ceramic \*WN — White Nylon  
 \*MBR — *Martin* Bronze (oil impregnated) \*U — UHMW \*UR — Urethane

CONVEYORS

Hanger Type	Bore	Part Number	Bearing
60 Ball Bearing	1½	CHB603	
	2	CHB604	
70 Ball Bearing	2⅞	CHB605	
	3	CHB606	
	3⅞	CHB607	

Note: New style bearings are available with slinger shield one side.

Hanger Type	Bore	Part Number	Bearing
18B	1½	CHB18B3*	
	2	CHB18B4*	
	2⅞	CHB18B5*	
19B	3	CHB18B6*	
	3⅞	CHB18B7*	

\*W—Wood \*H—Hard Iron \*N—Nylatron \*BR—Bronze \*G—Gatke

Note: Furnished as bottom cap only



# Trough Covers

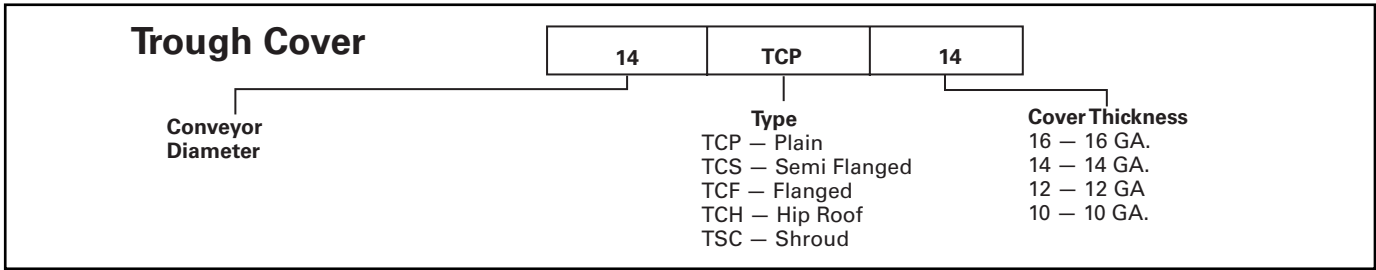

It is the responsibility of the contractor, installer, owner and user to install, maintain and operate the conveyor components and conveyor assemblies manufactured and supplied by *Martin* in such a manner as to comply with the Williams-Steiger Occupational Safety and Health Act and with all state and local laws and ordinances and the American National Standard Institute Safety Code.

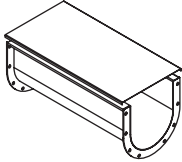
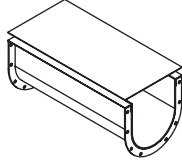
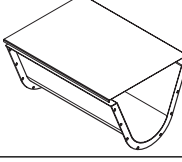
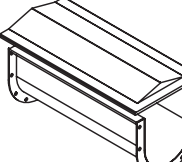
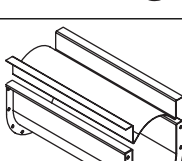
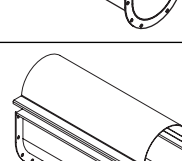
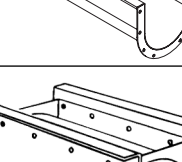
Flanged Covers		Most commonly used. Can be supplied with gaskets and butt straps for dust tight applications. Semi-flanged must be furnished if spring clamps are used.
Flat Covers		Usually used only to cover conveyor for safety.
Flared Trough Covers		Usually flanged type and heavier gauges because of span.
Hip Roof Covers		Hip roof covers are similar to conventional flanged covers except they are peaked slightly to form a ridge along the center of the cover. A welded end plate closes the peaked section at each end of the trough while intermediate joints are usually buttstrap connected. Hip roof covers are usually recommended for outdoor installations to prevent accumulation of moisture. They are also often used in applications where a more rigid cover is required.
Shroud Covers		Used to approximate tubular cross section for inclined or feeder applications.
Domed Covers		Domed covers are half circle domes rolled to the same inside diameter as the trough bottom and are flanged for bolting to the trough top rails. They are used where venting of fumes or heat from the material being conveyed is required. End sections have a welded end plate and intermediate joints are buttstrap connected. Vent pipes or suction lines can be attached to the cover.
Feeder Shrouds		Shrouds are used in trough sections of screw feeders to decrease the clearance between the cover and feeder screw to obtain proper feed regulation. Lengths are sufficient to prevent flushing of the majority of materials being handled and gauges are proportioned to trough size and gauge.

CONVEYORS



# Trough Cover

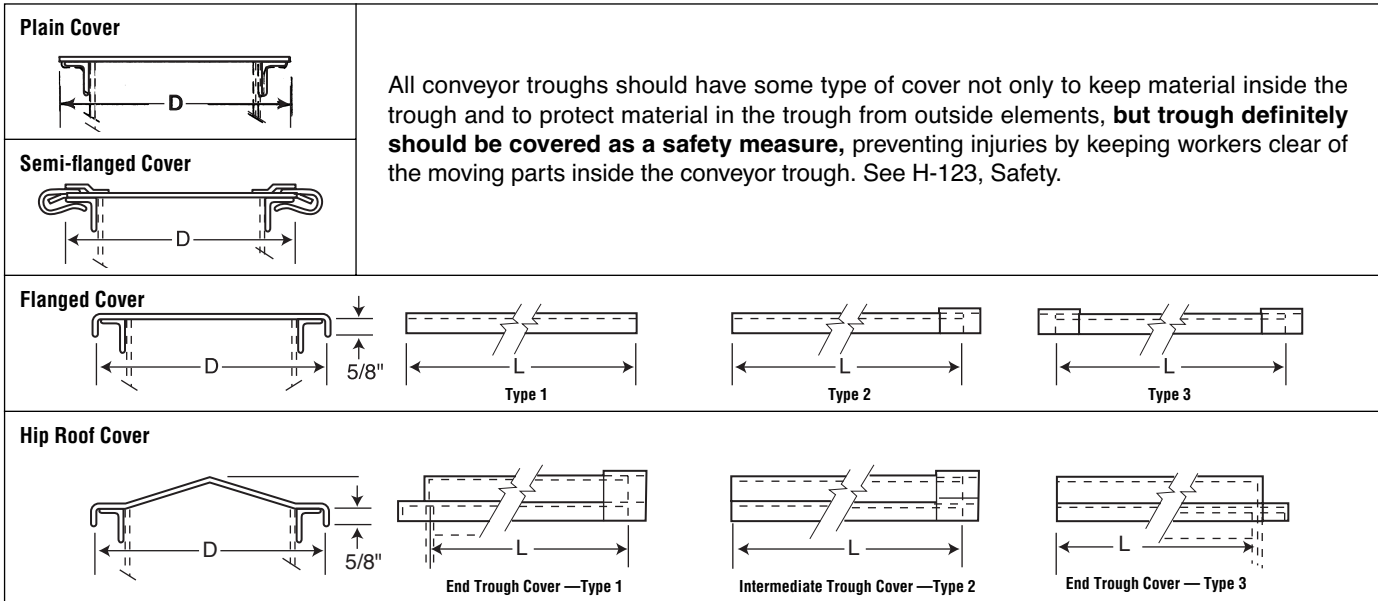

Conveyor Diameter	Plain Cover				Plain Semi-Flanged Cover				Flanged Cover				Hip Roof Cover			
	Part Number	Thick-ness Ga.	Wt. Per Ft.	D	Part Number	Thick-ness Ga.	Wt. Per Ft.	D	Part Number	Thick-ness Ga.	Wt. Per Ft.	D	Part Number	Thick-ness Ga.	Wt. Per Ft.	D
4 *	4TCP16	16	1.5	8	4TCS16 4TCS14	16 14	2.1 2.6	7 $\frac{1}{4}$	4TCF16 4TCF14	16 14	1.9 2.4	8 $\frac{3}{8}$	4TCH16 4TCH14	16 14	2.0 2.5	8 $\frac{3}{8}$
6 *	6TCP16	16	2.0	9 $\frac{1}{4}$	6TCS16 6TCS14	16 14	2.3 3.8	9 $\frac{1}{4}$	6TCF16 6TCF14	16 14	2.1 2.6	10 $\frac{1}{8}$	6TCH16 6TCH14	16 14	2.3 2.8	10 $\frac{1}{8}$
9 *	9TCP14	14	3.5	13 $\frac{1}{8}$	9TCS14 9TCS12 9TCS10	14 12 10	4.1 5.7 7.3	13 $\frac{1}{8}$	9TCF16 9TCF14 9TCF12 9TCF10	16 14 12 10	3.2 3.9 5.5 7.1	14	9TCH16 9TCH14	16 14	3.3 4.1	14
10 *	10TCP14	14	3.8	14 $\frac{1}{8}$	10TCS14 10TCS12 10TCS10	14 12 10	4.4 6.1 7.8	14 $\frac{1}{8}$	10TCF16 10TCF14 10TCF12 10TCF10	16 14 12 10	3.4 4.2 5.9 7.6	15	10TCH16 10TCH14	16 14	3.5 4.3	15
12 **	12TCP14	14	4.6	17 $\frac{1}{2}$	12TCS14 12TCS12 12TCS10	14 12 10	5.1 7.1 9.0	17 $\frac{1}{2}$	12TCF14 12TCF12 12TCF10	14 12 10	4.9 6.9 8.8	18	12TCH14 12TCH12	14 12	5.0 7.1	18
14 **	14TCP14	14	5.1	19 $\frac{1}{8}$	14TCS14 14TCS12 14TCS10	14 12 10	5.6 7.8 9.9	19 $\frac{1}{8}$	14TCF14 14TCF12 14TCF10	14 12 10	5.4 7.6 9.7	19 $\frac{1}{8}$	14TCH14 14TCH12	14 12	5.5 7.7	19 $\frac{1}{8}$
16 **	16TCP14	14	5.6	21 $\frac{1}{2}$	16TCS14 16TCS12 16TCS10	14 12 10	6.1 8.5 10.8	21 $\frac{1}{2}$	16TCF14 16TCF12 16TCF10	14 12 10	5.9 8.3 10.6	21 $\frac{1}{2}$	16TCH14 16TCH12	14 12	6.1 8.5	21 $\frac{1}{2}$
18 **	18TCP12	12	8.9	24 $\frac{1}{2}$	18TCS12 18TCS10	12 10	9.6 12.3	24 $\frac{1}{2}$	18TCF14 18TCF12 18TCF10	14 12 10	6.7 9.4 12.1	25	18TCH14 18TCH12	14 12	6.8 9.5	25
20 **	20TCP12	12	9.7	26 $\frac{1}{2}$	20TCS12 20TCS10	12 10	10.3 13.3	26 $\frac{1}{2}$	20TCF14 20TCF12 20TCF10	14 12 10	7.2 10.1 13.1	27	20TCH14 20TCH12	14 12	7.4 10.4	27
24 **	24TCP12	12	11.1	30 $\frac{1}{2}$	24TCS12 24TCS10	12 10	11.8 15.1	30 $\frac{1}{2}$	24TCF14 24TCF12 24TCF10	14 12 10	8.3 11.6 14.9	31	24TCH14 24TCH12	14 12	8.4 11.8	31

For average applications where dust confinement is not a problem, 2'-0" centers or 10 fasteners per 10'-0" section are generally satisfactory. For commercially dust tight 1'-0" centers or 20 fasteners per 10'-0" section are suggested.

\*L — Standard lengths are 5'-0" & 10'-0"

\*\*L — Standard lengths are 5', 6', 10' & 12'-0"

□ — Standard gauge

CONVEYORS





# Cover Accessories

## Flanged Conveyor Inlets

The two styles of flanged conveyor inlets are designed for either bolting or welding to flat or flanged conveyor trough cover. The inlet size and bolt arrangement is the same as the standard conveyor discharge spout.

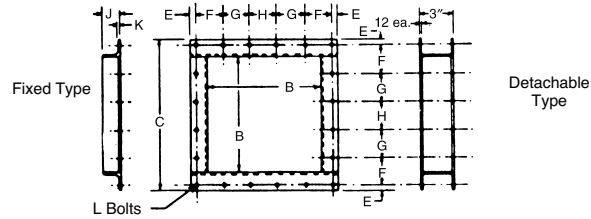

Conveyor Diameter	Part Number		Weight	B	C		E		F	G	H	J	K	L
	Fixed Inlet	Detachable Inlet			Fixed Inlet	Detachable Inlet	Fixed Inlet	Detachable Inlet						
4	4CIF	4CID	1.8	5	7½	7½	¾	¾	2¼	—	2¼	1¼	⅛	¼
6	6CIF	6CID	5.0	7	10	10	1⅛	1⅛	2⅞	—	3	1½	⅜	¾
9	9CIF	9CID	6.8	10	13	13	½	½	4	—	4	1½	⅜	¾
10	10CIF	10CID	7.4	11	14	14¼	½	½	4⅞	—	4⅞	1½	⅜	¾
12	12CIF	12CID	12.1	13	17	17¼	¾	¾	5½	—	5¼	2	⅜	¾
14	14CIF	14CID	13.7	15	19	19¼	¾	¾	3½	3½	3½	2	⅜	¾
16	16CIF	16CID	15.8	17	21	21¼	¾	¾	3¾	4	4	2	⅜	¾
18	18CIF	18CID	29.0	19	24	24¼	1	1½	4⅞	4¾	4¾	2½	⅜	½
20	20CIF	20CID	31.8	21	26	26¼	1	1½	4⅞	4¾	4¾	2½	⅜	½
24	24CIF	24CID	37.2	25	30	30¼	1	1½	5	5	5½	2½	⅜	½

## Spring Clamps

Spring Clamps are used to attach plain and semi-flanged covers to trough. These clamps are normally riveted to the trough flange and will pivot to allow removal of cover.

Spring Clamp

Clamp No.	A	B	C	D	E	F	G	H	J	Wt.
SPC—1	⅝	⅝	¼	1¼	1¾	1½	3	1	⅝	.38

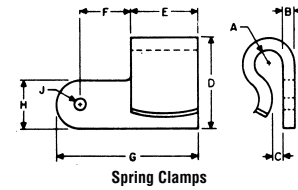

## Spring Clamps with Cover Bracket

Spring Clamps with cover brackets are designed to attach to the top side of semi-flanged and plain covers.

Spring Clamp with Cover Bracket

Clamp No.	A	B	C	D	E	F	G	H	J	Wt.
SPCA—1	1⅛	¾	⅝	1¼	1¾	¾	¾	¾	1¼	.50

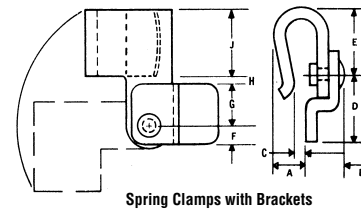

## Screw Clamps

Screw Clamps are a simple and effective means of attaching flanged or flat covers to trough. Screw Clamps available in mild steel, stainless steel and zinc plated.

Screw Clamp

Clamp No.	A	B	C	D	E	F	G	Wt.
CSC—2	2¼	1	1⅞	1¼	¾	¾	¾	.42

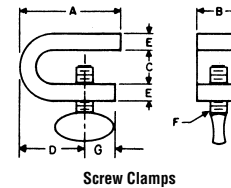

## Cover Gaskets

	Red Rubber	Sponge Rubber	White Rubber
Conv. Dia.	Size	Size	Size
4.6	RR125• ⅝ X 1¼	SP75• ⅝ X ¾	WN125• ⅝ X 1¼
9, 10	RR150• ⅝ X 1½	SP100• ⅝ X 1	WN150• ⅝ X 1½
12, 14, 16	RR200• ⅝ X 2	SP150• ⅝ X 1½	WN250• ⅝ X 2
18, 20, 24	RR250• ⅝ X 2½	SP200• ⅝ X 2	WN250• ⅝ X 2½

## Toggle Clamps

Quick acting toggle clamps are used to attach covers for quick accessibility. Normally this type clamp is attached by welding the front or top of clamp to the trough and can be adjusted to fit all sizes of trough, while allowing 90° to clear working area.

Conveyor	Part Number	No. Required per 10' Section	A	B	C	D	E	F	G
4—24	QTC	6 to 8	7⅞	2⅞	1⅞	2	1¼	⅝	⅝

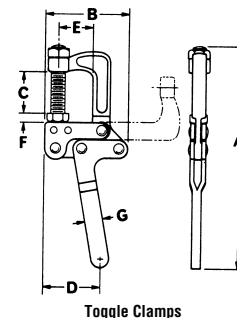

CONVEYORS

# Feeder Shrouds



## Feeder Shrouds

Shrouds are used in trough sections of screw feeders to decrease the clearance between the cover and feeder screw to obtain proper feed regulation. Lengths are sufficient to prevent flushing of the majority of materials being handled and gauges are proportioned to trough size and gauge.

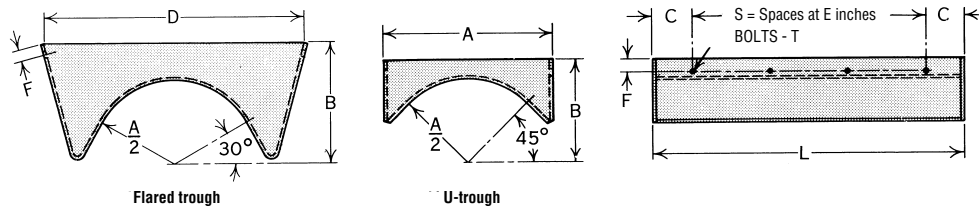

Screw Diameter Inches	Part No.		Shroud Thickness	A	B		C	D	E	F		L	T	S
	U	Flared			U	Flared				U	Flared			
4	4TFS14	4FFS14	14 Ga.	5	3 3/8	—	2	—	4	3/8	—	8	1/4	1
6	6TFS14	6FFS14	14 Ga.	7	4 1/2	7	3	14	6	3/4	3/4	12	5/16	1
	6TFS12	6FFS12	12 Ga.	7	4 1/2	7	3	14	6	3/4	3/4	12	5/16	1
9	9TFS14	9FFS14	14 Ga.	10	6 3/8	9	3	18	6	7/8	3/4	18	3/8	2
	9TFS7	9FFS7	3/16"	10	6 3/8	9	3	18	6	7/8	3/4	18	3/8	2
10	10TFS14	10FFS14	14 Ga.	11	6 3/8	—	2 1/2	—	5	7/8	—	20	3/8	3
	10TFS7	10FFS7	3/16"	11	6 3/8	—	2 1/2	—	5	7/8	—	20	3/8	3
12	12TFS12	12FFS12	12 Ga.	13	7 3/8	10	3	22	6	1 1/8	1	24	3/8	3
	12TFS7	12FFS7	3/16"	13	7 3/8	10	3	22	6	1 1/8	1	24	3/8	3
14	14TFS12	14FFS12	12 Ga.	15	9 3/8	11	3 1/2	24	7	1 1/8	1	28	3/8	3
	14TFS7	14FFS7	3/16"	15	9 3/8	11	3 1/2	24	7	1 1/8	1	28	3/8	3
16	16TFS12	16FFS12	12 Ga.	17	10 3/8	11 1/2	4	28	8	1 1/8	1	32	3/8	3
	16TFS7	16FFS7	3/16"	17	10 3/8	11 1/2	4	28	8	1 1/8	1	32	3/8	3
18	18TFS12	18FFS12	12 Ga.	19	12 3/8	12 3/8	4 1/2	31	9	1 1/8	1 1/8	36	3/8	3
	18TFS7	18FFS7	3/16"	19	12 3/8	12 3/8	4 1/2	31	9	1 1/8	1 1/8	36	3/8	3
20	20TFS10	20FFS10	10 Ga.	21	13 3/8	13 3/8	4	34	8	1 1/8	1 1/8	40	3/8	4
	20TFS7	20FFS7	3/16"	21	13 3/8	13 3/8	4	34	8	1 1/8	1 1/8	40	3/8	4
24	24TFS10	24FFS10	10 Ga.	25	16 1/2	16 1/2	4	40	8	1 1/8	1 1/8	48	3/8	5
	24TFS7	24FFS7	3/16"	25	16 1/2	16 1/2	4	40	8	1 1/8	1 1/8	48	3/8	5

CONVEYORS



# Conveyor Shrouds

## Conveyor Shrouds

Conveyor shroud covers are used to form a tubular cross section within the conveyor trough. This arrangement gives the features of a tubular housing while allowing removal of the shroud for easy access and cleaning. Flat or flanged covers can be used over the shroud cover when it is objectionable for the recess in the shroud to be exposed to dust or weather. Various types of shrouds are furnished to fit various applications. These types are described below.

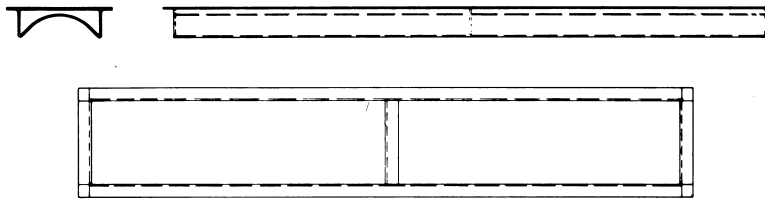

**Type 1**

Type 1 Shroud cover has flanged sides over top rail and flanged ends at both ends. This type is used when shroud is full length of trough or between hangers.

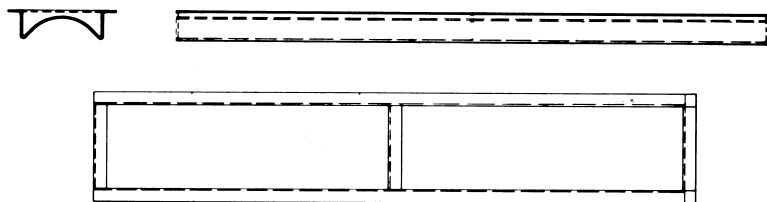

**Type 2**

Type 2 Shroud cover has flanged sides over top rails and flanged ends on one end over trough end; other end is plain. This type shroud is used at an inlet opening or next to a hanger at the plain end.

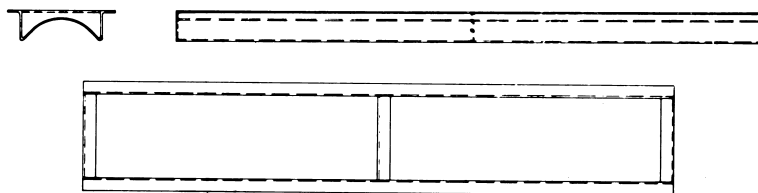

**Type 3**

Type 3 Shroud cover has flanged sides over top rail and both ends closed and no flanges over ends. This type shroud is used between hangers.

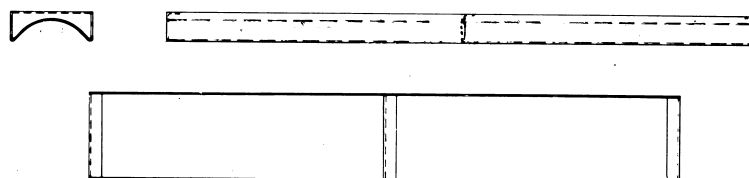

**Type 4**

Type 4 Shroud cover has no flanges at sides or ends. Bolt holes are provided along sides, for bolting through side of trough. This allows flush mounting with top of trough and a cover may be used over the shroud. This shroud is used mostly for short lengths when installed ahead of an inlet opening.

# Special Features



## SECTION IV

### SPECIAL FEATURES SECTION IV

Covers.....	H-109
Trough Ends.....	H-110
Trough.....	H-111
Conveyor Screws .....	H-114
Discharges.....	H-119
Inlets .....	H-120

### Special Features

The information presented in this section gives descriptions and functions of the most commonly used special features available in the design of conveyor systems.

These special features will greatly broaden the range of uses for screw conveyor when added to the many standard features available. Standard features and components are always more desirable and practical in the design of a screw conveyor system; however, one or more of these special features may sometimes be required in special applications for a workable or more efficient system.

*Martin*

## Covers

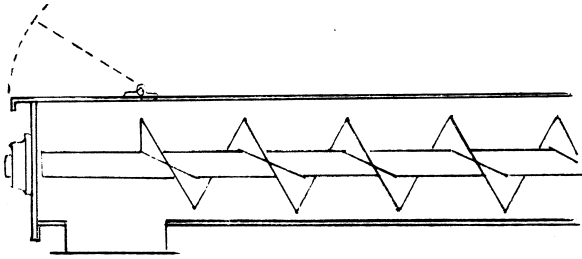

OVERFLOW COVER sections are used as a safety relief to handle overflow over the discharge in cases where the discharge may become plugged. It is a short section of flanged or flat cover hinged across the width to the adjoining cover. The cover is not attached to the trough in order that it can be raised by pressure from within the trough.

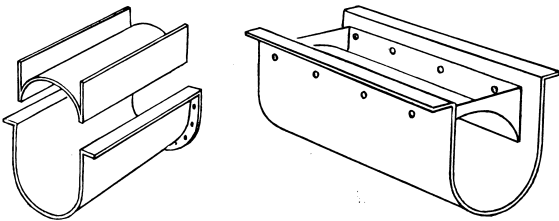

SHROUD COVERS are designed to fit inside a standard conveyor or trough of a Screw Feeder or inclined conveyor, and create a tubular trough effect. This cover has an advantage over tubular trough in that ease of access is combined with the convenience of using standard hangers and accessories. An additional flat cover may be required over the shroud to prevent accumulation of dust or water in the recessed portion of the shroud cover.

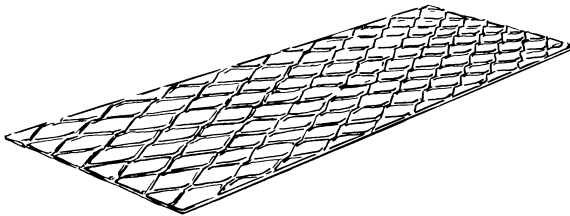

EXPANDED METAL COVERS can be furnished where cover is required for safety but constant visual inspection is required. STANDARD COVERS of any design can be furnished in heavier gauges, when needed to support weight.

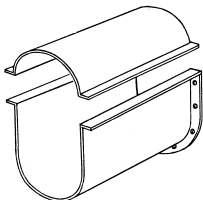

DOMES COVERS are half circle domes rolled to the same inside diameter as the trough bottom and are flanged for bolting to the trough top rails. They are used where venting of fumes or heat from the material being conveyed is required. End sections have a welded end plate and intermediate joints are buttstrap connected. Vent pipes or suction lines can be attached to the cover.

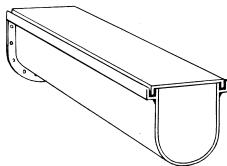

DUST SEAL COVERS are flanged down on all four sides to match channel sections fabricated on the sides, ends, and cross channels of special dust seal troughs. The length of the cover should not exceed one-half the length of the trough section.

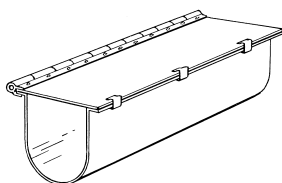

HINGED COVERS may be constructed from conventional flat covers or most special covers. They are equipped with a hinge on one side for attaching to the trough and are bolted or clamped to the trough on the other side. Hinged covers are used in applications where it is not desirable to have a loose cover, such as in high areas above walkways where the cover might fall.

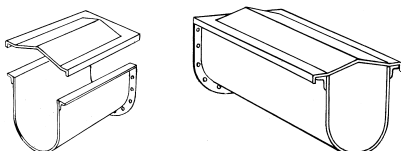

HIP ROOF COVERS are similar to conventional flanged covers except they are peaked slightly to form a ridge along the center of the cover. A welded end plate closes the peaked section at each end of the trough while intermediate joints are usually buttstrap connected. Hip roof covers are usually recommended for outdoor installations to prevent accumulation of moisture. They are also often used in applications where a more rigid cover is required.

## Trough Ends

*Martin*

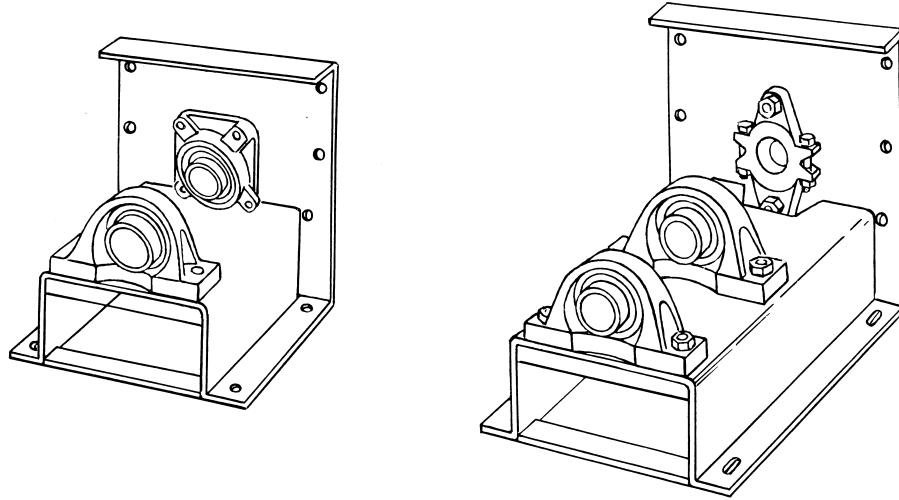

SHELF-TYPE TROUGH ENDS are furnished with outboard bearing pedestals for mounting pillow block bearings. The bearings are mounted away from the trough end plate allowing ample room to protect the bearing when handling abrasive or hot materials. This arrangement allows the use of most any type shaft seal desired. Either one or two bearings can be used.

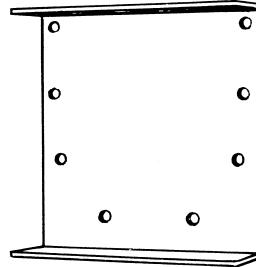
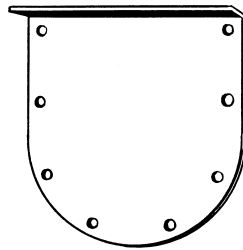

BLIND TROUGH ENDS are used on the tail end (normally the inlet end) of a conveyor, when sealing the end shaft is extremely difficult. A hanger is used inside the trough to support the tail shaft without the shaft projecting through the trough end.

A blind trough end plate can also be furnished with a dead shaft welded to the end plate. For this type the screw is bushed with an antifricition bearing to carry the radial load of the screw. When required, a grease fitting can be furnished through the dead shaft for lubricating the bearing.



# Trough

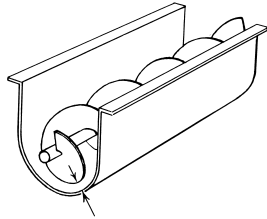

**WIDE CLEARANCE TROUGH** is of conventional construction except with a wider clearance between the outside of the conveyor screw and the inside of the trough. This type trough is used when it is desirable to form a layer of conveyed material in the trough. The material thus moves on itself, protecting the trough from undue wear. By using a wide clearance or oversize trough, a greater capacity than using a standard conveyor screw can be obtained for some materials that travel as a mass. When wide clearance trough is required, it is more economical to use a standard conveyor screw and the next larger size standard trough.

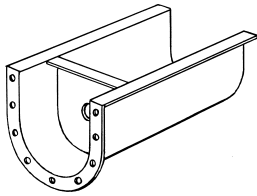

**BULK HEAD** is a plate or baffle shaped to the contour of the inside of the trough and is normally welded or bolted six to twelve inches from the trough end. The bulk head protects the end bearing and drive unit from heat while handling hot materials, when the pocket formed is filled with packing or insulation. The bulk head can be used in the same manner to prevent damage to seals and bearings when handling extremely abrasive materials.

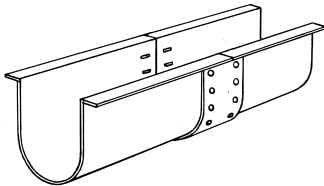

**EXPANSION JOINT** is a connection within a length of trough to allow for expansion caused by hot materials being conveyed. The expansion joint is constructed with bolts fastened in slots to allow for expansion or with a telescoping type slip joint. The number of joints and amount of expansion will depend on the application.

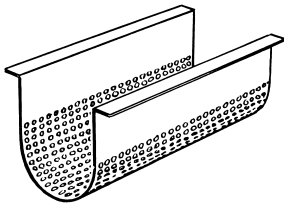

**PERFORATED BOTTOM TROUGH** is equipped with a perforated bottom, and is used as a screening operation or drain section when liquids are present in the conveyed material. The size of the perforations in the trough will vary depending on the material and application.

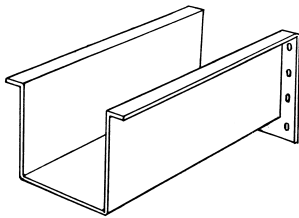

**RECTANGULAR TROUGH** is made with a flat bottom and can be formed from a single sheet or with sides and bottom of separate pieces. This type trough is frequently used in handling abrasive materials capable of forming a layer of material on the bottom of the trough. The material thus moves on itself, protecting the trough from undue wear. Also in handling hot materials, the material will form its own internal insulation with this type trough.

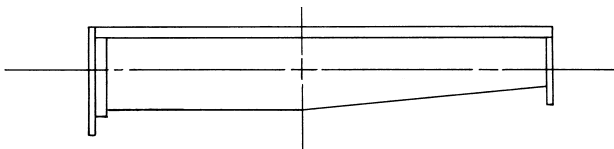

**TAPERED BOTTOM TROUGH** is used to prevent a dead space in the trough at the small end of a tapered conveyor screw. With some materials the tapered trough is necessary to prevent bridging in the trough, or contamination of the material.

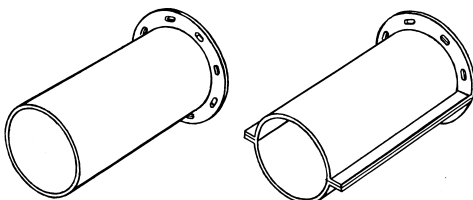

**TUBULAR TROUGH** is furnished in either solid tube construction or split tube construction with flanges for bolting or clamping the two halves together. This trough is a complete tube enclosure and is used for weather-tight applications, for loading to full cross sections, and for inclined or vertical applications where fall back necessitates the housing to operate at a full loading.

\*Conveyors shown without cover for illustration purposes only. Please follow manufacturing safety guidelines when operating conveyors.

# Trough

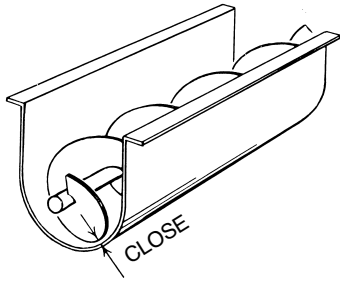

**CLOSE CLEARANCE TROUGH** is of conventional construction except with a closer clearance between the outside of the conveyor screw and the inside of the trough. This type trough leaves less material in the trough and is often used when a greater clean-out of conveyed material is required. This type trough also minimizes fall back of certain materials in an inclined conveyor.

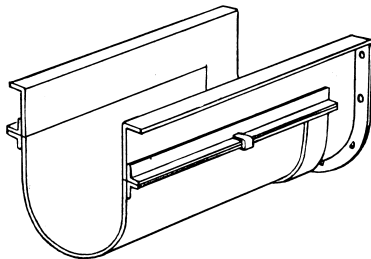

**DROP BOTTOM TROUGH** is equipped with either a bolted or clamped and completely removable drop bottom, or hinged on one side with bolts or clamps on the opposite side. This design offers ease in cleaning of the trough and screw conveyor, and is often used when handling food products where internal inspection and cleaning of the screw conveyor is necessary.

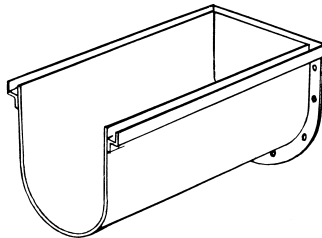

**DUST SEAL TROUGH** (Sometimes referred to as **SAND SEAL TROUGH**) has Z-bar top flanges and formed channel cross members making a continuous channel pocket around the top of the trough into which a special flanged cover is set. The channel is filled with sand or dust of the product being conveyed, thus creating an effective seal against the escape of dust from within the conveyor.

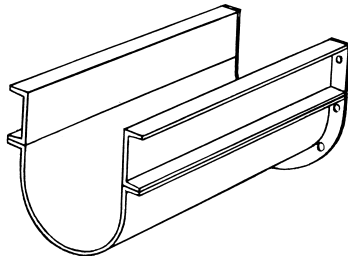

**CHANNEL SIDE TROUGH** is made with separate detachable trough bottoms, bolted or clamped to formed or rolled steel channels. The channels may be of any reasonable length to span widely spaced supports. This type of trough is occasionally used for easy replacement of trough bottoms, and to facilitate repairs when conveyor screw and hangers are not accessible from the top. The channel side trough can also be used without a bottom for filling bins and hoppers.

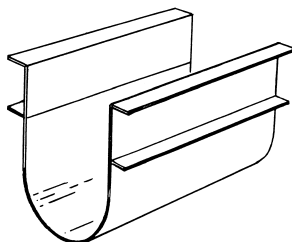

**HIGH SIDE TROUGH** is of conventional construction except that the trough sides extend higher than standard from the center line to the top of the trough. This type trough is frequently used in conveying materials which mat together and travel as a mass on top of the conveyor screw. High side trough will confine this type material in the trough, but still affords the necessary expansion room.

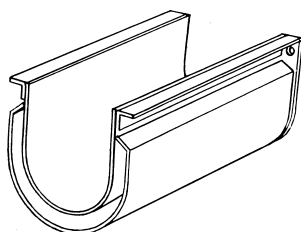

**JACKETED TROUGH** consists of a formed jacket continuously welded to the trough. This type trough is widely used for heating, drying or cooling of materials. Pipe connections are provided for supply and discharge of the heating or cooling media. Special construction must be provided for higher pressures.

CONVEYORS





# Trough

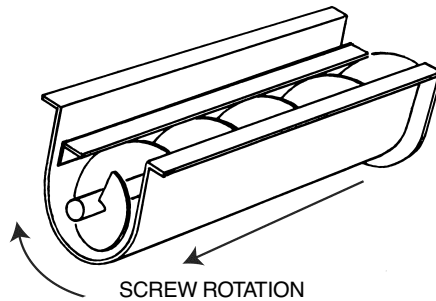

**HOLD DOWN ANGLES** are used to hold the conveyor screw in the trough when the conveyor is operated without intermediate hangers or when chunks of material may tend to ride under the conveyor screw and push it up. The angle is constructed of formed or regular angle iron and is attached to one side of the full length of trough far enough above the conveyor screw to allow approximately one-half inch clearance between the bottom angle and the conveyor screw.

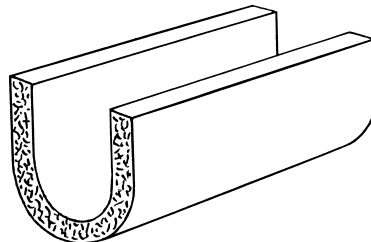

**INSULATED CONVEYOR TROUGH** is used when handling hot or cold materials. There are many types of insulation materials and arrangements that can be used.

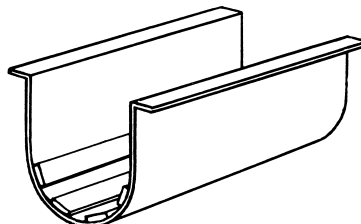

**RIDER BARS** are flat bars one to one and one-half inches in width running part of length or full length of the trough. Two or four bars are normally used and are spaced an equal distance apart along the curved bottom of the trough. The bars are used to support the conveyor screw to prevent wear on the trough when internal hanger bearings are not used. Rider bars are sometimes referred to as Rifling Bars when they are used to assist in conveying materials that tend to stick to the conveyor screw and rotate with it.

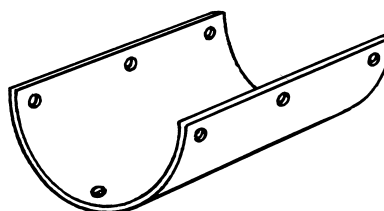

**SADDLE TYPE WEAR PLATES** are plates curved to the contour of the inside of the trough and of slightly less thickness than the clearance between the conveyor screw and trough. The plates are made in lengths of approximately one and one-half times the pitch of the conveyor screw and are normally spaced at intervals equal to the distance between hangers. They are used to support the conveyor screw to prevent damage to the trough when internal hanger bearings are not used.

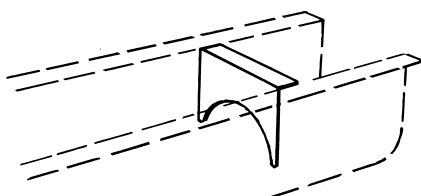

**STRIKE OFF PLATE (Shroud Baffle)** is a single plate bolted vertically to the upper portion of the trough and is cut out to the contour of the screw. This plate is used to regulate the flow of material from an inlet by preventing flooding across the top of the conveyor screw.

\*Conveyors shown without cover for illustration purposes only. Please follow manufacturing safety guidelines when operating conveyors.

# Conveyor Screws

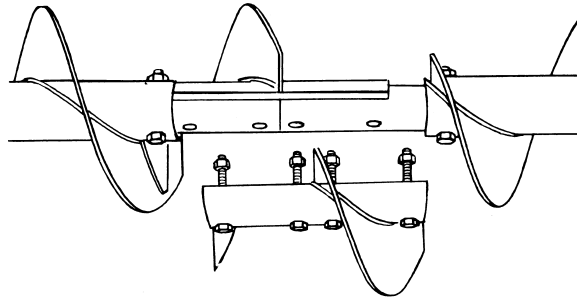

SPLIT FLIGHT COUPLINGS permit installation or removal of individual sections of conveyor screw without disturbing adjoining sections. When they are installed on both sides of each hanger, sections of screw can be removed without disturbing the hangers. These must be furnished complete with matching shafts.

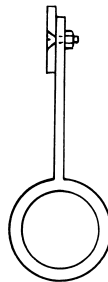

WEAR FLIGHTS, or wearing shoes, attached with countersunk bolts to the carrying side of conveyor screw flights are used for handling highly abrasive materials and are easily replaceable.

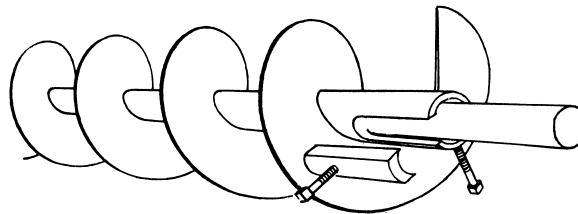

QUICK DETACHABLE KEY CONVEYOR SCREW is designed for easy removal from the conveyor trough. Each section of screw is provided with a removable key located at one end of the pipe. By removing this key, a conveyor screw section and coupling with a hanger can be quickly removed without disturbing other components.

## Width of Application Chart

Screw Diameter	Standard Width of Application
6	1
9	1½
12	2
14	2
16	2½
18	2½
20	3
24	3

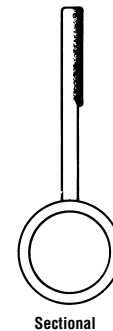
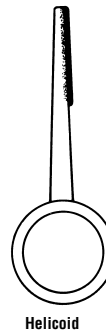

NOTE: Weld-on type normally 1/16" thick.

HARD SURFACED FLIGHTS sometimes called abrasive resistant conveyors can be furnished using one of many hardsurfacing processes. The hard surfaced area is normally an outer portion of the face of the flight on the carrying side of the conveyor screw. This process is applied to the conveyor screw to resist wear when handling highly abrasive materials.

*Martin*

## Conveyor Screws

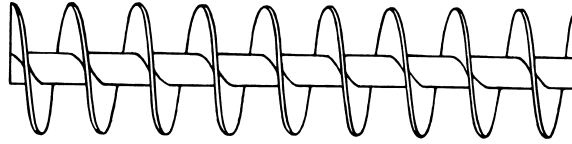

SHORT PITCH CONVEYOR SCREWS are of regular construction except that the pitch of the flights is reduced. They are recommended for use in inclined conveyors of 20 degrees slope and over, and are extensively used as feeder screws, and for controlling cross sectional loading in the balance of a conveyor when short pitch is used at the inlet opening.

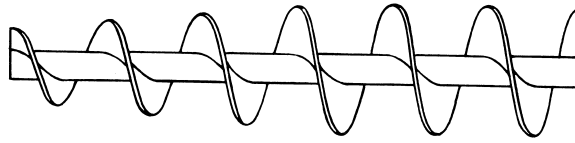

TAPERING FLIGHT CONVEYOR SCREWS are frequently used as feeder screws for handling friable lumpy material from bins or hoppers and also to draw the material uniformly from the entire length of the feed opening.

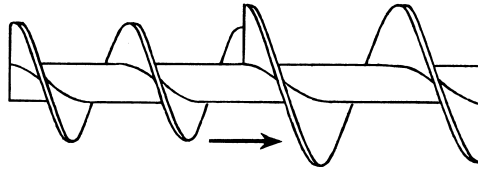

STEPPED DIAMETER CONVEYOR SCREWS consist of flights of different diameters, each with its regular pitch, mounted in tandem on one pipe or shaft. They are frequently used as feeder screws, with the smaller diameter located under bins or hoppers to regulate the flow of material.

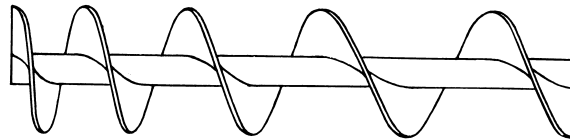

STEPPED PITCH CONVEYOR SCREWS are screws with succeeding single or groups of flights increasing in pitch and are used as feeder screws to draw free-flowing materials uniformly from the entire length of the feed opening.



CONE SCREW to withdraw material evenly from a hopper or bin. Constant pitch reduces bridging. Requires less start-up horsepower.

## Conveyor Screws

*Martin*

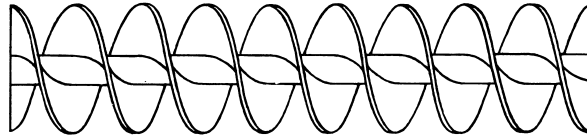

DOUBLE FLIGHT CONVEYOR SCREWS of regular pitch promote a smooth gentle flow and discharge of certain materials. Double flight can be used at hanger points only, for smooth flow past hangers.

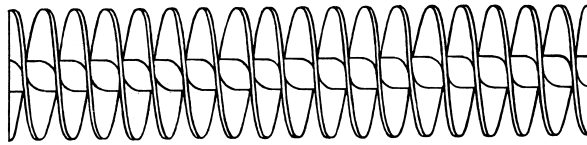

DOUBLE FLIGHT SHORT PITCH CONVEYOR SCREWS assure more accurate regulation of feed and flow in screw feeders and effectively deter flushing action of fluid materials.

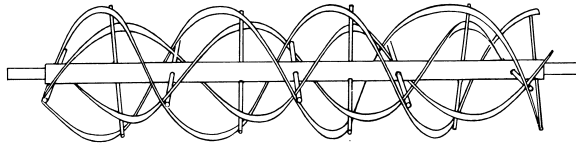

MULTIPLE RIBBON FLIGHT CONVEYOR SCREWS. This type of screw consists of two or more ribbon flights of different diameters and opposite hand, mounted one within the other on the same pipe or shaft by rigid supporting lugs. Material is moved forward by one flight and backward by the other, thereby inducing positive and thorough mixing. (Made per customer specifications.)

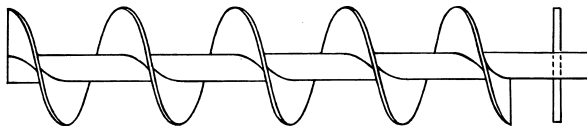

BREAKER PINS. The breaker pin is a rod approximately the same in length as the diameter of the conveyor screw and is inserted through the diameter of the pipe over the discharge to help break up lump materials.

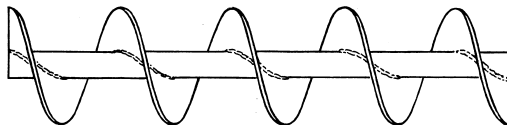

CONTINUOUS WELDING of the conveyor screw flight to the pipe can be furnished with welding one side or both sides. This welding is added to prevent stripping of flight from the pipe under extreme loads. The continuous welding can also be added to fill the slight crack between the flight and pipe for sanitary purposes.

*Martin*

## Conveyor Screws

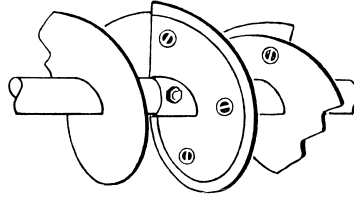

**BEARING SHOES** (Nylon, Teflon, Brass, and other bearing type materials.) Bearing shoes are used in place of internal bearings and are bolted to the conveyor screw. They are made from bearing type material, and when attached to the conveyor screw flight, the bearing shoe projects beyond the outer edge of flighting and rotates with the screw thereby preventing metal to metal contact between the conveyor screw and the trough. The bearing shoes extend around the helix slightly more than one pitch and are spaced along the screw at approximately the same intervals as internal bearings.

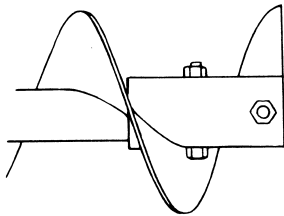

**External Sleeves**

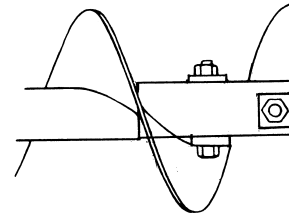

**Bolt Pads**

**EXTERNAL SLEEVES OR BOLT PADS** are added to the outside diameter of conveyor screw pipe at the end where the couplings are attached to reinforce the pipe at the bolt area.

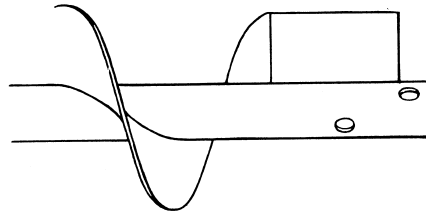

**KICKER BARS** are flat bars projecting from the conveyor screw pipe extending to the outside diameter of the screw over the discharge spout and are used to assist the discharge of materials.

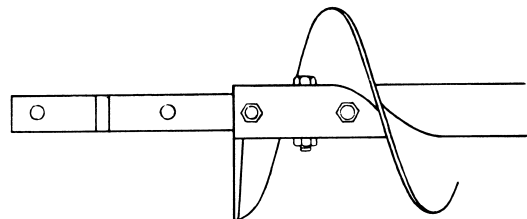

**MULTIPLE HOLE DRILLING** of the conveyor screw pipe and shafts will increase the torque rating of the bolted sections.

# Conveyor Screws

*Martin*

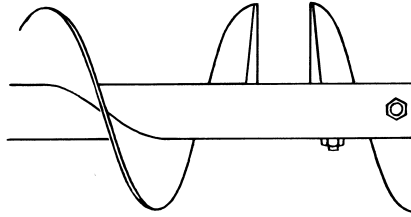

OPPOSITE HAND FLIGHTS are short sections (approximately one-half pitch) of flight added to the conveyor screw beyond the discharge point and are the opposite hand of the rest of the screw. This flight opposes the flow of material that tends to carry past the discharge spout and pack at the end plate and forces the material back to the spout for discharge.

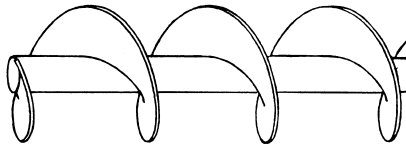

ODD DIAMETER CONVEYOR SCREW is of conventional construction except oversize or undersize in diameter. This type conveyor screw is used to provide a close clearance or wide clearance between the screw and trough and enable the use of standard component parts.

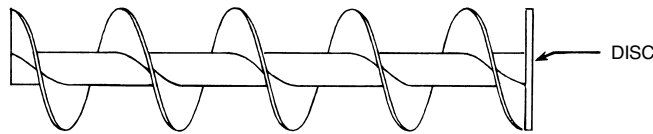

END DISC ON CONVEYOR SCREW. This disc is welded flush with the end of the conveyor screw pipe and is the same diameter as the screw. It rotates with the conveyor screw and assists in relieving the thrust of the conveyed material against the end plate shaft seal.

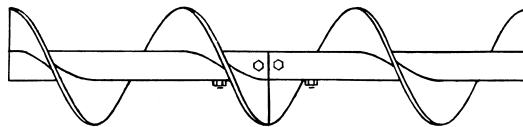

CLOSE COUPLED CONVEYOR SCREW. This type screw forms a continuous helix when two or more conveyor screws are close coupled by drilling the shaft of each to align the connecting flight.

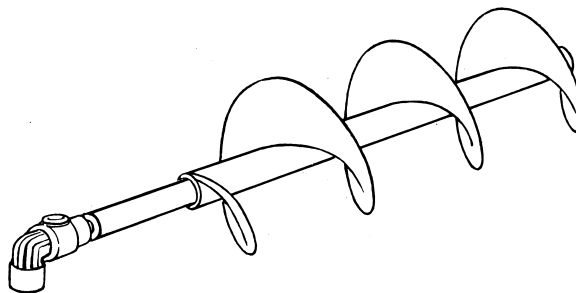

ROTARY JOINTS FOR COOLING AND HEATING are attached to one or both end shafts to provide a flow of heating or cooling media through the conveyor screw pipe.



## Discharges

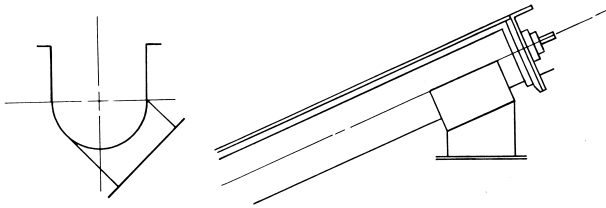

ANGULAR DISCHARGES can be furnished when necessary for certain applications. This type discharge is normally used on inclined conveyors when it is necessary that the discharge be parallel to ground level, or at other times when material must be discharged to one side.

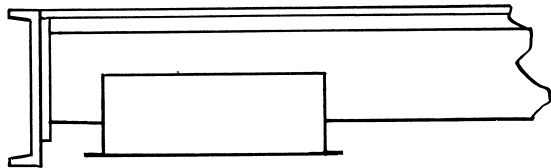

LONGER THAN STANDARD DISCHARGE SPOUTS are approximately one and one-half times the length of the standard discharge spouts. This discharge is used with materials hard to discharge due to the material trying to convey past the discharge opening. This discharge is also used when operating high speed conveyors.

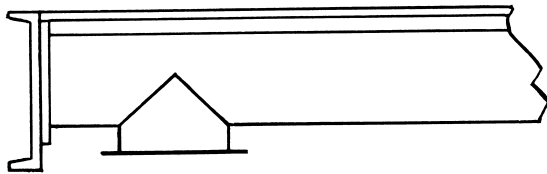

ROUND DISCHARGE SPOUTS are furnished where required for attaching tubular attachments, or when one conveyor discharges into another conveyor at an angle other than a right angle. By using a round discharge and round inlet the connection is easily made.

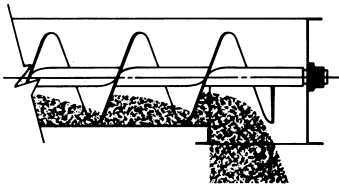

FLUSH END DISCHARGE SPOUTS are furnished with a special trough end plate constructed on trough end side of the spout. This type spout offers a complete discharge without a ledge at the end plate for material build up. It is used primarily in handling food products, where infestation may occur.

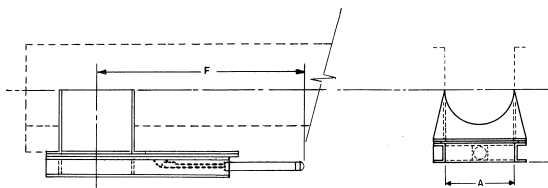

AIR OPERATED FLAT SLIDE GATES are similar in action and purpose to rack and pinion gates. The gate movement is accomplished by an air cylinder. These gates are usually employed when remote control and automatic operation is desired.

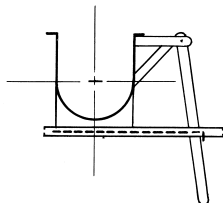

LEVER OPERATED GATES are a modification of standard slide discharges with a lever attached for opening and closing the gates. This attachment provides a leverage for ease of operation and a convenient means for quick opening and closing.

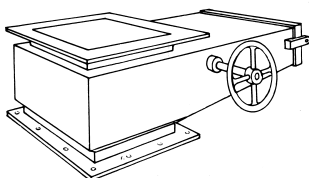

ENCLOSED DUST-TIGHT OR WEATHER-PROOF rack and pinion discharge spouts can be furnished in either flat or curved slide and are similar in construction to conventional rack and pinion slide gates except that the slide, rack, and pinion are fully enclosed in a housing.

# Discharges and Inlets

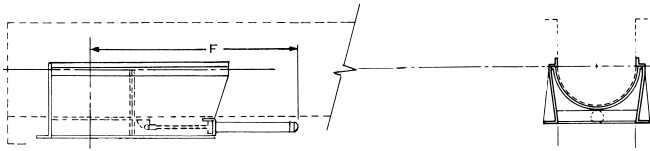

AIR OPERATED CURVED SLIDE GATES are similar to standard rack and pinion gates except they are operated with an air cylinder. The air operated gate is usually used for remote control and automatic operation. These gates can also be furnished in dust-tight or weather-proof construction with the cylinder and gate fully enclosed in the housing.

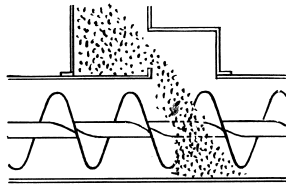

CUSHION CHAMBER INLETS (DEAD BED INLETS) serve the same purpose as the deflector plate inlet, but are constructed with a ledge that forms a cushion for materials fed into the conveyor.

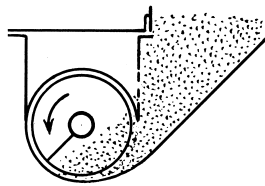

SIDE INLETS are equipped with a gate to furnish a means of regulating or stopping the inlet flow to relieve the conveyor screw from excessive material pressures. When using the side inlet, the screw rotation should be toward the inlet opening to assure a constant flow rate.

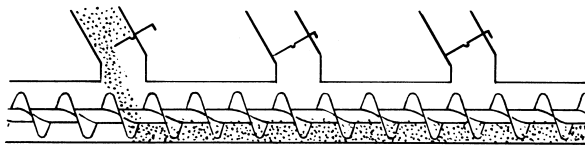

HAND SLIDE INLET GATES are normally used when multiple inlets are required. These inlets must be adjusted or closed manually to assure proper feed to the conveyor.

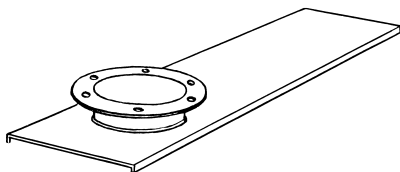

ROUND INLET SPOUTS are used for tubular attachments or when connecting the discharge of one conveyor to the inlet of another at other than a right angle. This type connection is easily made with round discharges and inlets.

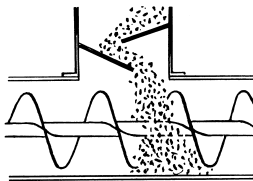

DEFLECTOR PLATE INLETS are used when materials fall vertically into the inlet creating the possibility of impact damage or abrasion to the conveyor screw. The rectangular inlet is equipped with deflector plates, or baffles, that dampen the impact of the material in order to feed the conveyor more gently.

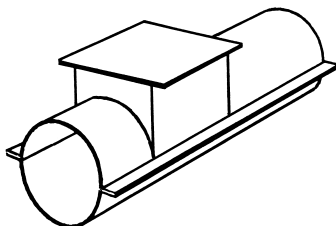

HANGER POCKETS are used with tubular trough, mounted on top of the tubular trough at hanger bearing points. The hanger pocket forms a U-shape section for a short length, allowing the use of standard conveyor hangers and providing easy access to the hanger.

CONVEYORS





# Installation & Maintenance

## INSTALLATION AND MAINTENANCE SECTION V

Installation and Erection.....	H-121
Operation and Maintenance.....	H-122
Hazardous Operations .....	H-122
Warning & Safety Reminder.....	H-123

### SECTION V General

All standard screw conveyor components are manufactured in conformity with Industry Standards. Special components are usually designed and manufactured to the particular job specifications.

Screw conveyors may be ordered either as complete units or by individual components. Complete units are normally shop assembled and then match marked and disassembled for shipment and field re-assembly. When components only are ordered, shipment is made as ordered, and these components must be sorted out and aligned in field assembly.

Because shop assembled screw conveyors are pre-aligned and match marked at the factory, they are easier to assemble in the field and require the minimum installation time. When individual components are ordered, more careful alignment and assembly are required. More time is required for field installation. Assembly bolts are not included with parts orders but are included with pre-assembled units.

**Caution:** All *Martin* Conveyors must be assembled and maintained in accordance with this section. Failure to follow these instructions may result in serious personal injury or property damage.

### Installation

#### Receiving

Check all assemblies or parts with shipping papers and inspect for damage. Specifically check for dented or bent trough, bent flanges, bent flighting, bent pipe or hangers or damaged bearings. If any components are severely damaged in shipment, claims should be filed immediately with the carrier. NOTE: Handle Carefully! Fork lifts should have spreader bars to lift max. 24' lengths of assembled conveyors. Lift points should not exceed 10 - 12 feet.

#### Erection

For shop assembled conveyors, units are match marked and shipped in longest sections practical for shipment. Field assembly can be accomplished by connecting match marked joints, and in accordance with packing list, and/or drawing if applicable. In field erection, the mounting surfaces for supporting the conveyor must be level and true so there is no distortion in the conveyor. Shims or grout should be used when required. Check for straightness as assembly is made.

For conveyor assemblies purchased as parts or merchandise, assemble as follows: Place conveyor troughs in proper sequence with inlet and discharge spout properly located. Connect the trough flanges loosely. Do not tighten bolts. Align the trough bottom center-lines perfectly using piano wire (or equivalent) then tighten flange bolts. Tighten all anchor bolts.

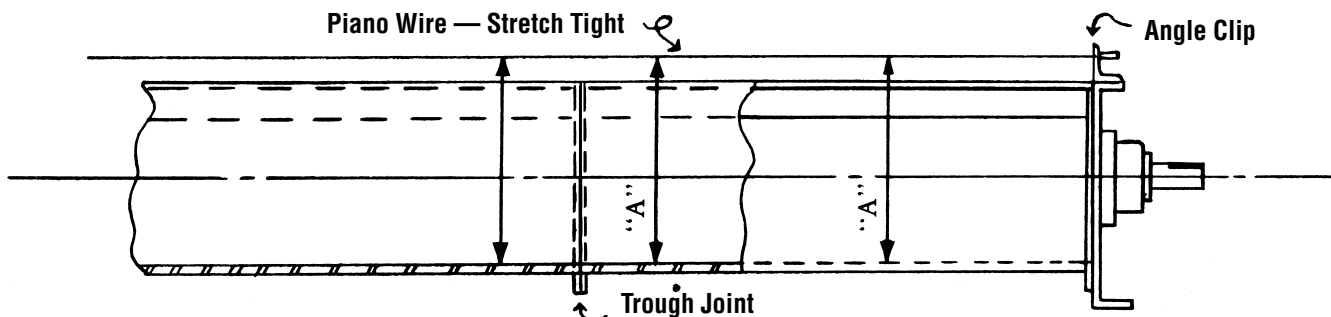

Assembly of conveyor screws should always begin at the thrust end. If the unit does not require a thrust unit, assembly should begin at the drive end. If a thrust end is designated, assemble trough end and thrust bearing. Insert the end, or drive shaft, in the end bearing. Do not tighten set screws until conveyor assembly is completed.

Place the first screw section in the trough, slipping the end, or drive shaft, into the pipe end. Secure tightly with coupling bolts. Install so that conveyor end lugs are opposite the carrying side of the flight.

Place a coupling shaft into the opposite end of conveyor pipe. Tighten coupling bolts.

Insert coupling shaft into hanger bearing and clamp hanger to trough.

Assemble alternately, conveyor screws, couplings and hangers until all screws are installed.

## Installation & Maintenance



1) **With Hangers:** Assemble screw section so that flighting at each end is approximately 180° from ends of flighting of adjacent sections. Also, adjust conveyor screw and thrust unit so that hangers are equally spaced between adjacent screws.

2) **Without Hangers:** (close coupled) Assemble screws so that flighting at adjoining ends of screw sections align to produce a continuous helix surface. (Note coupling holes have been drilled in assembly to allow for flight alignment.)

Remove hanger clamps and bolt hanger to trough with the bearing centered between conveyor screws.

Install trough covers in proper sequence. Properly locate inlet openings. Handle covers with reasonable care to avoid warping or bending.

Attach covers to trough with fasteners provided.

Install drive at proper location and in accordance with separate instructions or drawing provided.

Check screw rotation for proper direction of material travel after electrical connections have been made but before attempting to handle material. Incorrect screw rotation can result in serious damage to the conveyor and to related conveying and drive equipment.

If necessary, reconnect electrical leads to reverse rotation of conveyor and direction of material flow.

### Operation

Lubricate all bearings and drives per service instructions. Gear reducers are normally shipped without lubricant. Refer to service instructions for lubrication.

In start-up of the conveyor, operate several hours empty as a break in period. Observe for bearing heat up, unusual noises or drive misalignment. Should any of these occur, check the following and take necessary corrective steps. (Non-lubricated hanger bearings may cause some noise.)

1) When anti-friction bearings are used, check for proper lubrication. Insufficient or excess lubricant will cause high operating temperatures.

2) Misalignment of trough ends, screws, hangers and trough end can cause excessive maintenance and poor life expectancy.

3) Check assembly and mounting bolts; tighten if necessary.

Do not overload conveyor. Do not exceed conveyor speed, capacity, material density or rate of flow for which the conveyor and drive were designed.

If the conveyor is to be inoperative for a prolonged period of time, operate conveyor until cleared of all material. This is particularly important when the material conveyed tends to harden or become more viscous or sticky if allowed to stand for a period of time.

It may be necessary to recenter hanger bearings after running material in conveyor.

### Maintenance

Practice good housekeeping. Keep the area around the conveyor and drive clean and free of obstacles to provide easy access and to avoid interference with the function of the conveyor and drive.

Establish routine periodic inspections of the entire conveyor to insure continuous maximum operating performance.

To replace conveyor screw section, proceed as follows:

1) Removal of a section, or sections, usually must proceed from the end opposite the drive. Make sure drive and electrical power are disconnected before starting to disassemble.

2) Remove the trough end, sections of screws, coupling shafts and hangers until all sections have been removed or until the damaged or worn section is reached and removed.

3) To reassemble follow the above steps in reverse order.

4) Quick detachable conveyor screws can be removed at intermediate locations without first removing adjacent sections.

Replacement parts can be identified from a copy of the original packing list or invoice.

The coupling bolt contains a lock nut that may become damaged when removed. It is recommended practice to replace them rather than re-use them when changing conveyor screw sections.

### Hazardous Operations

Screw conveyors are not normally manufactured or designed to operate handling hazardous materials or in a hazardous environment.

Hazardous materials can be those that are explosive, flammable, toxic or otherwise dangerous to personnel if they are not completely and thoroughly contained in the conveyor housing. Special construction of screw and conveyor housing with gaskets and special bolted covers can sometimes be used for handling this type of material.

Special conveyors are not made or designed to comply with local, state or federal codes for unfired pressure vessels.



# Warning & Safety Reminder



## WARNING AND SAFETY REMINDERS FOR SCREW, DRAG, AND BUCKET ELEVATOR CONVEYORS

APPROVED FOR DISTRIBUTION BY THE SCREW CONVEYOR SECTION OF THE CONVEYOR EQUIPMENT MANUFACTURERS ASSOCIATION (CEMA)

It is the responsibility of the contractor, installer, owner and user to install, maintain and operate the conveyor, components and, conveyor assemblies in such a manner as to comply with the Williams-Steiger Occupational Safety and Health Act and with all state and local laws and ordinances and the American National Standards Institute (ANSI) B20.1 Safety Code.

In order to avoid an unsafe or hazardous condition, the assemblies or parts must be installed and operated in accordance with the following minimum provisions.

1. Conveyors shall not be operated unless all covers and/or guards for the conveyor and drive unit are in place. If the conveyor is to be opened for inspection, cleaning, maintenance or observation, the electric power to the motor driving the conveyor must be LOCKED OUT in such a manner that the conveyor cannot be restarted by anyone; however remote from the area, until conveyor cover or guards and drive guards have been properly replaced.
2. If the conveyor must have an open housing as a condition of its use and application, the entire conveyor is then to be guarded by a railing or fence in accordance with ANSI standard B20.1. (Request current edition and addenda)
3. Feed openings for shovel, front loaders or other manual or mechanical equipment shall be constructed in such a way that the conveyor opening is covered by a grating. If the nature of the material is such that a grating cannot be used, then the exposed section of the conveyor is to be guarded by a railing or fence and there shall be a warning sign posted.
4. Do not attempt any maintenance or repairs of the conveyor until power has been LOCKED OUT.
5. Always operate conveyor in accordance with these instructions and those contained

on the caution labels affixed to the equipment.

6. Do not place hands, feet, or any part of your body, in the conveyor.
7. Never walk on conveyor covers, grating or guards.
8. Do not use conveyor for any purpose other than that for which it was intended.
9. Do not poke or prod material into the conveyor with a bar or stick inserted through the openings.
10. Keep area around conveyor drive and control station free of debris and obstacles.
11. Eliminate all sources of stored energy (materials or devices that could cause conveyor components to move without power applied) before opening the conveyor
12. Do not attempt to clear a jammed conveyor until power has been LOCKED OUT.
13. Do not attempt field modification of conveyor or components.
14. Conveyors are not normally manufactured or designed to handle materials that are hazardous to personnel. These materials which are hazardous include those that are explosive, flammable, toxic or otherwise dangerous to personnel. Conveyors may be designed to handle these materials. Conveyors are not manufactured or designed to comply with local, state or federal codes for unfired pressure vessels. If hazardous materials are to be conveyed or if the conveyor is to be subjected to internal or external pressure, manufacturer should be consulted prior to any modifications.

CEMA insists that disconnecting and locking out the power to the motor driving the unit provides the only real protection against injury. Secondary safety devices are available; however, the decision as to their need and the type required must be made by the owner-assem-

bler as we have no information regarding plant wiring, plant environment, the interlocking of the screw conveyor with other equipment, extent of plant automation, etc. Other devices should not be used as a substitute for locking out the power prior to removing guards or covers. We caution that use of the secondary devices may cause employees to develop a false sense of security and fail to lock out power before removing covers or guards. This could result in a serious injury should the secondary device fail or malfunction.

There are many kinds of electrical devices for interlocking of conveyors and conveyor systems such that if one conveyor in a system or process is stopped other equipment feeding it, or following it can also be automatically stopped.

Electrical controls, machinery guards, railings, walkways, arrangement of installation, training of personnel, etc., are necessary ingredients for a safe working place. It is the responsibility of the contractor, installer, owner and user to supplement the materials and services furnished with these necessary items to make the conveyor installation comply with the law and accepted standards.

Conveyor inlet and discharge openings are designed to connect to other equipment or machinery so that the flow of material into and out of the conveyor is completely enclosed.

One or more warning labels should be visible on conveyor housings, conveyor covers and elevator housings. If the labels attached to the equipment become illegible, please order replacement warning labels from the OEM or CEMA.

The Conveyor Equipment Manufacturers Association (CEMA) has produced an audio-visual presentation entitled "Safe Operation of Screw Conveyors, Drag Conveyors, and Bucket Elevators." CEMA encourages acquisition and use of this source of safety information to supplement your safety program.



PROMINENTLY DISPLAY THESE SAFETY LABELS ON INSTALLED EQUIPMENT

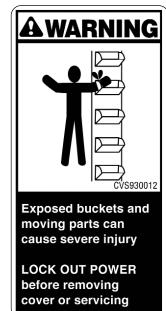
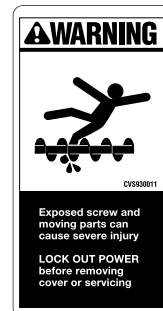

NOTICE: This document is provided by CEMA as a service to the industry in the interest of promoting safety. It is advisory only and it is not a substitute for a thorough safety program. Users should consult with qualified engineers and other safety professionals. CEMA makes no representations or warranties, either expressed or implied, and the users of this document assume full responsibility for the safe design and operation of equipment.

CONVEYORS

# Bucket Elevators



## SECTION VI

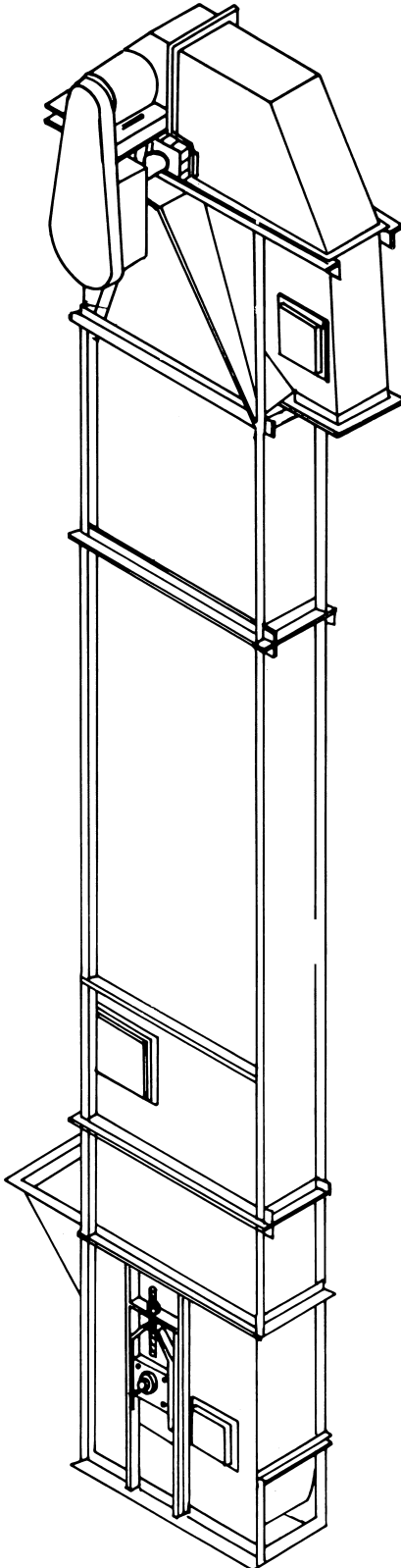

### BUCKET ELEVATORS SECTION VI

- Warning & Safety Reminder .....H-125
- Introduction.....H-126
- Standard Features Series 100 & 700 .....H-127
- Elevator Selection Procedure .....H-128
- Materials Table .....H-129
- Centrifugal Discharge Elevator
  - Series 100 and 200 Chain.....H-130
  - Series 100 and 200 Belt.....H-131
- Continuous Discharge Elevators
  - Series 700 and 800 Chain.....H-132
  - Series 700 and 800 Belt.....H-133
- Mill duty Centrifugal Discharge Elevators
  - Series MDC26 and MDC30 Chain .....H-134
  - Series MDB30 Belt.....H-135
  - Series DRB30 Belt .....H-136
- Super Capacity Continuous Discharge Elevators
  - Series SC700 Chain .....H-137
- Bucket Elevator Dimensions
  - Elevator Sketch .....H-138
  - Dimensions, 100 & 700 Belt & Chain .....H-139
- Buckets and Chain.....H-140
- Bucket Punching.....H-141
- Calculations for Numbers of Buckets.....H-142
- High Speed Grain Centrifugal Disc. Elevator
  - Series 500 Belt.....H-143

CONVEYORS



# Safety



## WARNING AND SAFETY REMINDERS FOR SCREW, DRAG, AND BUCKET ELEVATOR CONVEYORS

APPROVED FOR DISTRIBUTION BY THE SCREW CONVEYOR SECTION OF THE CONVEYOR EQUIPMENT MANUFACTURERS ASSOCIATION (CEMA)

It is the responsibility of the contractor, installer, owner and user to install, maintain and operate the conveyor, components and conveyor assemblies in such a manner as to comply with the Williams-Steiger Occupational Safety and Health Act and with all state and local laws and ordinances and the American National Standards Institute (ANSI) B20.1 Safety Code.

In order to avoid an unsafe or hazardous condition, the assemblies or parts must be installed and operated in accordance with the following minimum provisions.

1. Conveyors shall not be operated unless all covers and/or guards for the conveyor and drive unit are in place. If the conveyor is to be opened for inspection cleaning, maintenance or observation, the electric power to the motor driving the conveyor must be LOCKED OUT in such a manner that the conveyor cannot be restarted by anyone; however remote from the area, until conveyor cover or guards and drive guards have been properly replaced.
2. If the conveyor must have an open housing as a condition of its use and application, the entire conveyor is then to be guarded by a railing or fence in accordance with ANSI standard B20.1.(Request current edition and addenda)
3. Feed openings for shovel, front loaders or other manual or mechanical equipment shall be constructed in such a way that the conveyor opening is covered by a grating. If the nature of the material is such that a grating cannot be used, then the exposed section of the conveyor is to be guarded by a railing or fence and there shall be a warning sign posted.
4. Do not attempt any maintenance or repairs of the conveyor until power has been LOCKED OUT.
5. Always operate conveyor in accordance with these instructions and those contained

on the caution labels affixed to the equipment.

6. Do not place hands, feet, or any part of your body, in the conveyor.
7. Never walk on conveyor covers, grating or guards.
8. Do not use conveyor for any purpose other than that for which it was intended.
9. Do not poke or prod material into the conveyor with a bar or stick inserted through the openings.
10. Keep area around conveyor drive and control station free of debris and obstacles.
11. Eliminate all sources of stored energy (materials or devices that could cause conveyor components to move without power applied) before opening the conveyor
12. Do not attempt to clear a jammed conveyor until power has been LOCKED OUT.
13. Do not attempt field modification of conveyor or components.
14. Conveyors are not normally manufactured or designed to handle materials that are hazardous to personnel. These materials which are hazardous include those that are explosive, flammable, toxic or otherwise dangerous to personnel. Conveyors may be designed to handle these materials. Conveyors are not manufactured or designed to comply with local, state or federal codes for unfired pressure vessels. If hazardous materials are to be conveyed or if the conveyor is to be subjected to internal or external pressure, manufacturer should be consulted prior to any modifications.

CEMA insists that disconnecting and locking out the power to the motor driving the unit provides the only real protection against injury. Secondary safety devices are available; however, the decision as to their need and the type required must be made by the owner-assembler as we have no information regarding plant wiring, plant environment, the interlocking of the screw conveyor with other equipment, extent of plant automation, etc. Other devices should not be used as a substitute for locking out the power prior to removing guards or covers. We caution that use of the secondary devices may cause employees to develop a false sense of security and fail to lock out power before removing covers or guards. This could result in a serious injury should the secondary device fail or malfunction.

There are many kinds of electrical devices for interlocking of conveyors and conveyor systems such that if one conveyor in a system or process is stopped other equipment feeding it, or following it can also be automatically stopped.

Electrical controls, machinery guards, railings, walkways, arrangement of installation, training of personnel, etc., are necessary ingredients for a safe working place. It is the responsibility of the contractor, installer, owner and user to supplement the materials and services furnished with these necessary items to make the conveyor installation comply with the law and accepted standards.

Conveyor inlet and discharge openings are designed to connect to other equipment or machinery so that the flow of material into and out of the conveyor is completely enclosed.

One or more warning labels should be visible on conveyor housings, conveyor covers and elevator housings. If the labels attached to the equipment become illegible, please order replacement warning labels from the OEM or CEMA.

The Conveyor Equipment Manufacturers Association (CEMA) has produced an audio-visual presentation entitled "Safe Operation of Screw Conveyors, Drag Conveyors, and Bucket Elevators." CEMA encourages acquisition and use of this source of safety information to supplement your safety program.



PROMINENTLY DISPLAY THESE SAFETY LABELS ON INSTALLED EQUIPMENT

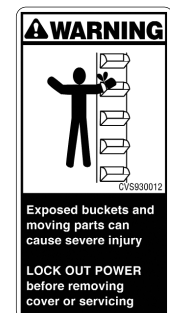
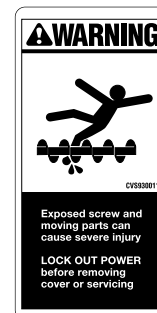

NOTICE: This document is provided by CEMA as a service to the industry in the interest of promoting safety. It is advisory only and it is not a substitute for a thorough safety program. Users should consult with qualified engineers and other safety professionals. CEMA makes no representations or warranties, either expressed or implied, and the users of this document assume full responsibility for the safe design and operation of equipment.

CONVEYORS



# Introduction



The *Martin* designs and manufactures various types of bucket elevators to efficiently handle most varieties of dry, free-flowing bulk materials. High design standards, quality manufacturing, the best possible service through many branch locations and an excellent distributor network assure many years of economical, trouble-free service.

This catalog is designed to make a preliminary selection of a bucket elevator. It shows the variety of elevators manufactured by *Martin*. Contact your local *Martin* Service Center or *Martin* distributor for a recommendation.

## Types

### Centrifugal Discharge

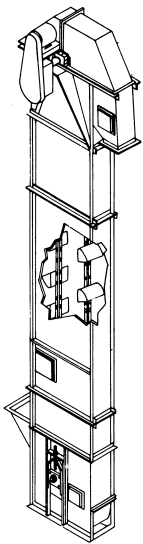

Centrifugal discharge type elevators are offered as: Series 100 (boot take up) and Series 200 (head take up). Either series is available with buckets mounted on chain or belt and will handle free-flowing materials with small to medium size lumps. The standard inlet chute and standard curved bottom plate direct the material into the buckets and reduce the “digging” action. The speed of the elevator is sufficient to discharge the material by centrifugal force.

Many types of drives and elevator materials of construction are available.

### Continuous Discharge

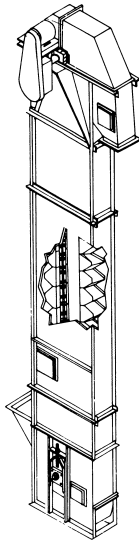

Continuous discharge elevators are offered as: Series 700 (boot take up) and Series 800 (head take up). Either series is available with buckets mounted on chain or belt and will handle free-flowing material, sluggish material or materials that are abrasive. The closely spaced fabricated buckets, with extended sides, form a “chute” to direct material into the bucket. At the discharge, the bucket configuration allows the material to discharge by gravity over the back of the preceding bucket.

Various materials of construction and thicknesses are available.

### High-Speed Centrifugal Grain

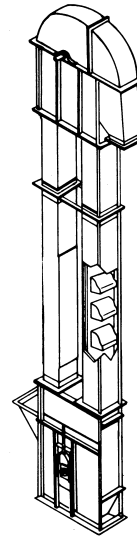

Series 500 (double leg) and Series 400 (single leg) high-speed centrifugal discharge bucket elevators are specially designed to economically handle grain and other free-flowing materials. These elevators are *not* self-supporting; therefore, intermediate supports must be provided by others.

Although the charts in this catalog are based on one type of bucket, many other styles are available. For specific recommendations contact your local *Martin* Service Center or *Martin* Conveyor Division distributor for a recommendation.

CONVEYORS

### Centrifugal Discharge - Mill Duty

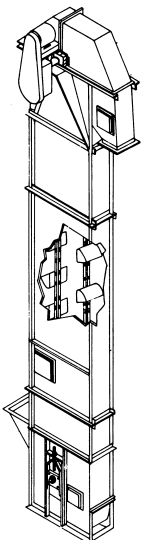

Centrifugal Mill Duty type elevators are offered with style “AC” centrifugal discharge buckets mounted on a single strand of chain, or on a belt. Chain units have a single row of buckets mounted on a single strand of chain. Belt type units may have a single or double row of buckets bolted to heavy duty rubber covered belting. Product is centrifugally discharged as material passes over the head wheel or pulley. A head mounted traction wheel is utilized in the chain type units, where practical. Lagged pulleys are standard for belt type units. Housing construction is heavy duty for severe service.

### Continuous Discharge - Super Capacity

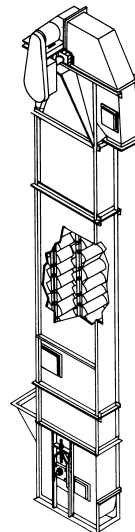

Continuous Discharge Super Capacity type elevators are offered with style “SC” continuous discharge buckets mounted between two strands of chain. These units are used where higher capacities, severe duty, or higher shaft centers are required. Housing construction is heavy duty for severe service.



# Standard Features Series 100 and Series 700

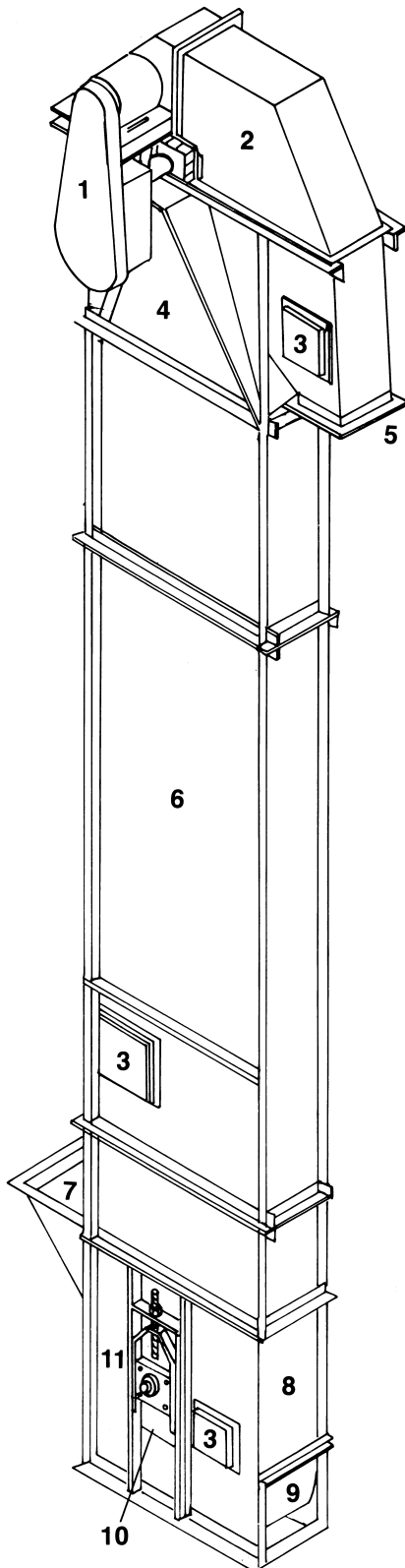

- 1. **Shaft Mount Type Drive** . . . . . Furnished as standard. Other types available. Backstops are required to prevent reverse rotation. Various types are available.
- 2. **Split Hood** . . . . . 14 gauge
- 3. **Inspection Door** . . . . . Near side
- 4. **Head Section** . . . . . Fabricated of 12 gauge steel with bearing pedestal structurally reinforced
- 5. **Discharge Spout (Style 1 shown)** . . . Fabricated of 10 gauge plate steel with externally adjustable 4-ply belting throat lip (not shown). Style 2 (45°) available. Wear liners available.
- 6. **Intermediate Section** . . . . . Fixture welded 12 gauge casing continuously welded for dust tight construction. Sides are cross crimped for additional stiffness. Vertical corner angles are full length.
- 7. **Inlet** . . . . . Fabricated of 3/16 inch thick plate steel
- 8. **Clean Out Door** . . . . . Bolted for easy removal
- 9. **Curved Bottom Plate** . . . . . Reduces build-up in boot
- 10. **Take-Up Ball Bearing Screw Type** . . For positive take-up tension. Available with roller bearings. Internal gravity type also available.
- 11. **Boot** . . . . . Fabricated of 3/16 inch thick plate steel.

## Elevator Number 100 thru 800 Series

Example — B43-139

Mounting	Bucket Size	Series	Unit No.
B	43	1	39
B = Belt C = Chain	43 = 4 × 3 64 = 6 × 4 85 = 8 × 5 106 = 10 × 6 Etc.	1 = 100 2 = 200 5 = 500 7 = 700 8 = 800	Unit 39

B43-139 is a belt (B) elevator with 4" × 3" (43) buckets, centrifugal discharge type with boot take up (Series 100), Unit 39. Specifications may be found on pages H-131.

CONVEYORS

# Elevator Selection



## General

To properly select a bucket elevator, the following factors must be determined:

- Volumetric Capacity** — in cubic feet per hour. Bucket elevators must be uniformly and continuously fed. The volumetric capacity used for selection must be the maximum the elevator will experience. Use Table 1-1 for conversions if necessary.
- Centers or Lift** — in feet
- Lump Size and Lump Class** — Lump size is the largest particle dimension, and lump class is the percentage these lumps represent of the whole.
- Material Characteristics** — See Material Classification Code Chart.
- Operating Conditions** — Conditions affecting operation include location (indoors, outdoors), number of hours per day operation, etc.

## Procedure

The following steps should be followed to select an elevator:

- Determine proper elevator series** — See material table for recommendation.
- Select Elevator Number** — For the series selected, refer to the Capacity chart, and select an elevator number for which the capacity in cubic feet per hour listed equals or exceeds the required volumetric capacity. If the required volumetric capacity of centers exceed those listed, contact the *Martin* for a recommendation.
- Check Lump Size/Lump Class** — Check actual lump size/lump class against that listed for the elevator number selected. If the actual lump size/lump class is larger than that listed, choose a larger elevator where the actual is equal to or less than that listed.
- Determine Horsepower Requirements** — Consult *Martin*.
- List Specifications** — Refer to capacity, horsepower and dimension charts for the elevator number selected. List the specifications for the preliminary selection of the elevator.

Contact your local *Martin* Service Center or *Martin*, distributor for a recommendation.

TABLE 1-1

To convert	To cubic feet per hour (CF or FT <sup>3</sup> /HR)
Tons per hour (short) TPH	CFH = $\frac{\text{TPH} \times 2000}{\text{Density (in pounds per cubic foot; PCF or LBS/FT}^3\text{)}}$
Pounds per hour Lbs/hour	CFH = $\frac{\text{Pounds per hour}}{\text{Density (in pounds per cubic foot; PCF or LBS/FT}^3\text{)}}$
Bushels per hour BPH	CFH = BPH × 1.24

Material Classification Code Chart			
Major Class	Material Characteristics Included	Code Description	
Density	Bulk Density, Loose	Actual Lbs/CF	
Size	Very Fine No. 200 Sieve (.0029") and Under No. 100 Sieve (.0059") and Under No. 40 Sieve (.016") and Under	A <sub>200</sub> A <sub>100</sub> A <sub>40</sub>	
	Fine No. 6 Sieve (.132") and Under	B <sub>6</sub>	
	Granular	½" and Under (6 Sieve to ½")	C <sub>½</sub>
		3" and Under (½ to 3") 7" and Under (3" to 7")	D <sub>½</sub> D <sub>7</sub>
	Lumpy	16" and Under (0" to 16") Over 16" To Be Specified X = Actual Maximum Size	D <sub>16</sub> D <sub>x</sub>
Flowability	Irregular Stringy, Fibrous, Cylindrical, Slabs, Etc.	1	
		2	
		3	
		4	
Abrasiveness	Mildly Abrasive	5	
	Moderately Abrasive	6	
	Extremely Abrasive	7	
Miscellaneous Properties or Hazards	Builds Up and Hardens Generates Static Electricity Decomposes — Deteriorates in Storage Flammability Becomes Plastic or Tends to Soften Very Dusty Aerates and Becomes a Fluid Explosiveness Stickiness — Adhesion Contaminable, Affecting Use Degradable, Affecting Use Gives Off Harmful or Toxic Gas or Fumes Highly Corrosive Mildly Corrosive Hygroscopic Interlocks, Mats or Agglomerates Oils Present Very Light and Fluffy — May Be Windswept Elevated Temperature	F	
		G	
		H	
		J	
		K	
		L	
		M	
		N	
		O	
		P	
		Q	
		R	
		S	
		T	
		U	
		V	
W			
Y			
Z			

CONVEYORS





# Materials Table

Material	Density LBS/FT <sup>3</sup>	Material Code	Recommended Elevator Series*
Alfalfa Meal	14-22	B6-45WY	F, H
Almonds, Broken	27-30	C½-35Q	C, F, H
Almonds, Whole Shelled	28-30	C½-35Q	F
Alum, Fine	45-50	B6-35U	A, F
Alum, Lumpy	50-60	B6-25	A, F
Alumina	55-65	B6-27MY	G
Aluminum Chips, Dry	7-15	E-45V	F
Aluminum Oxide	60-120	A100-17M	F
Ashes, Coal, Dry — 3"	35-40	D3-46T	C
Asphalt, Crushed — ½"	45	C½-45	A, C, F
Bakelite, Fine	30-45	B6-25	F
Baking Powder	40-55	A100-35	F
Bauxite, Crushed — 3"	75-85	D3-36	A, C, F
Beans, Castor, Whole Shelled	36	C½-15W	A, C, F, H
Beans, Navy, Dry	48	C½-15	A, C, F, H
Bentonite, Crude	34-40	D3-45X	A, C
Bentonite — 100 Mesh	50-60	A100-25MY	A, C
Boneblack	20-25	A100-25Y	F
Bonemeal	50-60	B6-35	A, C
Bones, Crushed	35-50	D3-45	A, C, F, H
Bones, Ground	50	B6-35	A, C, F, H
Borax, Fine	45-55	B6-25T	A, C
Bran, Rice-Rye-Wheat	16-20	B6-35NY	A, C
Brewer's Grain, spent, dry	14-30	C½-45	A, C
Brewer's Grain, spent, wet	55-60	C½-45T	A, C
Buckwheat	37-42	B6-25N	E
Calcium Oxide (See Lime, unslaked)	—	—	—
Cast Iron, Chips	130-200	C½-45	F
Cement, Clinker	75-95	D3-36	A, F
Cement, Portland	94	A100-26M	A, F
Chalk, Crushed	75-95	D3-25	A, F
Chalk, Pulverized	67-75	A100-25MY	A, F
Charcoal, Lumps	18-28	D3-45Q	F
Cinders, Coal	40	D3-36T	A, F
Clay, Brick, Dry, Fines	100-120	C½-36	B
Coal, Anthracite, Sized — ½"	49-61	C½-25	A, F
Coal, Bituminous, Mined, Slack	43-50	C½-45T	A, F
Coffee, Green Bean	25-32	C½-25PQ	A, F
Coffee, Roasted Bean	20-30	C½-25PQ	A, F
Coke, Breeze	25-35	C½-37	B, D
Coke, Loose	23-35	D7-37	D
Coke, Petrol, Calcined	35-45	D7-37	D
Copra, Cake, Ground	40-45	B6-45HW	A, C, F, G
Copra, Cake, Lumpy	25-30	D3-35HW	A, C, F
Copra, Lumpy	22	E-35HW	A, C, F
Copra, Meal	40-45	B6-35HW	A, C, F, G
Cork, Granulated	12-15	C½-35JY	F, H
Corn, Cracked	40-50	B6-25P	F, H
Corn Germ	21	B6-35PY	A, C
Corn Grits	40-45	B6-35P	A, C
Cornmeal	32-40	B6-35P	A, C
Corn Shelled	45	C½-25	E
Corn Sugar	30-35	B6-35PU	A, C
Cottonseed, Cake, Lumpy	40-45	D7-45HW	A, C
Cottonseed, Dry, Delinted	22-40	C½-25X	B, D
Cottonseed, Dry, Not Delinted	18-25	C½-45XY	B, D
Cottonseed, Hulls	12	B6-35Y	F, G
Cottonseed, Meal, Extracted	35-40	B6-45HW	A, C
Cottonseed, Meats, Dry	40	B6-35HW	A, C
Distiller's Grain, Spent Dry	30	B6-35	A, C
Dolomite, Crushed	80-100	C½-36	A, F
Ebonite, Crushed	63-70	C½-35	F
Feldspar, Ground	65-80	A100-37	A, C, F,

Material	Density LBS/FT <sup>3</sup>	Material Code	Recommended Elevator Series*
Feldspar, Powder	100	A200-36	F, H
Flaxseed	43-45	B6-35X	E
Flaxseed Cake (Linseed Cake)	48-50	D7-45W	C
Flaxseed Meal (Linseed Meal)	25-45	B6-45W	A, C
Fuller's Earth, Dry, Raw	30-40	A40-25	B, D
Fuller's Earth, Oily, Spent	60-65	C½-450W	B, D
Glass, Batch	80-100	C½-37	B, D
Granite, Fine	80-90	C½-27	F
Gypsum, Calcined	55-60	B6-35U	A, C, F, H
Gypsum, Calcined, Powdered	60-80	A100-35U	A, F
Gypsum, Raw — 1"	70-80	D3-25	F
Hops, Spent, Dry	35	D3-35	A, C
Hops, Spent, Wet	50-55	D3-45V	A, C
Ice, Crushed	35-45	D3-35Q	A, F
Ilmenite Ore	140-160	D3-37	A, C, F, G
Lime, Ground, Unslaked	60-65	B6-35U	A, C, F, G
Lime, Hydrated	40	B6-35LM	F
Lime, Pebble	53-56	C½-25HU	A, F
Limestone, Agricultural	68	B6-35	A, C, F, H
Limestone, Crushed	85-90	DX-36	F, H
Malt, Dry, Ground	20-30	B6-35NP	A, C
Malt, Meal	36-40	B6-25P	A, C
Malt, Dry Whole	20-30	C½-35N	A, C
Marble, Crushed	80-95	B6-37	F
Milk, Malted	27-30	A40-45PX	A
Oats	26	C½-25MN	E
Oats, Rolled	19-24	C½-35NY	A, C
Oxalic Acid Crystals — Ethane Diacid Crystals	60	B6-35QS	B, D
Phosphate Rock, Broken	75-85	DX-36	A, C, F, H
Phosphate Rock, Pulverized	60	B6-36	A, C, F, H
Potash (Muriate) Dry	70	B6-37	A, C, F
Pumice — ½"	42-48	B6-46	F
Rice, Bran	20	B6-35NY	E
Rice, Grits	42-45	B6-35P	A, C
Rice, Hulled	45-49	C½-25P	E
Rye	42-48	B6-15N	E
Salt Cake, Dry Coarse	85	B6-36TU	A, C, F, H
Salt, Dry Fine	70-80	B6-36TU	F, H
Sand Dry Bank (Damp)	110-130	B6-47	B, G
Sand Dry Bank (Dry)	90-110	B6-37	B, G
Sand Foundry (Shake Out)	90-100	D3-37Z	B, G
Shale, Crushed	85-90	C½-36	B, H
Slag, Blast Furnace Crushed	130-180	D3-37Y	F
Slate, Crushed — ½"	80-90	C½-36	F
Soda Ash, Heavy	55-65	B6-36	A, C
Soda Ash, Light	20-35	A40-36Y	F, H
Sodium Phosphate	50-60	A-35	A, F
Soybean, Cake	40-43	D3-35W	C
Soybean, Cracked	30-40	C½-36NW	A
Soybean, Flake, Raw	18-25	C½-35Y	A, C
Soybean, Flour	27-30	A40-35Mn	B, D
Soybean Meal, Cold	40	B6-35	A, C
Soybean Meal, Hot	40	B6-35T	A, C
Soybeans, Whole	45-50	C½-26NW	E
Sugar Beet, Pulp, Dry	12-15	C½-26	F, H
Sugar Beet, Pulp, Wet	25-45	C½-35X	F, H
Sugar, Raw	55-65	B6-35PX	A, C
Trisodium Phosphate, Granular	60	B6-36	A, F
Wheat	45-48	C½-25N	E
Wheat, Cracked	40-45	B6-25N	A, C
Wheat, Germ	18, 28	B6-25	A, C
Wood Chips, Screened	10-30	D3-45VY	B, D

\*Elevator Series Designation  
 A = Series 100 Chain  
 B = Series 100 Belt  
 C = Series 200 Chain

D = Series 200 Belt  
 E = Series 500 Belt  
 F = Series 700 Chain

G = Series 700 Belt  
 H = Series 800 Chain

CONVEYORS

# Centrifugal Discharge Chain



## Series 100 Chain (Series 200 is for Head Take-up)

Centrifugal discharge chain type elevators handle a variety of relatively free-flowing dry materials with small to medium lump sizes that are mildly to moderately abrasive.

### Buckets

Capacities and horsepower listed are for style "AA" buckets. Style "A", "AA-RB" and "Salem" can be furnished. Style "C" may also be used to handle wet or sticky materials. Consult the factory for a specific recommendation.

### Chain

Centrifugal discharge chain type elevators are furnished with either combination chain for light to medium service or all steel (steel knuckle) chain for medium to severe service or when a higher chain working load is required.

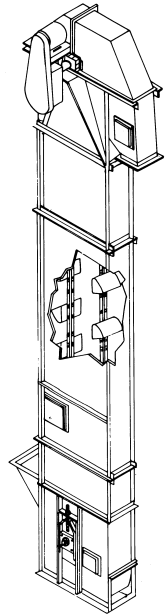

#100 Chain Centrifugal Discharge Bucket Elevator

ELEVATOR	CAPACITY	BUCKETS				CHAIN			MAX. LUMP SIZE		NOM. CASING SIZE		HEAD SPROCKET			BOOT SPROCKET		
		Number	Max. C.F.H.	Width	Proj.	Depth	Spacing	No.	Pitch	F.P.M.	100%	10%	Width	Depth	Number Teeth	Pitch Dia.	RPM	Number Teeth
C43-101	73	4	2 3/4	3	9.25	977	2.308	125	1/2	1	8	18	10	7.50	63.7	10	7.50	1.5000
C64-102	280	6	4	4 1/4	13	C188	2.609	225	1/2	2 1/2	9 3/4	35	24	20.00	43	18	15.00	1.5000
C85-103	473	8	5	5 1/2	16	N102B	4.000	200	3/4	3	11 3/4	35	14	18.00	42.4	10	13.00	1.5000
C85-104	532	8	5	5 1/2	16	N102B	4.000	225	3/4	3	11 3/4	39	16	20.50	41.9	10	13.00	1.5000
C85-105	532	8	5	5 1/2	16	HSB102B	4.000	225	3/4	3	11 3/4	39	16	20.50	41.9	10	13.00	1.5000
C85-107	591	8	5	5 1/2	16	N102B	4.000	250	3/4	3	11 3/4	42	19	24.25	39.4	14	18.00	2.0000
C85-108	591	8	5	5 1/2	16	HSB102B	4.000	250	3/4	3	11 3/4	42	19	24.25	39.4	14	18.00	2.0000
C106-110	891	10	6	6 1/4	16	N102B	4.000	220	1	3 1/2	13 3/4	42	16	20.50	41	12	15.50	2.0000
C106-111	891	10	6	6 1/4	16	HSB102B	4.000	220	1	3 1/2	13 3/4	42	16	20.50	41	12	15.50	2.0000
C106-112	900	10	6	6 1/4	18	N110	6.000	250	1	3 1/2	13 3/4	48	13	25.00	38.2	11	21.25	2.0000
C106-113	900	10	6	6 1/4	18	HSB110	6.000	250	1	3 1/2	13 3/4	48	13	25.00	38.2	11	21.25	2.0000
C106-116	1013	10	6	6 1/4	16	N102B	4.000	250	1	3 1/2	13 3/4	48	19	24.25	39.4	16	20.50	2.0000
C127-117	1425	12	7	7 1/4	18	HSB110	6.000	250	1 1/4	4	15 3/4	48	13	25.00	38.2	9	17.50	2.0000
C127-120	1568	12	7	7 1/4	18	HSB110	6.000	275	1 1/4	4	15 3/4	54	16	30.75	34.2	12	23.25	2.4375
C147-123	1569	14	7	7 1/4	19	N111	4.760	240	1 1/4	4	17 3/4	48	16	24.50	37.4	12	18.25	2.4375
C127-119	1603	12	7	7 1/4	16	N102B	4.000	250	1 1/4	4	15 3/4	48	19	24.25	39.4	14	18.00	2.0000
C147-124	1656	14	7	7 1/4	18	HSB110	6.000	240	1 1/4	4	17 3/4	48	13	25.00	36.7	9	17.50	2.4375
C127-122	1763	12	7	7 1/4	16	N102B	4.000	275	1 1/4	4	15 3/4	54	24	30.50	34.4	19	24.25	2.4375
C147-127	1798	14	7	7 1/4	19	N111	4.760	275	1 1/4	4	17 3/4	54	20	30.50	34.4	16	24.25	2.4375
C147-126	1863	14	7	7 1/4	16	N102B	4.000	240	1 1/4	4	17 3/4	48	19	24.25	37.8	14	18.00	2.4375
C147-128	1898	14	7	7 1/4	18	HSB110	6.000	275	1 1/4	4	17 3/4	54	16	30.75	34.2	12	23.25	2.4375
C147-130	2135	14	7	7 1/4	16	N102B	4.000	275	1 1/4	4	17 3/4	54	24	30.50	34.4	19	24.25	2.4375
C168-131	2319	16	8	8 1/2	19	N111	4.760	240	1 1/2	4 1/2	19 3/4	48	16	24.50	37.4	11	17.00	2.4375
C168-132	2448	16	8	8 1/2	18	HSB110	6.000	240	1 1/2	4 1/2	19 3/4	48	12	23.00	39.9	9	17.50	2.4375
C168-133	2657	16	8	8 1/2	19	N111	4.760	275	1 1/2	4 1/2	19 3/4	54	20	30.50	34.4	14	21.25	2.4375
C168-134	2805	16	8	8 1/2	18	HSB110	6.000	275	1 1/2	4 1/2	19 3/4	54	16	30.75	34.2	11	21.25	2.4375
C188-136	2808	18	8	8 1/2	18	HSB110	6.000	240	1 1/2	4 1/2	21 3/4	48	12	23.00	39.9	9	17.50	2.4375
C188-138	3218	18	8	8 1/2	18	HSB110	6.000	275	1 1/2	4 1/2	21 3/4	54	16	30.75	34.2	11	21.25	2.4375
C208-140	3024	20	8	8 1/2	18	HSB110	6.000	240	1 1/2	4 1/2	23 3/4	48	12	23.00	39.9	9	17.50	2.4375
C208-142	3465	20	8	8 1/2	18	HSB110	6.000	275	1 1/2	4 1/2	23 3/4	54	16	30.75	34.2	11	21.25	2.4375
C248-146	4703	24	8	8 1/2	18	HSB833	6.000	275	1 1/2	4 1/2	28 3/4	54	16	30.75	34.2	11	21.25	2.4375
C2410-150	6518	24	10	10 1/2	18	HSB833	6.000	275	2	4 1/2	30 3/4	60	16	30.75	34.2	11	21.25	2.4375

All Dimensions in inches.

Max. CFH capacity is at 75% bucket load.

Consult *Martin* for head shaft size and horsepower requirements.

Other chain may be substituted based on chain pull requirements.



# Centrifugal Discharge Belt

## Series 100 Belt (Series 200 is for Head Take-up)

Centrifugal discharge belt type elevators handle a variety of relatively free-flowing dry materials with small to medium lump sizes that are mildly, moderately or extremely abrasive.

### Buckets

Capacities listed are for style "AA" buckets. Style "A", "AA-RB" and "Salem" can be furnished. Style "C" may also be used to handle wet or sticky materials. Consult the factory for a specific recommendation.

### Belt

Centrifugal discharge belt type elevators are furnished with 100% polyester carcass PVC belting or rubber covered ply belts specifically designed for elevator service. Many other types of belts and covers are available.

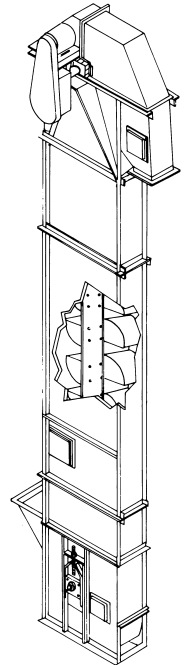

#100 Belt Centrifugal Discharge Bucket Elevator

ELEVATOR Number	CAPACITY Max. C.F.H.	BUCKETS				BELT		MAX. LUMP SIZE		NOM. CASING SIZE		HEAD PULLEY		BOOT PULLEY	
		Width	Proj.	Depth	Spacing	Width	F.P.M.	100%	10%	Width	Depth	Diameter	RPM	Diameter	Shaft Dia.
B43-139	95	4	2 3/4	3	8	5	140	1/4	1	8	18	8.00	62.9	8.00	1.5000
B64-141	293	6	4	4.25	13	7	235	1/2	2 1/2	11 3/4	35	20.00	43.8	16.00	1.5000
B64-140	324	6	4	4.25	13	7	260	1/2	2 1/2	11 3/4	39	24.00	40.5	16.00	1.5000
B85-142	543	8	5	5.5	16	9	230	3/4	3	13 3/4	39	20.00	42.9	14.00	2.0000
B85-143	591	8	5	5.5	16	9	250	3/4	3	13 3/4	42	24.00	39	16.00	2.0000
B106-144	911	10	6	6.25	16	11	225	1	3 1/2	15 3/4	42	20.00	41.9	16.00	2.0000
B106-145	1013	10	6	6.25	16	11	250	1	3 1/2	15 3/4	48	24.00	39	20.00	2.0000
B127-146	1425	12	7	7.25	18	13	250	1 1/4	4	17 3/4	48	24.00	39	20.00	2.4375
B127-147	1596	12	7	7.25	18	13	280	1 1/4	4	17 3/4	54	30.00	35.1	24.00	2.4375
B147-148	1691	14	7	7.25	18	15	245	1 1/4	4	19 3/4	48	24.00	38.2	20.00	2.4375
B147-149	1932	14	7	7.25	18	15	280	1 1/4	4	19 3/4	54	30.00	35.1	24.00	2.4375
B168-150	2550	16	8	8.5	18	17	250	1 1/2	4 1/2	22 3/4	48	24.00	39	20.00	2.4375
B168-152	2856	16	8	8.5	18	17	280	1 1/2	4 1/2	22 3/4	54	30.00	35.1	24.00	2.4375
B188-160	2925	18	8	8.5	18	19	250	1 1/2	4 1/2	24 3/4	48	24.00	39	20.00	2.4375
B208-164	3150	20	8	8.5	18	21	250	1 1/2	4 1/2	26 3/4	48	24.00	39	20.00	2.4375
B188-162	3276	18	8	8.5	18	19	280	1 1/2	4 1/2	24 3/4	54	30.00	35.1	24.00	2.4375
B208-166	3528	20	8	8.5	18	21	280	1 1/2	4 1/2	26 3/4	54	30.00	35.1	24.00	2.4375
B127-146S	4489	12	7	7.25	16	24	350	1 1/4	4	28	66	42.00	31.5	30.00	2.4375
B248-168	4788	24	8	8.5	18	25	280	1 1/2	4 1/2	30 3/4	54	30.00	35.1	24.00	2.4375
B2410-170	6636	24	10	10.5	18	25	280	1 1/2	4 1/2	30 3/4	60	30.00	35.1	24.00	2.4375

All Dimensions in inches.

Max. CFH capacity is at 75% bucket load.

Consult *Martin* for head shaft size and horsepower requirements.

CONVEYORS

# Continuous Discharge Chain



## Series 700 Chain (Series 800 is for Head Take-up)

Continuous discharge chain type elevators will handle various free-flowing dry or sluggish materials which contain medium to large lumps and are mildly, moderately, or extremely abrasive.

### Buckets

Capacities listed are for a medium-front, non-overlapping style fabricated steel bucket. High front style buckets are available. Consult the factory for a specific recommendation.

### Chain

Continuous discharge chain type elevators are furnished with combination chain for mild to moderate service or all steel (steel knuckle) chain for moderate to severe service or when a higher chain working load is required.

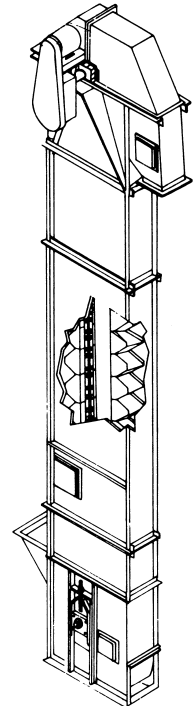

#700 Chain Continuous Discharge Bucket Elevator

ELEVATOR Number	CAPACITY	BUCKETS				CHAIN			MAX. LUMP SIZE		NOM. CASING SIZE		HEAD SPROCKET			BOOT SPROCKET		
	Max. C.F.H.	Width	Proj.	Depth	Spacing	No.	Pitch	F.P.M.	100%	10%	Width	Depth	Number Teeth	Pitch Dia.	RPM	Number Teeth	Pitch Diameter	Shaft Diameter
C85-766	567	8	5	7 3/4	8	N102B	4.000	120	3/4	2 1/2	11 3/4	39	16	20.50	22.4	11	14.25	1.5000
C85-767	567	8	5	7 3/4	8	HSB102B	4.000	120	3/4	2 1/2	11 3/4	39	16	20.50	22.4	11	14.25	1.5000
C105-768	729	10	5	7 3/4	8	N102B	4.000	120	3/4	2 1/2	11 3/4	39	16	20.50	22.4	11	14.25	2.0000
C105-769	729	10	5	7 3/4	8	HSB102B	4.000	120	3/4	2 1/2	13 3/4	39	16	20.50	22.4	11	14.25	2.0000
C107-770	1013	10	7	11 5/8	12	N110	6.000	125	1	3	13 3/4	48	13	25.00	19.1	10	19.50	2.0000
C107-771	1013	10	7	11 5/8	12	HSB110	6.000	125	1	3	13 3/4	48	13	25.00	19.1	10	19.50	2.0000
C127-772	1226	12	7	11 5/8	12	N110	6.000	125	1	3	15 3/4	48	13	25.00	19.1	10	19.50	2.4375
C127-773	1226	12	7	11 5/8	12	HSB110	6.000	125	1	3	15 3/4	48	13	25.00	19.1	10	19.50	2.4375
C147-774	1423	14	7	11 5/8	12	N110	6.000	125	1	3	17 3/4	48	13	25.00	19.1	10	19.50	2.4375
C147-775	1423	14	7	11 5/8	12	HSB110	6.000	125	1	3	17 3/4	48	13	25.00	19.1	10	19.50	2.4375
C128-776	1547	12	8	11 5/8	12	N110	6.000	125	1 1/4	4	15 3/4	48	13	25.00	19.1	9	17.50	2.4375
C128-777	1547	12	8	11 5/8	12	HSB110	6.000	125	1 1/4	4	15 3/4	48	13	25.00	19.1	9	17.50	2.4375
C148-778	1828	14	8	11 5/8	12	N110	6.000	125	1 1/4	4	17 3/4	48	13	25.00	19.1	9	17.50	2.4375
C148-779	1828	14	8	11 5/8	12	HSB110	6.000	125	1 1/4	4	17 3/4	48	13	25.00	19.1	9	17.50	2.4375
C168-781	2109	16	8	11 5/8	12	HSB110	6.000	125	1 1/2	4 1/2	19 3/4	48	13	25.00	19.1	9	17.50	2.4375
C188-783	2363	18	8	11 5/8	12	HSB110	6.000	125	1 1/2	4 1/2	22 3/4	48	13	25.00	19.1	9	17.50	2.4375
C208-785	2784	20	8	11 5/8	12	HSB833	6.000	125	1 1/2	4 1/2	24 3/4	48	13	25.00	19.1	9	17.50	2.4375
C248-787	3375	24	8	11 5/8	12	HSB833	6.000	125	1 1/2	4 1/2	28 3/4	48	13	25.00	19.1	9	17.50	2.4375
C2010-786	3881	20	10	11 5/8	12	HSB833	6.000	125	2	4 1/2	24 3/4	54	13	25.00	19.1	9	17.50	2.4375
C2410-788	4669	24	10	11 5/8	12	HSB833	6.000	125	2	4 1/2	28 3/4	54	13	25.00	19.1	9	17.50	2.4375

All Dimensions in inches.

Max. CFH capacity is at 75% bucket load.

Consult *Martin* for head shaft size and horsepower requirements.

Other chain may be substituted based on chain pull requirements.

CONVEYORS



# Continuous Discharge Belt

## Series 700 Belt (Series 800 is for Head Take-up)

Continuous discharge belt type elevators will handle various free-flowing dry or sluggish materials which contain medium to large lumps and are mildly, moderately, or extremely abrasive.

### Buckets

Capacities listed are for a medium front, non-overlapping style fabricated steel bucket. High front style buckets are available. Consult the factory for a specific recommendation.

### Belt

Continuous discharge belt type elevators are furnished with 100% polyester carcass PVC belting or rubber covered ply belts specifically designed for elevator service. Many other types of belt and covers are available.

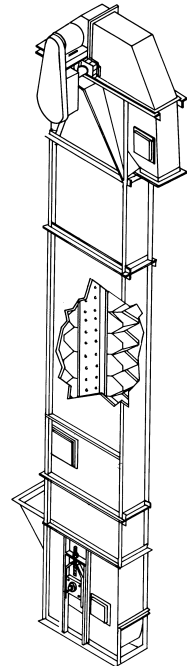

#700 Belt Continuous Discharge Bucket Elevator

ELEVATOR Number	CAPACITY Max.C.F.H.	BUCKETS			BELT			MAX. LUMP SIZE		NOM. CASING SIZE		HEAD PULLEY		BOOT PULLEY	
		Width	Proj.	Depth	Spacing	Width	F.P.M.	100%	10%	Width	Depth	Diameter	RPM	Diameter	Shaft Dia.
B85-790	756	8	5	7 3/4	8	9	160	3/4	2 1/2	11 3/4	39	20.00	29.8	14.00	1.5000
B105-791	972	10	5	7 3/4	8	11	160	3/4	2 1/2	13 3/4	39	20.00	29.8	14.00	1.5000
B107-792	1296	10	7	11 5/8	12	11	160	1	3	13 3/4	48	24.00	24.9	20.00	2.0000
B127-793	1570	12	7	11 5/8	12	13	160	1	3	15 3/4	48	24.00	24.9	20.00	2.0000
B147-794	1822	14	7	11 5/8	12	15	160	1	3	17 3/4	48	24.00	24.9	20.00	2.0000
B128-795	1980	12	8	11 5/8	12	13	160	1 1/4	4	15 3/4	48	24.00	24.9	20.00	2.0000
B148-796	2340	14	8	11 5/8	12	15	160	1 1/4	4	17 3/4	48	24.00	24.9	20.00	2.4375
B168-797	2700	16	8	11 5/8	12	17	160	1 1/2	4 1/2	19 3/4	48	24.00	24.9	20.00	2.4375
B188-798	3024	18	8	11 5/8	12	19	160	1 1/2	4 1/2	22 3/4	48	24.00	24.9	20.00	2.4375
B208-720	3564	20	8	11 5/8	12	21	160	1 1/2	4 1/2	24 3/4	48	24.00	24.9	20.00	2.4375
B248-722	4320	24	8	11 5/8	12	25	160	1 1/2	4 1/2	28 3/4	48	24.00	24.9	20.00	2.4375
B2010-724	4968	20	10	11 5/8	12	21	160	1 1/2	4 1/2	24 3/4	54	24.00	24.9	20.00	2.4375
B2410-726	5976	24	10	11 5/8	12	25	160	1 1/2	4 1/2	28 3/4	54	24.00	24.9	20.00	2.4375

All Dimensions in inches.  
 Max. CFH capacity is at 75% bucket load.  
 Consult *Martin* for head shaft size and horsepower requirements.

CONVEYORS

# Mill Duty Centrifugal Discharge Chain



## Series MDC26 & MDC30 Chain

Mill duty centrifugal discharge chain type bucket elevators handle a variety of relatively free flowing dry materials with small to medium lump sizes that are mildly to moderately abrasive. Extensively used in the cement industry.

### Buckets

Capacities listed are for style "AC" buckets. Buckets may be vented for handling light, fluffy materials.

### Chain

Mill duty centrifugal discharge chain type bucket elevators are furnished with heavy duty steel knuckle chain for medium to severe service, selected for required work loads.

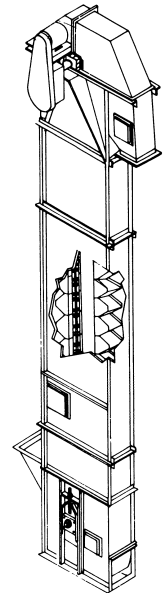

Mill Duty Chain Centrifugal Discharge Bucket Elevator

ELEVATOR Number	CAPACITY Max. C.F.H.	BUCKETS				CHAIN			MAX. LUMP SIZE		NOM. CASING SIZE		HEAD SPROCKET			BOOT SPROCKET		
		Width	Proj.	Depth	Spacing	No.	Pitch	F.P.M.	100%	10%	Width	Depth	Number Teeth	Pitch Dia.	RPM	Number Teeth	Pitch Diameter	Shaft Diameter
MDC26 -128A	2226	12	8	8 1/2	18	HSB833	6.000	265	1 1/2	4	20	56	26	27.00	37.5	13	25.03	3.000
MDC26 -148A	2624	14	8	8 1/2	18	HSB833	6.000	265	1 1/2	4	22	56	26	27.00	37.5	13	25.03	3.000
MDC26 -168A	3021	16	8	8 1/2	18	HSB833	6.000	265	1 3/4	4 1/2	24	56	26	27.00	37.5	13	25.03	3.000
MDC26 -128B	3339	12	8	8 1/2	12	HSB833	6.000	265	1 1/2	4	20	56	26	27.00	37.5	13	25.03	3.000
MDC26 -148B	3935	14	8	8 1/2	12	HSB833	6.000	265	1 1/2	4	22	56	26	27.00	37.5	13	25.03	3.000
MDC26 -168B	4532	16	8	8 1/2	12	HSB833	6.000	265	1 3/4	4 1/2	24	56	26	27.00	37.5	13	25.03	3.000
MDC26-1810A	4929	18	10	10 1/2	18	HSB856	6.000	265	2	5	26	64	26	27.25	37.1	13	25.05	3.000
MDC30 - 168B	5387	16	8	8 1/2	12	HSB833	6.000	315	1 3/4	4 1/2	24	60	30	31.00	38.8	15	28.81	3.000
MDC26-2010A	5470	20	10	10 1/2	18	HSB856	6.000	265	2	5	28	64	26	27.25	37.1	13	25.05	3.000
MDC30-1810A	5859	18	10	10 1/2	18	HSB856	6.000	315	2	5	26	68	30	31.25	38.5	15	28.82	3.000
MDC30-2010A	6502	20	10	10 1/2	18	HSB856	6.000	315	2	5	28	68	30	31.25	38.5	15	28.82	3.000
MDC26-2410A	6758	24	10	10 1/2	18	HSB856	6.000	265	2	5	32	64	26	27.25	37.1	13	25.05	3.000
MDC26-1810B	7394	18	10	10 1/2	12	HSB859	6.000	265	2	5	26	64	26	28.00	36.2	13	25.05	3.000
MDC30-2410A	8033	24	10	10 1/2	18	HSB856	6.000	315	2	5	32	68	30	31.25	38.5	15	28.82	3.000
MDC26-2010B	8204	20	10	10 1/2	12	HSB859	6.000	265	2	5	28	64	26	28.00	36.2	13	25.05	3.000
MDC30-1810B	8789	18	10	10 1/2	12	HSB859	6.000	315	2	5	26	68	30	32.00	37.6	15	28.82	3.000
MDC30-2010B	9752	20	10	10 1/2	12	HSB859	6.000	315	2	5	28	68	30	32.00	37.6	15	28.82	3.000
MDC26-2410B	10136	24	10	10 1/2	12	HSB859	6.000	265	2	5	32	64	26	28.00	36.2	13	25.05	3.000
MDC30-2410B	12049	24	10	10 1/2	12	HSB859	6.000	315	2	5	32	68	30	32.00	37.6	15	28.82	3.000

All Dimensions in inches.

Max. CFH capacity is at 75% bucket load.

Consult *Martin* for head shaft size and horsepower requirements.

Other chain may be substituted based on chain pull requirements.

Internal gravity take-ups are standard.

CONVEYORS





# Mill Duty Centrifugal Discharge Belt

## Series MDB30 Belt

Mill duty centrifugal discharge belt type bucket elevators handle high capacities of various relatively free flowing dry materials with small to medium lump sizes that are mildly to moderately abrasive.

### Buckets

Capacities listed are for style "AC" buckets. Buckets may be vented for handling light, fluffy materials.

### Belt

Mill duty centrifugal discharge belt type bucket elevators are furnished with heavy duty rubber covered ply belts or 100% polyester carcass PVC belts specifically selected for elevator service.

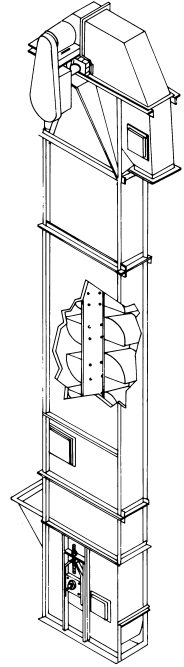

## Mill Duty Belt Centrifugal Discharge Bucket Elevator

ELEVATOR Number	CAPACITY Max. C.F.H.	BUCKETS			BELT			MAX. LUMP SIZE		NOM. CASING SIZE		HEAD PULLEY		BOOT PULLEY	
		Width	Proj.	Depth	Spacing	Width	F.P.M.	100%	10%	Width	Depth	Diameter	RPM	Diameter	Shaft Dia.
MDB30-128A	2520	12	8	8 1/2	18	14	300	1 1/2	4	22	58	30.00	37.6	24.00	3.0000
MDB30-148A	2970	14	8	8 1/2	18	16	300	1 1/2	4	24	58	30.00	37.6	24.00	3.0000
MDB30-168A	3420	16	8	8 1/2	18	18	300	1 3/4	4 1/2	26	58	30.00	37.6	24.00	3.0000
MDB30-128B	3780	12	8	8 1/2	12	14	300	1 1/2	4	22	58	30.00	37.6	24.00	3.0000
MDB30-148B	4455	14	8	8 1/2	12	16	300	1 1/2	4	24	58	30.00	37.6	24.00	3.0000
MDB30-168B	5130	16	8	8 1/2	12	18	300	1 3/4	4 1/2	26	58	30.00	37.6	24.00	3.0000
MDB30-1810A	5580	18	10	10 1/2	18	20	300	2	5	28	64	30.00	37.6	24.00	3.0000
MDB30-2010A	6192	20	10	10 1/2	18	22	300	2	5	30	64	30.00	37.6	24.00	3.0000
MDB30-2410A	7650	24	10	10 1/2	18	26	300	2	5	34	64	30.00	37.6	24.00	3.0000
MDB30-1810B	8370	18	10	10 1/2	12	20	300	2	5	28	64	30.00	37.6	24.00	3.0000
MDB30-2010B	9288	20	10	10 1/2	12	22	300	2	5	30	64	30.00	37.6	24.00	3.0000
MDB30-2410B	11475	24	10	10 1/2	12	26	300	2	5	34	64	30.00	37.6	24.00	3.0000

All Dimensions in inches.

Max. CFH capacity is at 75% bucket load.

Consult *Martin* for head shaft size and horsepower requirements.

Screw take-ups are standard.

CONVEYORS

# Double Row Mill Duty Centrifugal Discharge Belt



## Series DRB30 Belt

Double row mill duty centrifugal discharge belt type bucket elevators handle high capacities of various relatively free flowing dry materials with small to medium lump sizes that are mildly to moderately abrasive.

### Buckets

Capacities listed are for a double row of style "AC" buckets. Buckets may be vented for handling light, fluffy materials.

### Belt

Double row mill duty centrifugal discharge belt type bucket elevators are furnished with heavy duty rubber covered ply belts or 100% polyester carcass PVC belts specifically selected for elevator service.

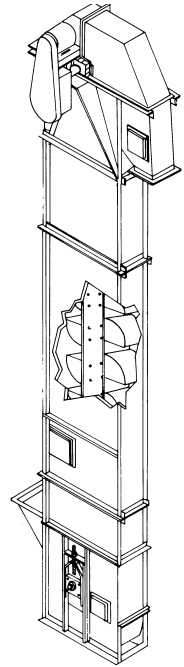

**Double Row Mill Duty Belt Centrifugal Discharge Bucket Elevator**

ELEVATOR Number	CAPACITY Max. C.F.H.	BUCKETS			BELT			MAX. LUMP SIZE		NOM. CASING SIZE		HEAD PULLEY		BOOT PULLEY	
		Width	Proj.	Depth	Spacing	Width	F.P.M.	100%	10%	Width	Depth	Diameter	RPM	Diameter	Shaft Dia.
DRB30-128A	8316	12	8	8 1/2	10	26	275	1 1/2	4	34	58	30.00	34.4	30.00	3.000
DRB30-1210A	9207	12	10	10 1/2	12	26	275	1 1/2	4	34	62	30.00	34.4	30.00	3.000
DRB30-148A	9801	14	8	8 1/2	10	30	275	1 1/2	4	38	58	30.00	34.4	30.00	3.000
DRB30-1410A	10841	14	10	10 1/2	12	30	275	1 1/2	4	38	62	30.00	34.4	30.00	3.000
DRB30-168A	11286	16	8	8 1/2	10	34	275	1 3/4	4 1/2	42	58	30.00	34.4	30.00	3.000
DRB30-1610A	12499	16	10	10 1/2	12	34	275	1 3/4	4 1/2	42	62	30.00	34.4	30.00	3.000
DRB30-1810A	15345	18	10	10 1/2	12	38	275	2	4 1/2	46	62	30.00	34.4	30.00	3.000
DRB30-2010A	17028	20	10	10 1/2	12	42	275	2 1/4	4 3/4	50	62	30.00	34.4	30.00	3.000
DRB30-2410A	21038	24	10	10 1/2	12	50	275	2 1/2	5	58	62	30.00	34.4	30.00	3.000

All Dimensions in inches.

Max. CFH capacity is at 75% bucket load.

Consult *Martin* for head shaft size and horsepower requirements.

Screw take-ups are standard.





# Super Capacity Continuous Discharge Chain

## Series SC700 Chain

Super Capacity continuous discharge chain type bucket elevators handle high capacities of various free flowing dry materials ranging from fines to lumps, moderate to extremely abrasive, and those that tend to pack.

### Buckets

Capacities listed are for style "SC" continuous fabricated steel buckets, mounted between tow strand of chain.

### Chain

Super Capacity continuous discharge chain type bucket elevators are furnished with two strands of heavy duty steel knuckle chain for moderate to severe service, selected for required work loads.

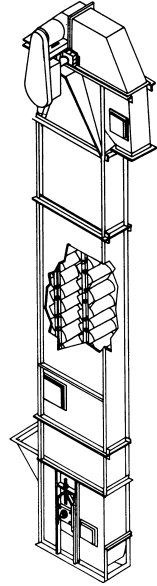

Super Capacity Continuous Discharge Bucket Elevator

ELEVATOR Number	CAPACITY Max. C.F.H.	BUCKETS				CHAIN			MAX. LUMP SIZE		NOM. CASING SIZE		HEAD SPROCKET			BOOT SPROCKET		
		Width	Proj.	Depth	Spacing	No.	Pitch	F.P.M.	100%	10%	Width	Depth	Number Teeth	Pitch Dia.	RPM	Number Teeth	Pitch Diameter	Shaft Diameter
SC700-128	2250	12	8.75	11.625	12	6102 1/2	12	100	2	4	26	56	8	31.36	12.2	6	23.96	2.4375
SC700-148	2700	14	8.75	11.625	12	6102 1/2	12	100	2	4	28	56	8	31.36	12.2	6	23.96	2.4375
SC700-168	3150	16	8.75	11.625	12	6102 1/2	12	100	2 1/2	6	30	56	8	31.36	12.2	6	23.96	3.0000
SC700-188	3600	18	8.75	11.625	12	6102 1/2	12	100	2 1/2	6	32	56	8	31.36	12.2	6	23.96	3.0000
SC700-208	4050	20	8.75	11.625	12	6102 1/2	12	100	2 1/2	6	34	56	8	31.36	12.2	6	23.96	3.0000
SC700-1612	5625	16	12.75	17.625	18	9124	9	125	3 1/2	8	33	68	12	34.77	13.7	12	34.77	3.0000
SC700-2012	7125	20	12.75	17.625	18	9124	9	125	3 1/2	8	37	68	12	34.77	13.7	12	34.77	3.0000
SC700-2412	8250	24	12.75	17.625	18	9124	9	125	3 1/2	8	41	68	12	34.77	13.7	12	34.77	3.0000
SC700-3012	10500	30	12.75	17.625	18	9124	9	125	3 1/2	8	47	68	12	34.77	13.7	12	34.77	3.0000
SC700-3612	12375	36	12.75	17.625	18	9124	9	125	3 1/2	8	53	68	12	34.77	13.7	12	34.77	3.4375
SC700-4212	14437.5	42	12.75	17.625	18	9150	9	125	3 1/2	8	60	68	12	34.77	13.7	12	34.77	3.4375
SC700-4812	16500	48	12.75	17.625	18	9150	9	125	3 1/2	8	66	68	12	34.77	13.7	12	34.77	3.4375

All Dimensions in inches.

Max. CFH capacity is at 75% bucket load.

Consult *Martin* for head shaft size and horsepower requirements.

Internal gravity take-ups are standard.

CONVEYORS

# Bucket Elevator Dimensions

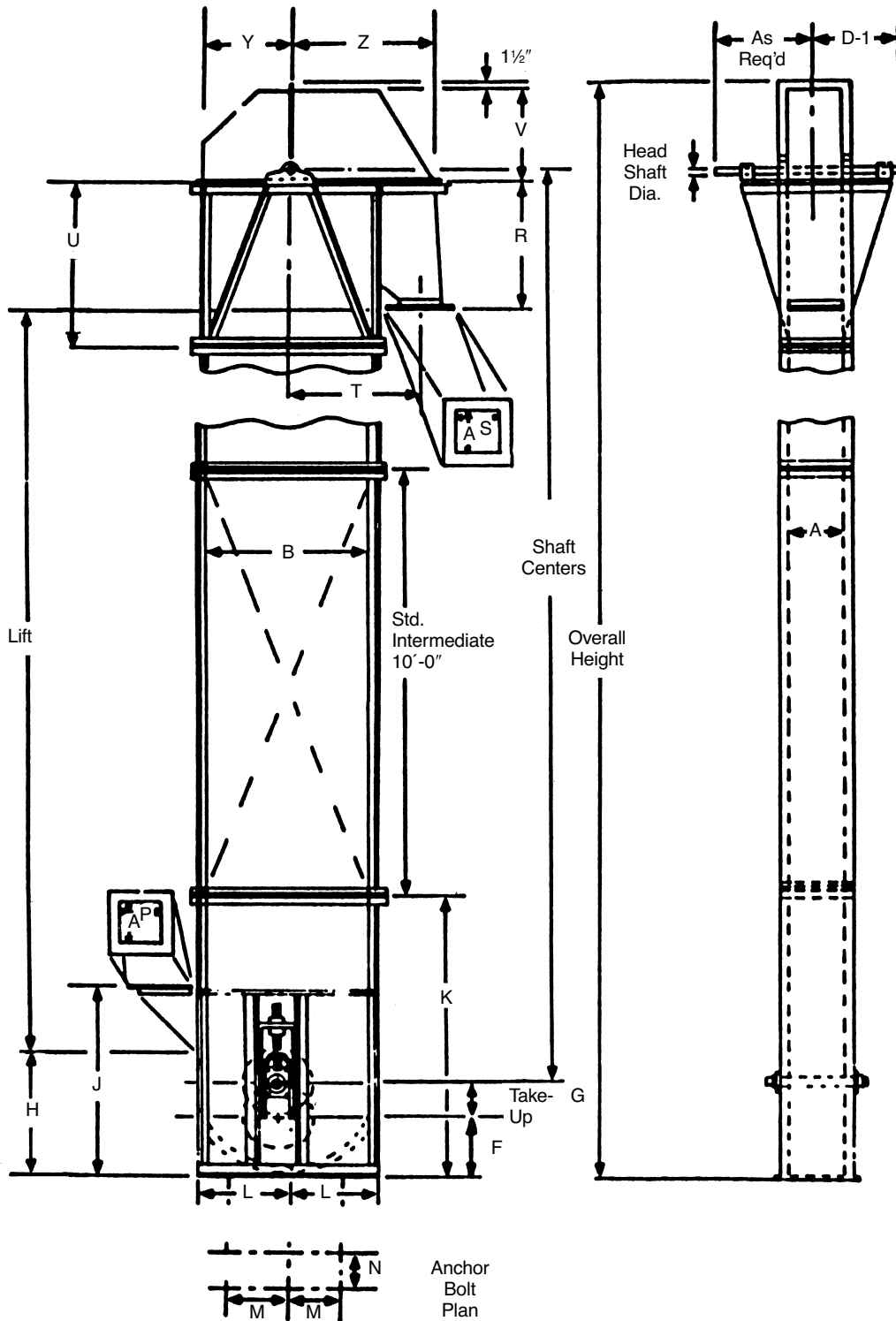

CONVEYORS



# Bucket Elevator Dimensions

## 100 & 700 Belt & Chain

				Dimensions <sup>®</sup> (In Inches)																		
Elevator Number Chain	Elevator Number Belt	Elevator Number Belt	Elevator Number Chain	Casing		Boot								Head								
				A	B	F	G	H	J	K	L	M	N	P	R	S	T	U	V	Y	Z	D-1 <sup>2</sup>
C43-101		B43-139		8	18	9	6	27¼	36¾	42	9	6	10	6	15	8	17½	36	14	9	20¼	13
C64-102				9¾	35	13	9	26½	43	72	17½	14½	13½	13	29¾	10	28½	42	19½	17½	30½	13
		B64-140		11¾	39	14	9	26½	43	72	19½	16½	15½	13	31½	10	30½	42	21½	19½	32½	14
C85-103		B64-141		11¾	35	13	9	26½	43	72	17½	14½	15½	13	29¾	10	28½	42	19½	17½	30½	14
C85-104	B85-790		C85-766	11¾	39	14	9	26½	43	72	19½	16½	15½	13	31½	10	30½	42	21½	19½	32½	14
C85-105			C85-767																			
C85-107					11¾	42	16	9	32½	50	72	21	18	15½	13	32¾	10	33¾	42	24	21	36¾
C85-108																						
	B105-791	B85-142	C105-768	13¾	39	14	9	26½	43	72	19½	16½	17½	13	31½	10	30½	42	21½	19½	32½	15
C106-110																						
C106-111		B85-143		13¾	42	16	9	32½	50	72	21	18	17½	13	32¾	10	33¾	42	24	21	36¾	15½
C106-112																						
C106-113	B107-792		C107-770	13¾	48	19	9	40½	60	72	24	21	17½	15	35¾	13	36½	48	27½	24	40%	16
C106-116			C107-771																			
		B106-144		15¾	42	16	9	32½	50	72	21	18	19½	13	32¾	10	33¾	42	24	21	36¾	17
C127-117	B127-793		C127-772																			
C127-119		B128-795	B106-145	C127-773	15¾	48	19	9	40½	60	72	24	21	19½	15	35¾	13	36½	48	27½	24	40%
C127-120			C128-776																			
C127-122			C128-777	15¾	54	21	10	39	60½	72	27	24	19½	17	38¾	17	41½	48	31	27	45	18¼
		B127-146																				
		S		28	64	26	10	29¾	60½	72	32	29	30½	26¼	36	17	46½	48	36½	32	53	24
C147-123	B147-794		C147-774																			
C147-124		B147-796	B127-146	C147-775	17¾	48	19	10	40½	60	72	24	21	21½	15	35¾	13	36½	48	27½	24	40%
C147-126			C148-778																			
C147-127			C148-779																			
C147-128																						
C147-130		B127-147		17¾	54	21	10	39	60½	72	27	24	21½	17	38¾	17	41½	48	31	27	45	19¼
C168-131			C168-780																			
C168-132	B168-797	B147-148	C168-781	19¾	48	19	10	40½	60	72	24	21	23½	15	35¾	13	36½	48	27½	24	40%	19
C168-133																						
C168-134		B147-149		19¾	54	21	10	39	60½	72	27	24	23½	17	38¾	17	41½	48	31	27	45	20
	B188-798	B168-150	C188-782	22¾	48	19	10	40½	60	72	24	21	26½	15	35¾	13	36½	48	27½	24	40%	21
			C188-783																			
		B168-152		22¾	54	21	10	39	60½	72	27	24	26½	17	38¾	17	41½	48	31	27	45	22

<sup>1</sup>NOT certified for construction.  
<sup>2</sup>Normal maximum for largest headshaft listed.  
 For units not shown, contact *Martin*.

CONVEYORS

# Buckets and Chain



## Style AA

Ductile iron buckets for general use with most types of relatively free flowing material in centrifugal discharge elevators. Can be mounted on chain or belt and furnished in various plastic materials.

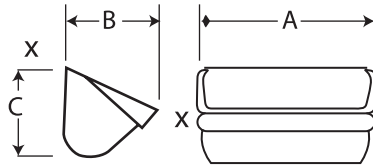

Bucket Size			Weight Lbs.	Capacity cu. ft. X-X
A	B	C		
4	2 1/4	3	1.0	.01
6	4	4 1/4	2.7	.03
8	5	5 1/2	4.8	.07
10	6	6 1/4	7.7	.12
12	7	7 1/4	12.0	.19
14	7	7 1/4	13.9	.23
16	8	8 1/2	21.8	.34

## Style C

Fabricated buckets are used in centrifugal discharge elevators to handle materials that tend to pack or stick, such as sugar, clay, salt or wet grains.

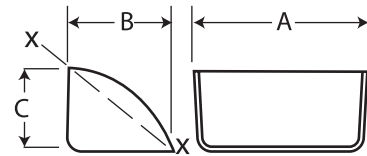

Bucket Size			Weight Lbs.	Capacity cu. ft. X-X
A	B	C		
6	4 1/2	4	2.0	.026
8	4 1/2	4	2.8	.035
10	5	4	4.0	.052
12	5	4	4.8	.061
14	7	5 1/2	8.5	.138
16	7	5 1/2	10.5	.158

## Continuous

Medium front non-overlapping fabricated steel buckets are used in continuous discharge elevators for general service. Heavier gauges should be used when handling abrasive materials. Available fabricated from various materials. High front continuous buckets are available also. Plastic buckets available in most sizes.

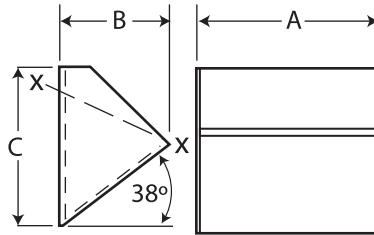

Bucket Size			Weight Lbs.				Capacity cu. ft. X-X
A	B	C	12 Ga.	10 Ga.	3/16"	1/4"	
8	5	7 1/4	5.1	6.3	8.7	—	.070
10	5	7 1/4	5.9	7.4	10.2	—	.090
10	7	11 1/2	9.3	11.9	16.5	—	.180
12	7	11 1/2	10.4	13.4	18.6	—	.218
14	7	11 1/2	11.6	14.9	20.7	—	.253
12	8	11 1/2	11.2	14.4	20.0	26.1	.275
14	8	11 1/2	12.4	16.0	22.2	29.1	.325
16	8	11 1/2	13.7	17.6	24.5	32.0	.375
18	8	11 1/2	14.9	19.2	26.7	35.0	.420

## AC Welded Steel

High front for greater capacity. Hooded back for closer spacing. Typical in cement, gypsum powder or other powdery materials. Venting available for clean filling and discharge. Mounted on chain or belt.

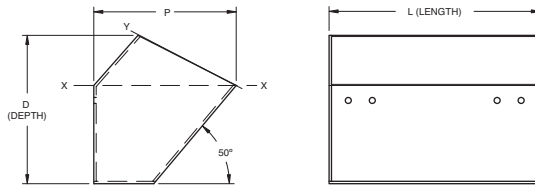

\*Weights do not include bolt reinforcing plates. Bolt reinforcing plates are recommended if less than 8 bolts are used. Vent holes in bottom are optional in style "AC" buckets.

Bucket Size, Inches			Weight		Cap. Cu. Feet^	
L Length	P Proj.	D Depth	3/16" Steel	1/4" Steel	Filled to Line X-X	Filled to Line X-Y
12	8	8 1/2	18.25	24.30	.231	.303
14	8	8 1/2	20.30	27.00	.271	.356
16	8	8 1/2	22.48	29.98	.311	.408
18	10	10 1/2	31.15	38.95	.488	.691
20	10	10 1/2	33.68	42.10	.542	.768
24	10	10 1/2	39.67	52.69	.651	.921
27	12	12 1/2	53.84	71.46	1.072	1.474

## SC Welded Steel

Mounted between two strands of chain. Suitable for the heaviest materials. Designed for super capacity elevators. Typical in asphalt and concrete applications. Design offers increased capacity.

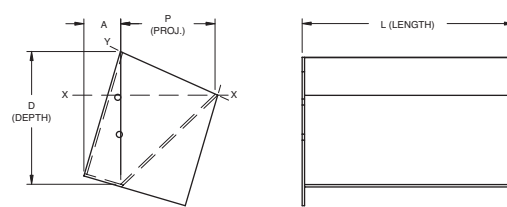

\*Note: Actual capacity depends on angle of repose of material handled and inclination of elevator.

Bucket Size, Inches				Weight				Cap. Cu. Feet^	
L Length	P Proj.	D Depth	A Inches	10 Gauge Steel	3/16" Steel	1/4" Steel	5/16" Steel	Filled to Line X-X	Filled to Line X-Y
12	8 1/4	11 1/8	4 1/16	22	29	39	49	.35	.54
14	8 1/4	11 1/8	4 1/16	23	31	41	51	.41	.63
16	8 1/4	11 1/8	4 1/16	25	34	45	56	.46	.72
16	12	17 1/8	6 1/2	43	58	76	95	1.11	1.55
18	8 1/4	11 1/8	4 1/16	27	36	48	60	.52	.81
20	8 1/4	11 1/8	4 1/16	29	39	52	65	.58	.90
20	12	17 1/8	6 1/2	49	67	88	110	1.40	1.94
24	12	17 1/8	6 1/2	55	75	104	130	1.68	2.33
30	12	17 1/8	6 1/2	65	88	117	146	2.11	2.91
36	12	17 1/8	6 1/2	73	99	132	165	2.53	3.49

## Chain

Combination chains, C-, have cast block links and steel connecting side bars. All steel (steel knuckle), SS, are fabricated of steel. Attachments are available either on the connecting side bars or block link.

Chain No.	Pitch in Inches	Average Ultimate Strength Lbs.	Rated Working Value Lbs.	Wt. Per Ft. Lbs Attachment Every Other Pitch	Attachment Number	Dimension in Inches		
						Pin Diameter	Side Bar	Barrel or Knuckle Dia.
C-977	2.308	11,000	1830	2.2	K-1	7/16	3/16 x 7/8	7/8
C-188	2.609	14,000	1950	4.8	K-2	1/2	1/4 x 1 1/8	7/8
C-102B	4.0	24,000	4000	7.8	K-2	5/8	3/8 x 1 1/2	1 1/32
C-110	6.0	24,000	4000	7.3	K-2	3/4	3/8 x 1 1/2	1 1/16
C-111	4.76	36,000	5,950	10.7	K-2	3/4	3/8 x 1 3/4	1 15/32
SS-102B	4.0	40,000	6,290	9.0	K-2	5/8	3/8 x 1 1/2	1
SS-110	6.0	40,000	6290	8.6	K-2	3/4	3/8 x 1 1/2	1 1/4

NOTE: All dimensions are inside to inside of bucket.



# Bucket Punching (Belt)

CEMA Standard (Formerly P1 thru P9)

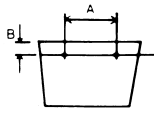

B1

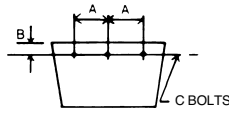

B2

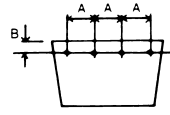

B3

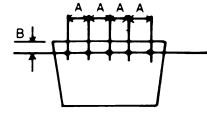

B4

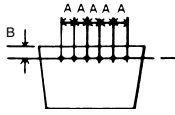

B5

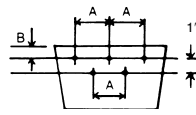

B6

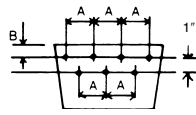

B7

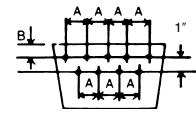

B8

Bucket Length	Salem and Other Similar Light Buckets				M.I. & Steel Buckets Style A, AA, AA-RB, B, C, etc.				Continuous Buckets			
	Punch	A	B	C*	Punch	A	B	C*	Punch	A	B	C*
6	B-1	4 <sup>3</sup> / <sub>8</sub>	5 <sup>1</sup> / <sub>8</sub>	1 <sup>1</sup> / <sub>4</sub>	B-1	4- <sup>3</sup> / <sub>8</sub>	1	1 <sup>1</sup> / <sub>4</sub>	—	—	—	—
8	B-2	3 <sup>1</sup> / <sub>16</sub>	7 <sup>1</sup> / <sub>8</sub>	1 <sup>1</sup> / <sub>4</sub> - <sup>5</sup> / <sub>16</sub>	B-6	3	7 <sup>1</sup> / <sub>8</sub>	1 <sup>1</sup> / <sub>4</sub> - <sup>5</sup> / <sub>16</sub>	B-6	3	DEPTH 1 2	1 <sup>1</sup> / <sub>4</sub> - <sup>5</sup> / <sub>16</sub>
10	B-2	4 <sup>1</sup> / <sub>8</sub>	7 <sup>1</sup> / <sub>8</sub>	1 <sup>1</sup> / <sub>4</sub> - <sup>5</sup> / <sub>16</sub>	B-6	3 <sup>1</sup> / <sub>2</sub>	7 <sup>1</sup> / <sub>8</sub>	1 <sup>1</sup> / <sub>4</sub> - <sup>5</sup> / <sub>16</sub>	B-6	3 <sup>1</sup> / <sub>2</sub>		1 <sup>1</sup> / <sub>4</sub> - <sup>5</sup> / <sub>16</sub>
12	B-3	3 <sup>3</sup> / <sub>8</sub>	7 <sup>1</sup> / <sub>8</sub>	1 <sup>1</sup> / <sub>4</sub> - <sup>5</sup> / <sub>16</sub>	B-6	4 <sup>1</sup> / <sub>2</sub>	7 <sup>1</sup> / <sub>8</sub>	1 <sup>1</sup> / <sub>4</sub> - <sup>5</sup> / <sub>16</sub>	B-6	4 <sup>1</sup> / <sub>2</sub>		1 <sup>1</sup> / <sub>4</sub> - <sup>5</sup> / <sub>16</sub>
14	B-4	3	7 <sup>1</sup> / <sub>8</sub>	1 <sup>1</sup> / <sub>4</sub> - <sup>5</sup> / <sub>16</sub>	B-7	4	7 <sup>1</sup> / <sub>8</sub>	5 <sup>1</sup> / <sub>16</sub>	B-7	4		5 <sup>1</sup> / <sub>16</sub>
16	B-5	2 <sup>7</sup> / <sub>8</sub>	7 <sup>1</sup> / <sub>8</sub>	1 <sup>1</sup> / <sub>4</sub> - <sup>5</sup> / <sub>16</sub>	B-7	4 <sup>1</sup> / <sub>2</sub>	7 <sup>1</sup> / <sub>8</sub>	5 <sup>1</sup> / <sub>16</sub>	B-7	4 <sup>1</sup> / <sub>2</sub>		5 <sup>1</sup> / <sub>16</sub>
18	—	—	—	—	—	—	—	—	B-7	5	5 <sup>1</sup> / <sub>16</sub>	

\*C = Bolt Diameter. See Chart on Page H-142.

## Bucket Punching — Chain

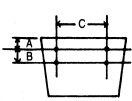

Style AA, C, SC, etc.

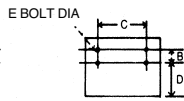

Continuous

Chain Number	Attachment Number	A	B	C	D	E
C-977	K-1	1	—	3	—	5 <sup>1</sup> / <sub>8</sub>
C-188	K-2	1	1 <sup>1</sup> / <sub>4</sub>	4 <sup>3</sup> / <sub>16</sub>	2 <sup>3</sup> / <sub>4</sub>	5 <sup>1</sup> / <sub>8</sub>
C-102B	K-2	3 <sup>1</sup> / <sub>4</sub>	1 <sup>3</sup> / <sub>4</sub>	5 <sup>5</sup> / <sub>16</sub>	2	5 <sup>1</sup> / <sub>8</sub>
C-110	K-2	7 <sup>1</sup> / <sub>8</sub>	1 <sup>3</sup> / <sub>4</sub>	5 <sup>5</sup> / <sub>16</sub>	3 <sup>3</sup> / <sub>8</sub>	5 <sup>1</sup> / <sub>8</sub>
C-111	K-2	3 <sup>1</sup> / <sub>4</sub>	2 <sup>5</sup> / <sub>16</sub>	6 <sup>1</sup> / <sub>4</sub>	2 <sup>1</sup> / <sub>2</sub>	5 <sup>1</sup> / <sub>8</sub>
SS-102B	K-2	3 <sup>1</sup> / <sub>4</sub>	1 <sup>3</sup> / <sub>4</sub>	5 <sup>5</sup> / <sub>16</sub>	2	5 <sup>1</sup> / <sub>8</sub>
SS-110	K-2	7 <sup>1</sup> / <sub>8</sub>	1 <sup>3</sup> / <sub>4</sub>	5 <sup>5</sup> / <sub>16</sub>	3 <sup>3</sup> / <sub>8</sub>	5 <sup>1</sup> / <sub>8</sub>

Bucket Size	High Speed Grain			
	Punch	A	B	C
7 x 5	B2	2 <sup>1</sup> / <sub>16</sub>	1 <sup>3</sup> / <sub>4</sub>	1 <sup>1</sup> / <sub>4</sub>
9 x 5	B2	3 <sup>3</sup> / <sub>8</sub>	1 <sup>3</sup> / <sub>4</sub>	1 <sup>1</sup> / <sub>4</sub>
9 x 6	B2	3 <sup>3</sup> / <sub>8</sub>	2	1 <sup>1</sup> / <sub>4</sub>
11 x 6	B3	3	2	1 <sup>1</sup> / <sub>4</sub>
12 x 6	B3	3 <sup>3</sup> / <sub>8</sub>	2	1 <sup>1</sup> / <sub>4</sub>
14 x 7	B4	3	2	5 <sup>1</sup> / <sub>16</sub>

Consult *Martin* for "AC" and "SC" Bucket Punching.

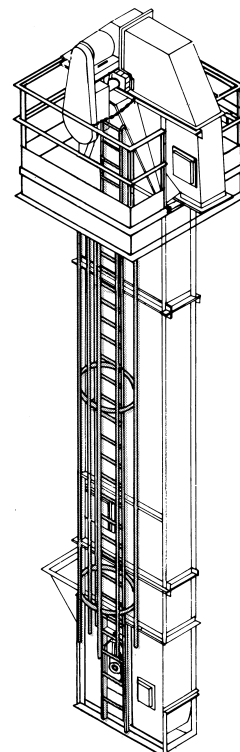

### Platforms

Head section service platforms are of structural steel, angle hand rails and heavy non-skid grating. The platform mounts securely to the elevator head section. Various sizes and configurations are available. Rest platforms are also available and required at 30' intervals.

### Ladders/Safety Cages

Ladders with safety cages are available. They are constructed of heavy gauge steel and sized to provide easy access to platforms. Ladders with safety cage are easily bolted to the elevator casings.

CONVEYORS

# Formulas for Calculating Number of Buckets, Bucket Bolts, Washers and Length of Chain or Belt



## Centrifugal Discharge Chain Series 100

Number of Buckets, Bucket Bolts, Washers and Length of Chain.

Elevator Number	Buckets Style AA Malleable			Bucket Bolts and Lock Washers Hex Head Cap Screws		Chain		
	Size (Inches)	Spacing (Inches)	Quantity	Size (Inches)	Quantity	Number	Attachment Every Link	Length (Feet)
C43-101	4 x 3	9/4	1.5 + (2.58 x Shaft Ctrs)	1/4 x 1	2 x (No. of Buckets)	C-77	K1-4th	2.31' + (2 x Shaft Ctrs)
C64-102	6 x 4	13	4.4 + (1.85 x Shaft Ctrs)	1/4 x 1	2 x (No. of Buckets)	C-188	K1-5th	4.79' + (2 x Shaft Ctrs)
C85-103	8 x 5	16	2.75 + (1.5 x Shaft Ctrs)	3/8 x 1 1/4	4 x (No. of Buckets)	C-102B	K2-4th	3.66' + (2 x Shaft Ctrs)
C85-104	8 x 5	16	3.5 + (1.5 x Shaft Ctrs)	3/8 x 1 1/4	4 x (No. of Buckets)	C-102B	K2-4th	4.66' + (2 x Shaft Ctrs)
C85-105	8 x 5	16	3.5 + (1.5 x Shaft Ctrs)	3/8 x 1 1/4	4 x (No. of Buckets)	SS-102B	K2-4th	4.66' + (2 x Shaft Ctrs)
C85-107	8 x 5	16	4.25 + (1.5 x Shaft Ctrs)	3/8 x 1 1/4	4 x (No. of Buckets)	C-102B	K2-4th	5.66' + (2 x Shaft Ctrs)
C85-108	8 x 5	16	4.25 + (1.5 x Shaft Ctrs)	3/8 x 1 1/4	4 x (No. of Buckets)	SS-102B	K2-4th	5.66' + (2 x Shaft Ctrs)
C106-110	10 x 6	16	3.75 + (1.5 x Shaft Ctrs)	3/8 x 1 1/4	4 x (No. of Buckets)	C-102B	K2-4th	5.0' + (2 x Shaft Ctrs)
C106-111	10 x 6	16	3.75 + (1.5 x Shaft Ctrs)	3/8 x 1 1/4	4 x (No. of Buckets)	SS-102B	K2-4th	5.0' + (2 x Shaft Ctrs)
C106-112	10 x 6	18	4.33 + (1.33 x Shaft Ctrs)	3/8 x 1 1/4	4 x (No. of Buckets)	C-110	K2-3rd	6.5' + (2 x Shaft Ctrs)
C106-113	10 x 6	18	4.33 + (1.33 x Shaft Ctrs)	3/8 x 1 1/4	4 x (No. of Buckets)	SS-110	K2-3rd	6.5' + (2 x Shaft Ctrs)
C106-116	10 x 6	18	4.5 + (1.5 x Shaft Ctrs)	3/8 x 1 1/4	4 x (No. of Buckets)	C-102B	K2-3rd	6.0' + (2 x Shaft Ctrs)
C127-117	12 x 7	18	4.0 + (1.33 x Shaft Ctrs)	3/8 x 1 1/4	4 x (No. of Buckets)	SS-110	K2-3rd	6.0' + (2 x Shaft Ctrs)
C127-119	12 x 7	16	4.25 + (1.5 x Shaft Ctrs)	3/8 x 1 1/4	4 x (No. of Buckets)	C-102B	K2-4th	5.66' + (2 x Shaft Ctrs)
C127-120	12 x 7	18	5.0 + (1.33 x Shaft Ctrs)	3/8 x 1 1/4	4 x (No. of Buckets)	SS-110	K2-3rd	7.5' + (2 x Shaft Ctrs)
C127-122	12 x 7	16	5.5 + (1.5 x Shaft Ctrs)	3/8 x 1 1/4	4 x (No. of Buckets)	C-102B	K2-4th	7.33' + (2 x Shaft Ctrs)
C147-123	14 x 7	19	3.79 + (1.26 x Shaft Ctrs)	1/2 x 1 1/4	4 x (No. of Buckets)	C-111	K2-4th	6.0' + (2 x Shaft Ctrs)
C147-124	14 x 7	18	4.0 + (1.33 x Shaft Ctrs)	3/8 x 1 1/4	4 x (No. of Buckets)	SS-110	K2-4th	6.0' + (2 x Shaft Ctrs)
C147-126	14 x 7	16	4.25 + (1.5 x Shaft Ctrs)	3/8 x 1 1/4	4 x (No. of Buckets)	C-102B	K2-4th	5.66' + (2 x Shaft Ctrs)
C147-127	14 x 7	19	4.74 + (1.26 x Shaft Ctrs)	1/2 x 1 1/4	4 x (No. of Buckets)	C-111	K2-4th	7.5' + (2 x Shaft Ctrs)
C147-128	14 x 7	18	5.0 + (1.33 x Shaft Ctrs)	3/8 x 1 1/4	4 x (No. of Buckets)	K2-3rd	K2-3rd	7.5' + (2 x Shaft Ctrs)
C147-130	14 x 7	16	5.5 + (1.5 x Shaft Ctrs)	3/8 x 1 1/4	4 x (No. of Buckets)	SS-102B	K2-4th	7.33' + (2 x Shaft Ctrs)
C168-131	16 x 8	19	3.48 + (1.26 x Shaft Ctrs)	1/2 x 1 1/4	4 x (No. of Buckets)	C-111	K2-4th	5.55' + (2 x Shaft Ctrs)
C168-132	16 x 8	18	3.66 + (1.33 x Shaft Ctrs)	3/8 x 1 1/4	4 x (No. of Buckets)	SS-110	K2-3rd	5.55' + (2 x Shaft Ctrs)
C168-133	16 x 8	19	4.51 + (1.26 x Shaft Ctrs)	1/2 x 1 1/4	4 x (No. of Buckets)	C-111	K2-4th	7.13' + (2 x Shaft Ctrs)
C168-134	16 x 8	18	4.66 + (1.33 x Shaft Ctrs)	3/8 x 1 1/4	4 x (No. of Buckets)	SS-110	K2-3rd	7.0' + (2 x Shaft Ctrs)

## Centrifugal Discharge Belt Series 100

Number of Buckets, Bucket Bolts, Washers and Length of Belt.

Elevator Number	Buckets Style AA Malleable			Bucket Bolts and Lock Washers (Norway Elevator Bolts)		Belt (Including 3 Buckets Overlap)	
	Size (Inches)	Spacing (Inches)	Quantity	Size (Inches)	Quantity	No. of Holes to be Punched in Belt	Length (Feet)
B43-139	4 x 3	8	3.12 + (3 x Shaft Ctrs)	1/4 x 1	2 x (No. of Buckets)	6 + (No. of Bolts)	5' + (2 x Shaft Ctrs)
B64-140	6 x 4	13	4.85 + (1.85 x Shaft Ctrs)	1/4 x 1	2 x (No. of Buckets)	6 + (No. of Bolts)	9' + (2 x Shaft Ctrs)
B64-141	6 x 4	13	4.34 + (1.85 x Shaft Ctrs)	1/4 x 1	2 x (No. of Buckets)	6 + (No. of Bolts)	9' + (2 x Shaft Ctrs)
B85-142	8 x 5	16	3.34 + (1.5 x Shaft Ctrs)	3/8 x 1 1/4	5 x (No. of Buckets)	15 + (No. of Bolts)	9' + (2 x Shaft Ctrs)
B85-143	8 x 5	16	4.13 + (1.5 x Shaft Ctrs)	3/8 x 1 1/4	5 x (No. of Buckets)	15 + (No. of Bolts)	10' + (2 x Shaft Ctrs)
B106-144	10 x 6	16	3.53 + (1.5 x Shaft Ctrs)	3/8 x 1 1/4	5 x (No. of Buckets)	15 + (No. of Bolts)	9' + (2 x Shaft Ctrs)
B106-145	10 x 6	16	4.34 + (1.5 x Shaft Ctrs)	3/8 x 1 1/4	5 x (No. of Buckets)	15 + (No. of Bolts)	10' + (2 x Shaft Ctrs)
B127-146	12 x 7 Staggered	18	3.86 + (1.33 x Shaft Ctrs)	3/8 x 1 1/2	5 x (No. of Buckets)	15 + (No. of Bolts)	11' + (2 x Shaft Ctrs)
B127-146S	12 x 7	16	6.28 + (3 x Shaft Ctrs)	3/8 x 1 1/2	5 x (No. of Buckets)	15 + (No. of Bolts)	15' + (2 x Shaft Ctrs)
B127-147	12 x 7	18	4.72 + (1.33 x Shaft Ctrs)	3/8 x 1 1/2	5 x (No. of Buckets)	15 + (No. of Bolts)	13' + (2 x Shaft Ctrs)
B147-148	14 x 7	18	3.86 + (1.33 x Shaft Ctrs)	3/8 x 1 1/2	7 x (No. of Buckets)	21 + (No. of Bolts)	11' + (2 x Shaft Ctrs)
B147-149	14 x 7	18	4.72 + (1.33 x Shaft Ctrs)	3/8 x 1 1/2	7 x (No. of Buckets)	21 + (No. of Bolts)	13' + (2 x Shaft Ctrs)
B168-150	16 x 8	18	3.31 + (1.33 x Shaft Ctrs)	3/8 x 1 1/2	7 x (No. of Buckets)	21 + (No. of Bolts)	10' + (2 x Shaft Ctrs)
B168-152	16 x 8	18	4.72 + (1.33 x Shaft Ctrs)	3/8 x 1 1/2	7 x (No. of Buckets)	21 + (No. of Bolts)	13' + (2 x Shaft Ctrs)

## Continuous Discharge Chain Series 700

Number of Buckets, Bucket Bolts, Washers and Length of Chain.

Elevator Number	Buckets Medium Front Continuous Steel Buckets			Bucket Bolts and Lock Washers Hex Head Cap Screws		Chain		
	Size (Inches)	Spacing (Inches)	Quantity	Size (Inches)	Quantity	Number	Attachment Every Link	Length (Feet)
C85-766	8 x 5 x 7 1/4	8	6.57 + (3 x Shaft Ctrs)	3/8 x 1 1/4	4 x (No. of Buckets)	C-102B	K2-2nd	4.66' + (2 x Shaft Ctrs)
C85-767	8 x 5 x 7 1/4	8	6.57 + (3 x Shaft Ctrs)	3/8 x 1 1/4	4 x (No. of Buckets)	SS-102B	K2-2nd	4.66' + (2 x Shaft Ctrs)
C105-768	10 x 5 x 7 1/4	8	8.25 + (3 x Shaft Ctrs)	3/8 x 1 1/4	4 x (No. of Buckets)	C-102B	K2-2nd	5.0' + (2 x Shaft Ctrs)
C105-769	10 x 5 x 7 1/4	8	8.25 + (3 x Shaft Ctrs)	3/8 x 1 1/4	4 x (No. of Buckets)	SS-102B	K2-2nd	5.0' + (2 x Shaft Ctrs)
C107-770	10 x 7 x 11 1/2	12	6.06 + (2 x Shaft Ctrs)	3/8 x 1 1/4	4 x (No. of Buckets)	C-110	K2-2nd	6.5' + (2 x Shaft Ctrs)
C107-771	10 x 7 x 11 1/2	12	6.06 + (2 x Shaft Ctrs)	3/8 x 1 1/4	4 x (No. of Buckets)	SS-110	K2-2nd	6.5' + (2 x Shaft Ctrs)
C127-772	12 x 7 x 11 1/2	12	5.60 + (2 x Shaft Ctrs)	3/8 x 1 1/4	4 x (No. of Buckets)	C-110	K2-2nd	6.0' + (2 x Shaft Ctrs)
C127-773	12 x 7 x 11 1/2	12	5.60 + (2 x Shaft Ctrs)	3/8 x 1 1/4	4 x (No. of Buckets)	SS-110	K2-2nd	6.0' + (2 x Shaft Ctrs)
C147-774	14 x 7 x 11 1/2	12	5.60 + (2 x Shaft Ctrs)	3/8 x 1 1/4	4 x (No. of Buckets)	C-110	K2-2nd	6.0' + (2 x Shaft Ctrs)
C147-775	14 x 7 x 11 1/2	12	5.60 + (2 x Shaft Ctrs)	3/8 x 1 1/4	4 x (No. of Buckets)	SS-110	K2-2nd	6.0' + (2 x Shaft Ctrs)
C128-776	12 x 8 x 11 1/2	12	5.60 + (2 x Shaft Ctrs)	3/8 x 1 1/4	4 x (No. of Buckets)	C-110	K2-2nd	6.0' + (2 x Shaft Ctrs)
C128-777	12 x 8 x 11 1/2	12	5.60 + (2 x Shaft Ctrs)	3/8 x 1 1/4	4 x (No. of Buckets)	SS-110	K2-2nd	6.0' + (2 x Shaft Ctrs)
C148-778	14 x 8 x 11 1/2	12	5.60 + (2 x Shaft Ctrs)	3/8 x 1 1/4	4 x (No. of Buckets)	C-110	K2-2nd	6.0' + (2 x Shaft Ctrs)
C148-779	14 x 8 x 11 1/2	12	5.60 + (2 x Shaft Ctrs)	3/8 x 1 1/4	4 x (No. of Buckets)	SS-110	K2-2nd	6.0' + (2 x Shaft Ctrs)
C168-781	16 x 8 x 11 1/2	12	5.33 + (2 x Shaft Ctrs)	3/8 x 1 1/4	4 x (No. of Buckets)	SS-110	K2-2nd	5.5' + (2 x Shaft Ctrs)
C168-783	16 x 8 x 11 1/2	12	5.33 + (2 x Shaft Ctrs)	3/8 x 1 1/4	4 x (No. of Buckets)	SS-110	K2-2nd	5.5' + (2 x Shaft Ctrs)

## Continuous Discharge Belt Series 700

Number of Buckets, Bucket Bolts, Washers and Length of Chain.

Elevator Number	Buckets Medium Front Continuous Steel Buckets			Bucket Bolts and Lock Washers (Norway Elevator Bolts)		Belt (Including 3 Buckets Overlap)		
	Size (Inches)	Spacing (Inches)	Quantity	Size (Inches)	Quantity	Width (Inches)	No. of Holes to be Punched in Belt	Length (Feet)
B85-790	8 x 5 x 7 1/4	8	7.88 + (3 x Shaft Ctrs)	1/4 x 3/4	5 x (No. of Buckets)	9	15 + (No. of Bolts)	8' + (2 x Shaft Ctrs)
B105-791	10 x 5 x 7 1/4	8	6.5 + (3 x Shaft Ctrs)	3/8 x 1	5 x (No. of Buckets)	11	15 + (No. of Bolts)	7' + (2 x Shaft Ctrs)
B107-792	10 x 7 x 11 1/2	12	5.75 + (2 x Shaft Ctrs)	3/8 x 1	5 x (No. of Buckets)	11	15 + (No. of Bolts)	10' + (2 x Shaft Ctrs)
B127-793	12 x 7 x 11 1/2	12	5.75 + (2 x Shaft Ctrs)	3/8 x 1 1/4	5 x (No. of Buckets)	13	15 + (No. of Bolts)	10' + (2 x Shaft Ctrs)
B147-794	14 x 7 x 11 1/2	12	5.75 + (2 x Shaft Ctrs)	3/8 x 1 1/4	7 x (No. of Buckets)	15	21 + (No. of Bolts)	10' + (2 x Shaft Ctrs)
B128-795	12 x 8 x 11 1/2	12	5.75 + (2 x Shaft Ctrs)	3/8 x 1 1/4	5 x (No. of Buckets)	13	15 + (No. of Bolts)	10' + (2 x Shaft Ctrs)
B148-796	14 x 8 x 11 1/2	12	5.75 + (2 x Shaft Ctrs)	3/8 x 1 1/4	7 x (No. of Buckets)	15	21 + (No. of Bolts)	10' + (2 x Shaft Ctrs)
B168-797	16 x 8 x 11 1/2	12	5.75 + (2 x Shaft Ctrs)	3/8 x 1 1/4	7 x (No. of Buckets)	17	21 + (No. of Bolts)	10' + (2 x Shaft Ctrs)
B163-798	16 x 8 x 11 1/2	12	4.96 + (2 x Shaft Ctrs)	3/8 x 1 1/4	7 x (No. of Buckets)	19	21 + (No. of Bolts)	9' + (2 x Shaft Ctrs)

\* If answer is a fraction, go to next whole number. Consult *Martin* for units not shown.



# High Speed Grain Centrifugal Discharge Belt Series 500

Elevator Number	Maximum Capacity		Bucket <sup>1</sup>		Head Shaft RPM	Pulley		Belt		Maximum Centers (Ft.)				
	BPH ◀	CFH <sup>2</sup>	Size	Spacing		Dia. <sup>1</sup>	Face <sup>1</sup>	Width <sup>1</sup>	FPM	Head Shaft Diameter <sup>1</sup>				
										1 <sup>1</sup> / <sub>16</sub>	2 <sup>1</sup> / <sub>16</sub>	2 <sup>1</sup> / <sub>8</sub>	2 <sup>1</sup> / <sub>4</sub>	3 <sup>1</sup> / <sub>16</sub>
B75-506	1580	1965	7 × 5	8	80	24	9	8	502	65	85	112	—	—
B75-508	1800	2240	7 × 5	7	80	24	9	8	502	60	85	112	—	—
B95-514	2438	3033	9 × 5	8	75	30	11	10	589	40	75	88	140	—
B95-515	2779	3458	9 × 5	7	75	30	11	10	589	40	65	85	130	—
B96-526	3969	4937	9 × 6	8	70	36	11	10	659	34	70	90	110	—
B96-528	4524	5628	9 × 6	7	70	36	11	10	659	30	60	80	95	—
B116-536	4372	5438	11 × 6	9	70	36	13	12	659	—	—	52	83	140
B116-538	4930	6134	11 × 6	8	70	36	13	12	659	—	—	50	80	130
B126-546	4800	5971	12 × 6	9	70	36	14	13	659	—	—	45	75	125
B126-548	5413	6734	12 × 6	8	70	36	14	13	659	—	—	45	75	125
B147-556	7111	8846	14 × 7	10	63	42	16	15	659	—	—	30	50	90
B147-558	7881	9805	14 × 7	9	63	42	16	15	659	—	—	25	40	85

<sup>1</sup>Dimensions are in inches. <sup>2</sup>BPH × 1.24 = CFH. ◀ Based on 75% full bucket.

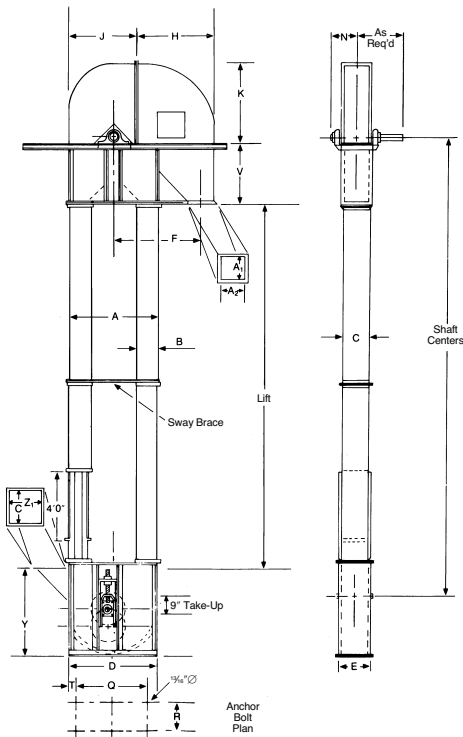

Elevator Number	Dimensions <sup>1</sup> (In Inches)																	Boot Shaft Diameter		
	A	B	C	D	E	F	H	J	K	N*	Q	R	T	V	W	Y	Z <sub>1</sub>		A <sub>1</sub>	A <sub>2</sub>
B75-506 and B75-508	41	9 <sup>1</sup> / <sub>2</sub>	11	44	14	38 <sup>1</sup> / <sub>2</sub>	33 <sup>1</sup> / <sub>2</sub>	30 <sup>3</sup> / <sub>4</sub>	34 <sup>1</sup> / <sub>2</sub>	9	32	12 <sup>3</sup> / <sub>4</sub>	6	23 <sup>1</sup> / <sub>2</sub>	20	40	12 <sup>1</sup> / <sub>2</sub>	11	10	1 <sup>1</sup> / <sub>2</sub>
B95-514 and B95-515	47	11	13	50	16	46 <sup>1</sup> / <sub>2</sub>	41	35 <sup>1</sup> / <sub>2</sub>	41 <sup>1</sup> / <sub>2</sub>	10	38	14 <sup>3</sup> / <sub>4</sub>	6	29 <sup>1</sup> / <sub>2</sub>	22	45	15 <sup>1</sup> / <sub>2</sub>	13	13	1 <sup>1</sup> / <sub>2</sub>
B96-526 and B96-528	49	11	13	52	16	47 <sup>1</sup> / <sub>2</sub>	42	36 <sup>1</sup> / <sub>2</sub>	42 <sup>1</sup> / <sub>2</sub>	13	40	14 <sup>3</sup> / <sub>4</sub>	6	29 <sup>1</sup> / <sub>2</sub>	22	45	15 <sup>1</sup> / <sub>2</sub>	13	13	1 <sup>1</sup> / <sub>2</sub>
B116-536 and B116-538	56	12 <sup>1</sup> / <sub>2</sub>	15	59	18	56 <sup>1</sup> / <sub>2</sub>	47 <sup>1</sup> / <sub>2</sub>	44 <sup>1</sup> / <sub>2</sub>	49 <sup>1</sup> / <sub>2</sub>	13	47	16 <sup>3</sup> / <sub>4</sub>	6	35 <sup>1</sup> / <sub>2</sub>	27	51	19	15	15	2
B126-546 and B126-548	56	12 <sup>1</sup> / <sub>2</sub>	16	59	19	56 <sup>1</sup> / <sub>2</sub>	47 <sup>1</sup> / <sub>2</sub>	44 <sup>1</sup> / <sub>2</sub>	49 <sup>1</sup> / <sub>2</sub>	13	47	17 <sup>3</sup> / <sub>4</sub>	6	35 <sup>1</sup> / <sub>2</sub>	27	51	19	16	15	2
B147-556 and B147-558	63	13	18	65	21	68 <sup>1</sup> / <sub>2</sub>	53	55 <sup>1</sup> / <sub>2</sub>	57 <sup>1</sup> / <sub>2</sub>	15	52	19 <sup>3</sup> / <sub>4</sub>	6	41 <sup>1</sup> / <sub>2</sub>	33	57	25 <sup>1</sup> / <sub>2</sub>	18	17	2

\*Approximate. <sup>1</sup>Not certified for construction.

CONVEYORS



# Drag Conveyors



## Drag Conveyors Section VII

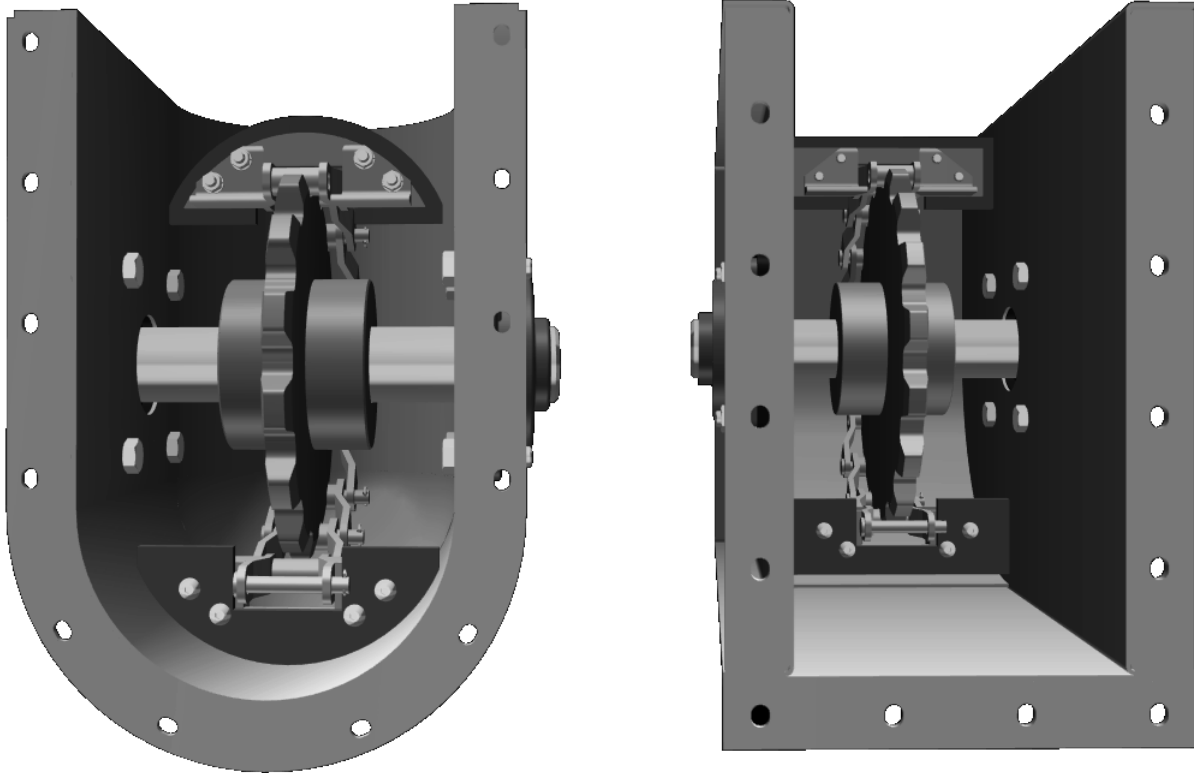

### SECTION VII

#### DRAG CONVEYOR SECTION VII

Safety .....	H-145
Round Bottom Drag Conveyor .....	H-146
Flat Bottom Drag Conveyor .....	H-149
L & S Path Drag Conveyor .....	H-153

CONVEYORS





# Safety



## WARNING AND SAFETY REMINDERS FOR SCREW, DRAG, AND BUCKET ELEVATOR CONVEYORS

APPROVED FOR DISTRIBUTION BY THE SCREW CONVEYOR SECTION OF THE CONVEYOR EQUIPMENT MANUFACTURERS ASSOCIATION (CEMA)

It is the responsibility of the contractor, installer, owner and user to install, maintain and operate the conveyor, components and, conveyor assemblies in such a manner as to comply with the Williams-Steiger Occupational Safety and Health Act and with all state and local laws and ordinances and the American National Standards Institute (ANSI) B20.1 Safety Code.

In order to avoid an unsafe or hazardous condition, the assemblies or parts must be installed and operated in accordance with the following minimum provisions.

1. Conveyors shall not be operated unless all covers and/or guards for the conveyor and drive unit are in place. If the conveyor is to be opened for inspection cleaning, maintenance or observation, the electric power to the motor driving the conveyor must be LOCKED OUT in such a manner that the conveyor cannot be restarted by anyone; however remote from the area, until conveyor cover or guards and drive guards have been properly replaced.
2. If the conveyor must have an open housing as a condition of its use and application, the entire conveyor is then to be guarded by a railing or fence in accordance with ANSI standard B20.1. (Request current edition and addenda)
3. Feed openings for shovel, front loaders or other manual or mechanical equipment shall be constructed in such a way that the conveyor opening is covered by a grating. If the nature of the material is such that a grating cannot be used, then the exposed section of the conveyor is to be guarded by a railing or fence and there shall be a warning sign posted.
4. Do not attempt any maintenance or repairs of the conveyor until power has been LOCKED OUT.
5. Always operate conveyor in accordance with these instructions and those contained

on the caution labels affixed to the equipment.

6. Do not place hands, feet, or any part of your body, in the conveyor.
7. Never walk on conveyor covers, grating or guards.
8. Do not use conveyor for any purpose other than that for which it was intended.
9. Do not poke or prod material into the conveyor with a bar or stick inserted through the openings.
10. Keep area around conveyor drive and control station free of debris and obstacles.
11. Eliminate all sources of stored energy (materials or devices that could cause conveyor components to move without power applied) before opening the conveyor
12. Do not attempt to clear a jammed conveyor until power has been LOCKED OUT.
13. Do not attempt field modification of conveyor or components.
14. Conveyors are not normally manufactured or designed to handle materials that are hazardous to personnel. These materials which are hazardous include those that are explosive, flammable, toxic or otherwise dangerous to personnel. Conveyors may be designed to handle these materials. Conveyors are not manufactured or designed to comply with local, state or federal codes for unfired pressure vessels. If hazardous materials are to be conveyed or if the conveyor is to be subjected to internal or external pressure, manufacturer should be consulted prior to any modifications.

CEMA insists that disconnecting and locking out the power to the motor driving the unit provides the only real protection against injury. Secondary safety devices are available; however, the decision as to their need and the type required must be made by the owner-assembler as we have no information regarding plant wiring, plant environment, the interlocking of the screw conveyor with other equipment, extent of plant automation, etc. Other devices should not be used as a substitute for locking out the power prior to removing guards or covers. We caution that use of the secondary devices may cause employees to develop a false sense of security and fail to lock out power before removing covers or guards. This could result in a serious injury should the secondary device fail or malfunction.

There are many kinds of electrical devices for interlocking of conveyors and conveyor systems such that if one conveyor in a system or process is stopped other equipment feeding it, or following it can also be automatically stopped.

Electrical controls, machinery guards, railings, walkways, arrangement of installation, training of personnel, etc., are necessary ingredients for a safe working place. It is the responsibility of the contractor, installer, owner and user to supplement the materials and services furnished with these necessary items to make the conveyor installation comply with the law and accepted standards.

Conveyor inlet and discharge openings are designed to connect to other equipment or machinery so that the flow of material into and out of the conveyor is completely enclosed.

One or more warning labels should be visible on conveyor housings, conveyor covers and elevator housings. If the labels attached to the equipment become illegible, please order replacement warning labels from the OEM or CEMA.

The Conveyor Equipment Manufacturers Association (CEMA) has produced an audio-visual presentation entitled "Safe Operation of Screw Conveyors, Drag Conveyors, and Bucket Elevators." CEMA encourages acquisition and use of this source of safety information to supplement your safety program.



PROMINENTLY DISPLAY THESE SAFETY LABELS ON INSTALLED EQUIPMENT

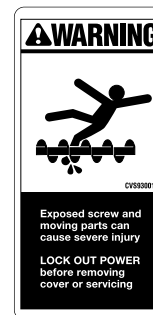
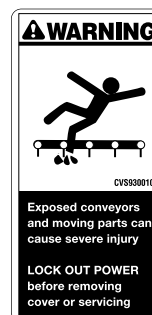

NOTICE: This document is provided by CEMA as a service to the industry in the interest of promoting safety. It is advisory only and it is not a substitute for a thorough safety program. Users should consult with qualified engineers and other safety professionals. CEMA makes no representations or warranties, either expressed or implied, and the users of this document assume full responsibility for the safe design and operation of equipment.

CONVEYORS

# Round Bottom Drag Conveyor

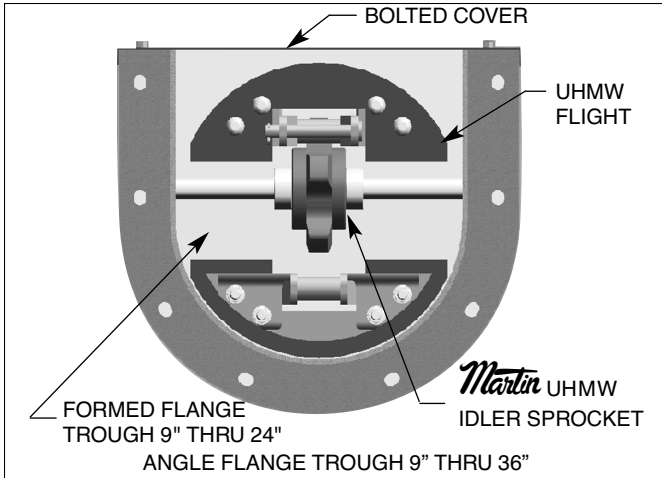

**Idler Return**

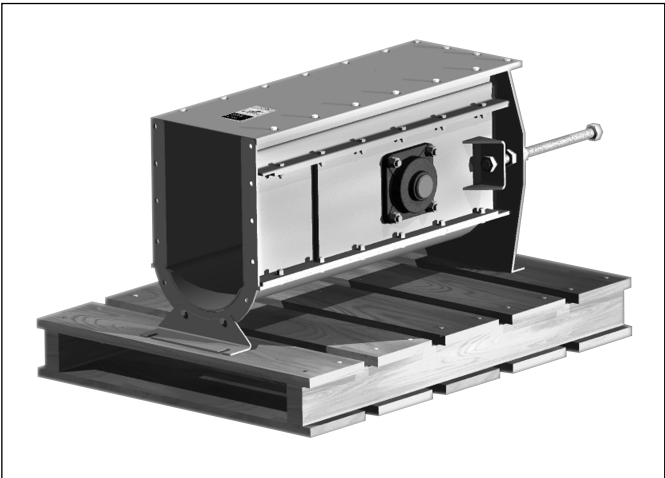

**Round Bottom Tail Take-up**

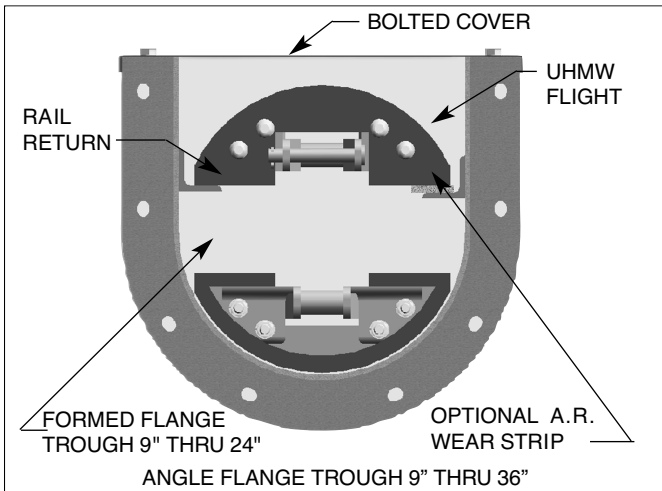

**Rail Return**

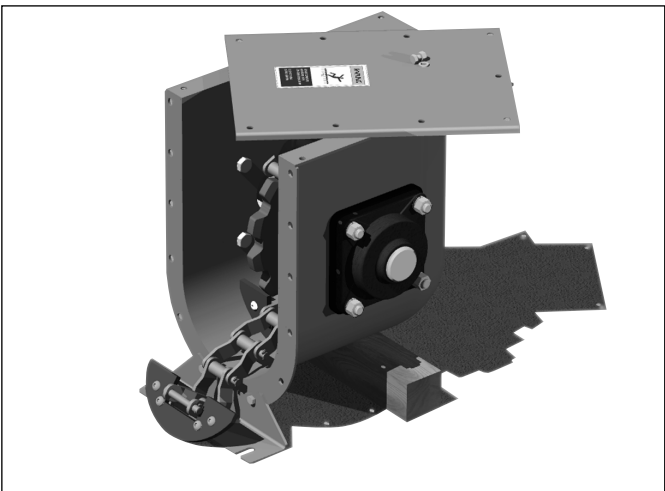

**Self-Cleaning Tail**

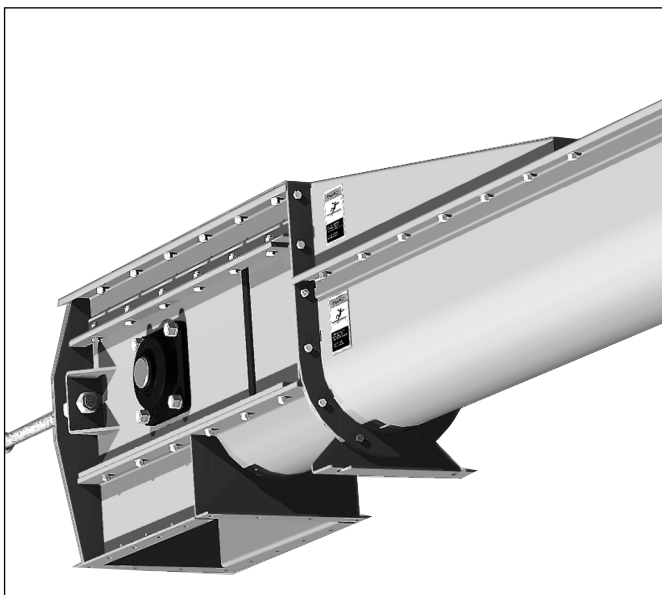

**Head Take-up**

### Standard Features

- Bolted Flanged Covers
- Welded Steel Chain
- Jig Welded Flight Attachment
- UHMW Flights
- Heavy Duty Form Flange Trough
- Heat Treated Sprockets
- Rail Return System
- Flow Through Inlets
- Heavy Duty Backing Plate

### Popular Options

- By-Pass Inlets
- Hip Roof Cover
- Self-Cleaning Tail Section
- Intermediate Discharge
- Bend Section
- Flight Saver Idler Return System
- Optional A.R. Wear Strip
- Split Sprockets

CONVEYORS



# Round Bottom Drag Conveyor

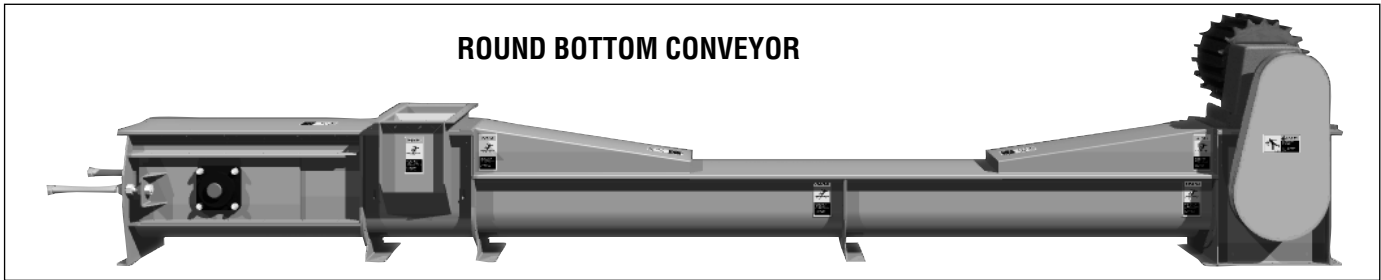

ROUND BOTTOM CONVEYOR

### Capacity FPM/RPM

Series	Size	100 FPM		125 FPM		150 FPM		175 FPM		200FPM	
		CFH	RPM	CFH	RPM	CFH	RPM	CFH	RPM	CFH	RPM
900	9"	2040	33	2600	41	3050	50	3500	58	4080	66
1200	12"	3475	33	4300	41	5200	50	6075	58	6950	66
1400	14"	4750	33	5900	40	7100	50	8300	58	9500	66
1600	16"	6050	32	7600	40	9150	48	10600	56	12100	64
1800	18"	8100	32	10150	40	12300	48	14300	56	16200	64
2000	20"	10500	23	13000	29	15650	35	18200	40	21000	46
2400	24"	14800	23	18150	29	22000	35	25750	40	29600	46

Note: Dimensions not certified for construction.

### NOTES:

1. Capacities are based on 100% loading with free-flowing grains at 48 pounds per cubic foot.
2. Selection of conveyors should be based upon material characteristics.
3. Capacities and speeds will vary for other types of materials and for materials conveyed at an incline.

Please consult *Martin* if you have any questions concerning your application.

### Material Thickness and Approximate Shipping Weights

Series	Adj. Tail	Weight <sup>1</sup>	Bypass	Weight	Fixed Head	Weight	Intermediate				Cover
							Standard Duty	Weight <sup>2</sup>	Specific Duty	Weight <sup>2</sup>	
1200	3/16"	394	3/16"	127	3/16"	210	12 ga.	285	3/16"	420	14 ga.
1400	3/16"	412	3/16"	140	3/16"	221	12 ga.	310	3/16"	460	14 ga.
1600	3/16"	475	3/16"	160	3/16"	257	12 ga.	365	3/16"	520	14 ga.
1800	3/16"	575	3/16"	238	3/16"	281	10 ga.	507	3/16"	640	12 ga.
2000	1/4"	856	3/16"	295	3/16"	486	10 ga.	578	3/16"	705	12 ga.
2400	1/4"	899	3/16"	370	3/16"	665	10 ga.	742	3/16"	870	12 ga.

### NOTES:

1. Tail and head weights shown include bearings, shafts, and standard sprockets.
2. Intermediate weights include return rails and bolted covers.

6", 30", and 36" Drag conveyors are also available upon request. Please contact *Martin* for quote.

*Martin* has designed its Round Bottom with the user in mind. We have incorporated larger heat-treated sprockets into our designs to reduce noise, vibration and chordal action while increasing chain and sprocket life. Our goal is to reduce maintenance and operating costs for the user.

either a rail return or optional Flight Saver Idler return system. Both systems assure long life and quiet operation.

All drag flights are a (food safe) white UHMW polyethylene material attached to welded steel chain, with exception of the 6" drag conveyor which uses combination chain.

We offer the *Martin* Round Bottom Drag with

# Round Bottom Drag Conveyor

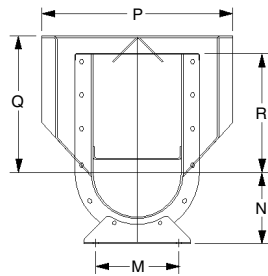
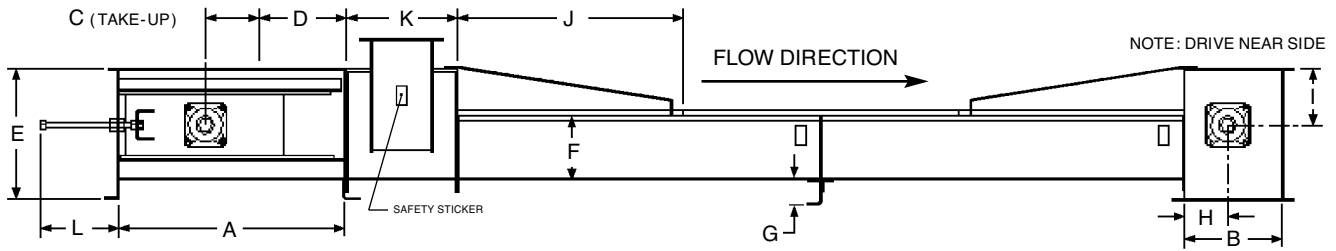

**BY-PASS INLET**

SERIES	A	B	C	D	E	F	G	H	I	J	K	L	M	N	P	Q	R
900	38	18	9	14¼	21⅝	11⅞	3⅝	9	9⅞	36	18	13	9⅞	8⅞	20⅞	15⅞	13⅝
1200	38	20	9	14¼	23¾	14¼	2⅝	10	9⅞	36	21	13	12¼	9½	24⅞	15⅞	13⅝
1400	38	20	9	14¼	24	16¾	3⅝	10	10⅞	36	23	13	13½	10¾	24⅞	15⅞	13⅝
1600	38	24	9	14¼	26	19⅞	3⅝	12	11⅞	36	25	13	14⅞	11⅞	28⅞	16¼	14¼
1800	38	24	9	14¼	27½	21⅞	3⅝	22	11⅞	24	27	13	16	13¼	29	16	14¼
2000	41	29	12	16	33¼	24	4¼	14½	14⅞	24	29	16	19¼	14⅞	34	20½	18½
2400	41	34	12	16	36½	29	5⅞	17	15⅞	24	33	16	20	18⅞	39	20⅞	18⅞

CONVEYORS

SERIES	A	B	C	D	E	F	G	H	J
900	10	⅞	1	4	—	4	4	18	2
1200	13	⅞	1¼	5⅞	—	5¼	5¼	20	2
1400	15	⅞	1¼	3½	3½	3½	5¼	20	2
1600	17	⅞	1¼	3¾	4	4	3⅞	24	2
1800	19	⅞	1¼	4⅞	4⅞	4⅞	3⅞	24	2
2000	21	⅞	1½	4⅞	4¼	4¼	4	29	4
2400	25	⅞	1½	5⅞	5⅞	5½	6½	34	4

NOTE: Dimensions not certified for construction.

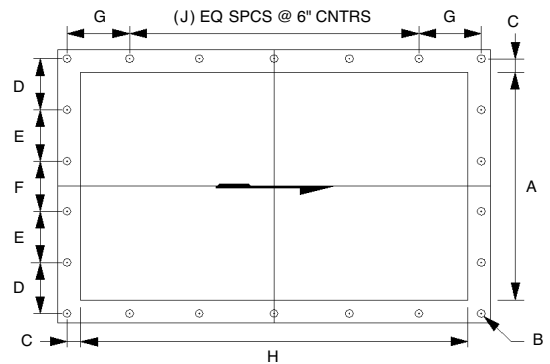

**BY-PASS INLET, HEAD & INTERMEDIATE DISCHARGE**

## WARNING AND SAFETY REMINDER

LOCK OUT POWER before removing covers, guards or before servicing. Exposed moving parts can cause severe injury.

Note: Dimensions not certified for construction.

*Martin*

## Flat Bottom Drag Conveyor

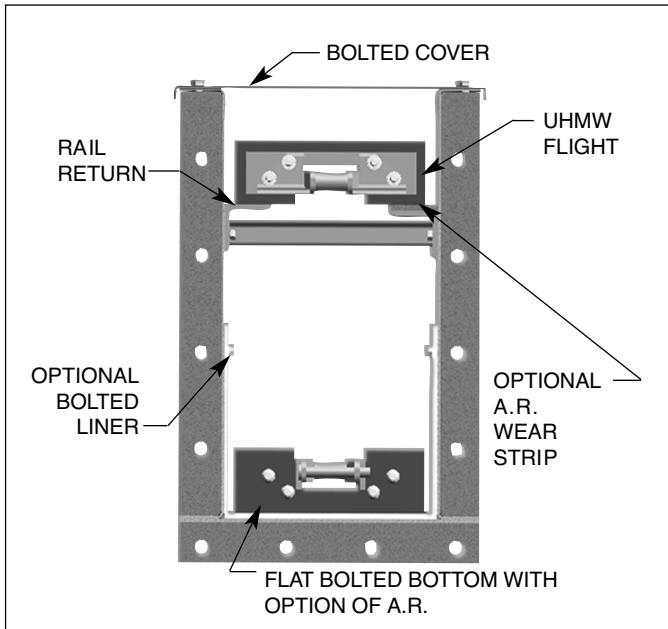

**Rail Return**

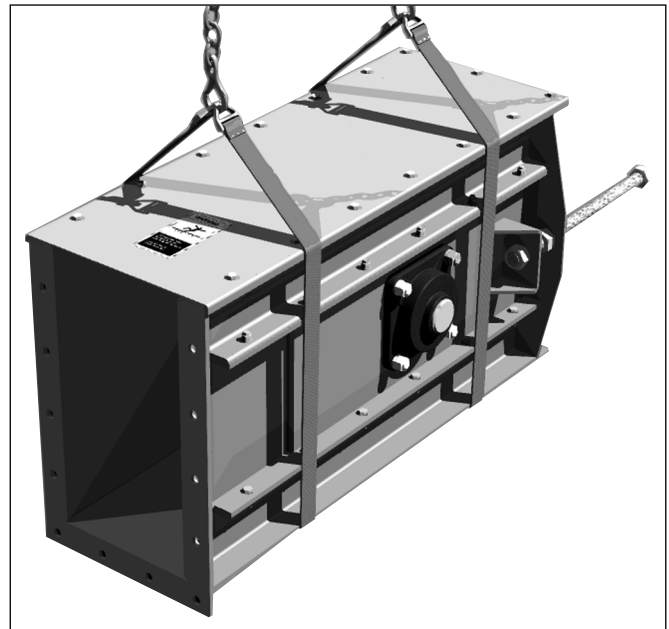

**Flat Bottom Tail Take-Up**

### Standard Features

- Bolted Replaceable Bottom
- Bolted Flanged Covers
- Jig Welded Flight Attachment
- UHMW Flights
- Heat Treated Sprockets
- Rail Return System
- Flow Through Inlets
- Heavy Duty Backing Plate

### Popular Options

- Intermediate Discharge
- Liners of Various Materials
- A.R. Steel Bottom Plate
- Controlled Feed Inlets
- Split Sprockets

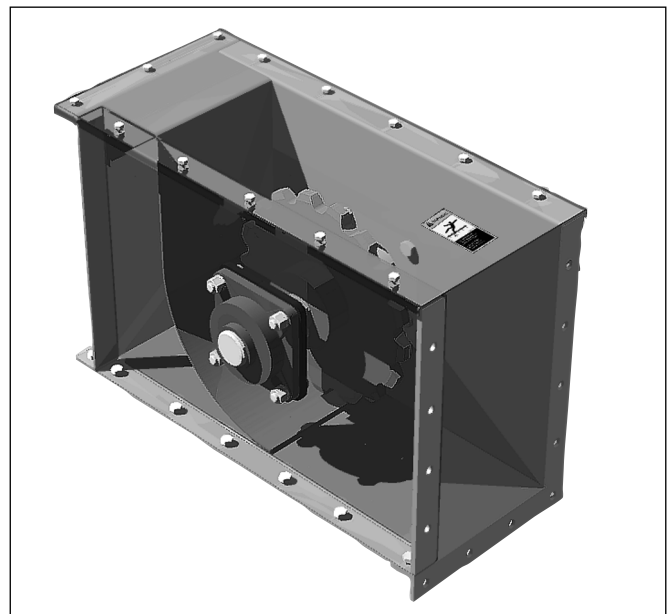

**Self-Cleaning Tail**

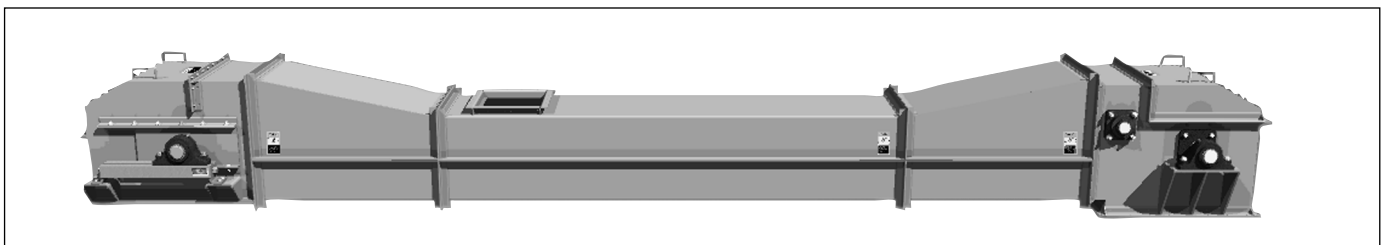

**Super Duty Conveyor**

\*Conveyors shown without cover for illustration purposes only. Please follow manufacturing safety guidelines when operating conveyors.

VISIT OUR WEBSITE AT [WWW.CLARKTR.COM](http://WWW.CLARKTR.COM)

H-149

CONVEYORS



# Flat Bottom Drag Conveyor

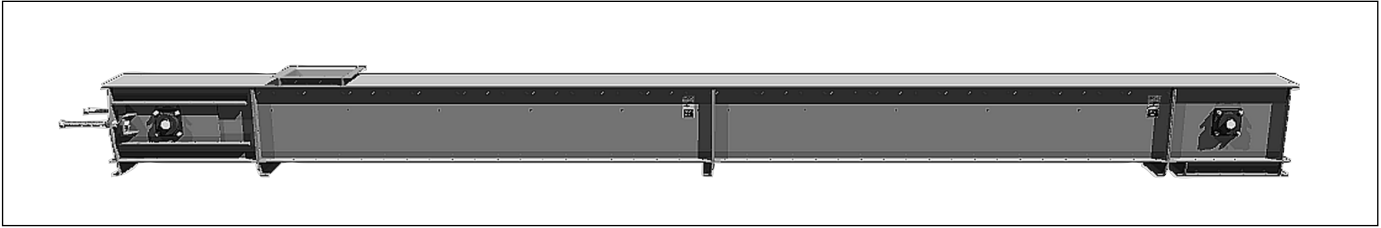

Flat Bottom Conveyor

SERIES	1 FPM			100 FPM			125 FPM			150 FPM			175 FPM			200 FPM		
	CFH	CFH	RPM	CFH	RPM	CFH	RPM	CFH	RPM	CFH	RPM	CFH	RPM	CFH	RPM	CFH	RPM	
1809	28.13	2,813	37	3,516	46	4,220	55	4,923	65	5,626	74							
2409	54.38	5,438	27	6,798	34	8,157	40	9,517	47	10,876	54							
2412	68.25	6,825	27	8,531	34	10,238	40	11,944	47	13,650	54							
2414	78.75	7,875	27	9,844	34	11,813	40	13,781	47	15,750	54							
2416	89.25	8,925	27	11,156	34	13,388	40	15,619	47	17,850	54							
2418	96.19	9,619	27	12,024	34	14,429	40	16,833	47	19,238	54							
3016	111.56	11,156	23	13,945	29	16,734	34	19,523	40	22,312	46							
3018	121.13	12,113	23	15,141	29	18,170	34	21,198	40	24,226	46							
3020	133.88	13,388	23	16,735	29	20,082	34	23,429	40	26,776	46							
3024	159.38	15,938	23	19,923	29	23,907	34	27,892	40	31,876	46							

**NOTES:**

1. Capacities are based on 90% loading with free-flowing grains at 48 pounds per cubic foot.
2. Selection of conveyors should be based upon material characteristics.
3. Capacities and speeds will vary for other types of materials and for materials conveyed at an incline.
4. Capacities at 90% bed depth.

Please consult *Martin* if you have any questions concerning your application.

MATERIAL THICKNESS & APPROXIMATE SHIPPING WEIGHTS							
SERIES	ADJ. TAIL	WGT.	HEAD	WGT.	INTERMEDIATE		COVER
					STD. DUTY	WGT.	
1809	10 GA.	333	10 GA.	206	10 GA.	403	14 GA.
2409	10 GA.	432	10 GA.	277	10 GA.	460	14 GA.
2412	10 GA.	454	10 GA.	306	10 GA.	492	14 GA.
2414	10 GA.	467	10 GA.	315	10 GA.	514	14 GA.
2416	10 GA.	482	10 GA.	322	10 GA.	532	14 GA.
2418	10 GA.	497	10 GA.	335	10 GA.	544	12 GA.
3016	3/16	642	3/16	438	10 GA.	655	12 GA.
3018	3/16	655	3/16	452	10 GA.	679	12 GA.
3020	3/16	690	3/16	485	10 GA.	703	12 GA.
3024	3/16	749	3/16	613	10 GA.	745	12 GA.

**NOTES:**

1. Tail and head weights shown include bearings, shafts and standard sprockets.
2. Intermediate weights include return rails, and bolted covers.

**Warning And Safety Reminder**

**LOCK OUT POWER** before removing covers, guards or before servicing. Exposed moving parts can cause severe injury.

*Martin* offers a complete line of standard Flat Bottom Drags to handle capacities up to 31,876 CFH.

*Martin* Super Duty Flat Bottom drags have been successfully used in applications with conveyors reaching lengths of over 660 feet and large capacities.

The *Martin* Flat Bottom drag conveyor is constructed with heavy-duty formed channel sides,

with replaceable bolted bottoms and covers. The replaceable rail return system is offered with an optional rail liner when wear is a concern.

The *Martin* Flat Bottom drag conveyor is especially suited for handling free flowing grains. When heavier abrasive materials need to be conveyed, contact *Martin* about our Mill Duty Drag conveyor with Forged Chain.

Note: Dimensions not certified for construction.



# Flat Bottom Drag Conveyor

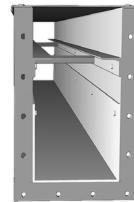
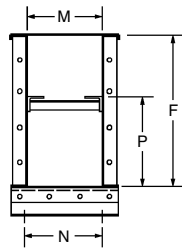
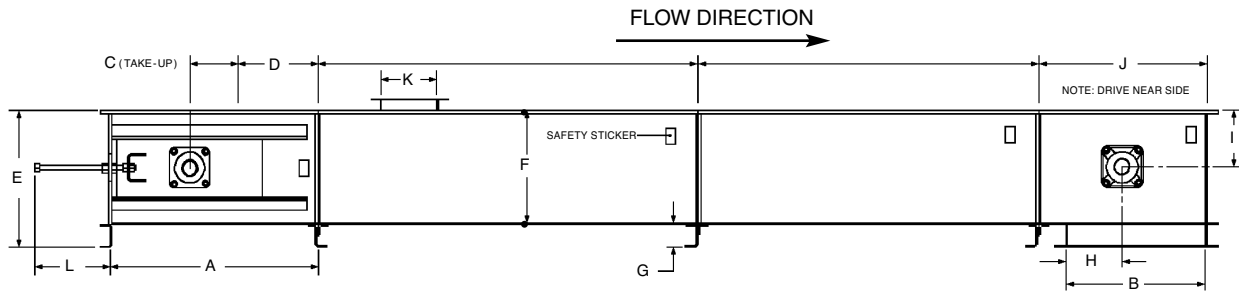

Flat Intermediate

SERIES	A	B	C	E	F	G	H	I	J	K	L	M	N	P
1809	37	25	9	18½	14¼	4	17¼	7¼	30	16	13	10	9¾	9
2409	37	25	9	24½	20¼	4	15	10¾	30	16	13	10	9¾	16
2412	37	30	9	24½	20¼	4	17½	10¾	35	18	13	13	12¼	16
2414	37	30	9	24½	20¼	4	17½	10¾	35	20	13	15	13½	16
2416	37	30	9	24½	20¼	4	17½	10¾	35	22	13	17	14¾	16
2418	37	30	9	24½	20¼	4	17½	10¾	35	25	13	19	16	16
3016	37	36	9	29½	25¼	4	20½	12¾	41	22	13	17	14¾	19½
3018	37	36	9	29½	25¼	4	20½	12¾	41	25	13	19	16	19½
3020	37	36	9	29½	25¼	4	20½	12¾	41	27	13	21	19¼	19½
3024	37	36	9	29½	25¼	4	20½	12¾	41	31	13	25	20	19½

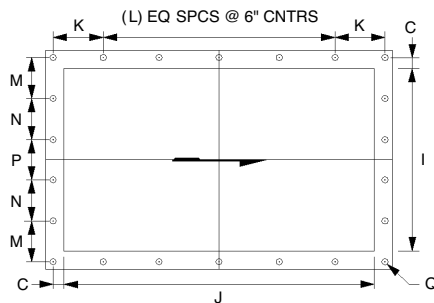

Head & Intermediate Discharge

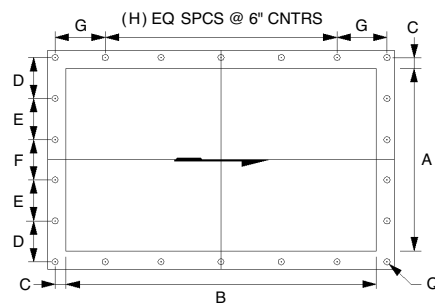

Standard Inlet

SERIES	A	B	C	D	E	F	G	H	I	J	K	L	M	N	P	Q
1809	7	16	1	4½	***	***	3	2	10	25	3½	3	4	***	4	⅞
2409	7	16	1	4½	***	***	3	2	10	25	3½	3	4	***	4	⅞
2412	10	18	1¼	4	***	***	4¼	2	13	30	4¼	4	5½	***	5¼	⅞
2414	12	20	1¼	4½	***	***	5¼	2	15	30	4¼	4	3½	3½	3½	⅞
2416	14	22	1¼	3¾	3¾	3¾	3¾	3	17	30	4¼	4	3¾	4	4	⅞
2418	15	25	1½	3½	3½	3½	5	3	19	30	4¼	4	4⅞	4¾	4⅞	⅞
3016	14	22	1½	3¾	3¾	3¾	3¾	3	17	36	4½	5	3¾	4	4	⅞
3018	15	25	1½	3½	3½	3½	5	3	19	36	4½	5	4⅞	4¾	4⅞	⅞
3020	17	27	1½	4	4	4	6	3	21	36	4½	5	4¾	4¾	4¾	⅞
3024	21	31	1½	3¾	3¾	3¾	5	4	25	36	4½	5	5¾	5½	5½	⅞

Note: Dimensions not certified for construction.

# Flat Bottom Drag Conveyor



**Mill Duty Conveyor**

### Standard Features

- Forged Chain and Steel Flights
- A.R. Steel Return Tray or Rail Return System
- Spring Loaded Take-up
- Split Sprockets

### Popular Options

- A.R. Steel Side Liners
- By-pass Inlet
- Self-cleaning Tail

Capacities and Speeds					
SERIES	FPM	25 FPM		50 FPM	
	CFH	CFH	RPM	CFH	RPM
1200 MD	58	1400	8	2800	16
1600 MD	96	2400	7.5	4800	15
2000 MD	130	3250	5	6500	10
2400 MD	192	4800	5	9600	10

The *Martin* Mill Duty Drag is designed for handling heavy and abrasive materials, such as limestone, aggregate, and sand.

Please consult *Martin* if you have any questions concerning your application.

### Warning And Safety Reminder

**LOCK OUT POWER** before removing covers, guards or before servicing. Exposed moving parts can cause severe injury.

CONVEYORS

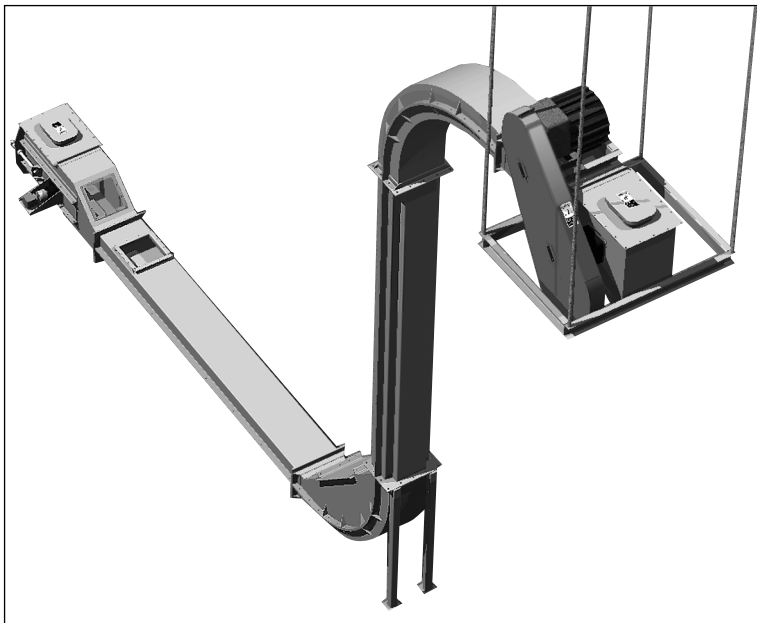

**Special Application Drag**



*Martin*-Built Take-up





# L-Path Drag Conveyor

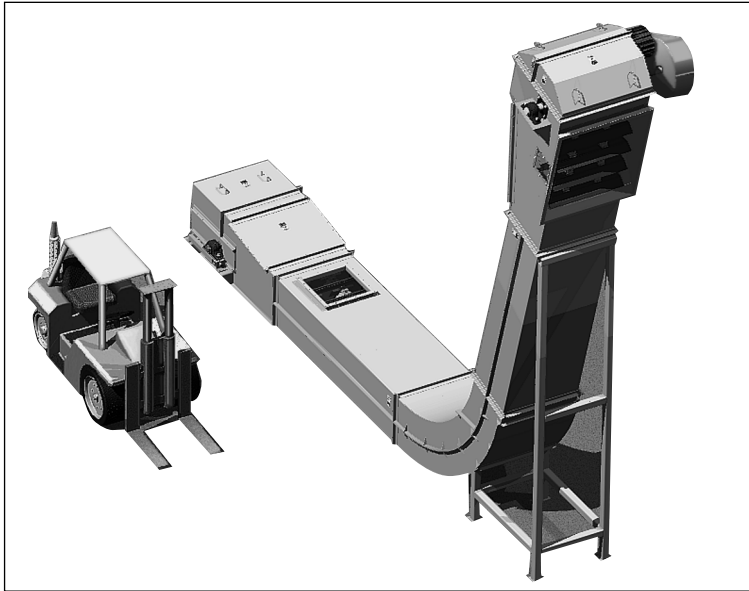

**L-Path Conveyor**

Series	1FPM	50 FPM		75 FPM		100 FPM	
	CFH	CFH	RPM	CFH	RPM	CFH	RPM
57	12	600	17	900	26	1200	35
610	20	1000	11	1500	16-1/2	2000	22
913	35	1750	8	2625	12	3500	16
1020	58	2900	11	4350	16-1/2	5800	22
1224	87	4350	11	6525	16-1/2	8700	22
1236	129	6450	10	9675	15	12900	20
1342	150	7500	10	11250	15	15000	20

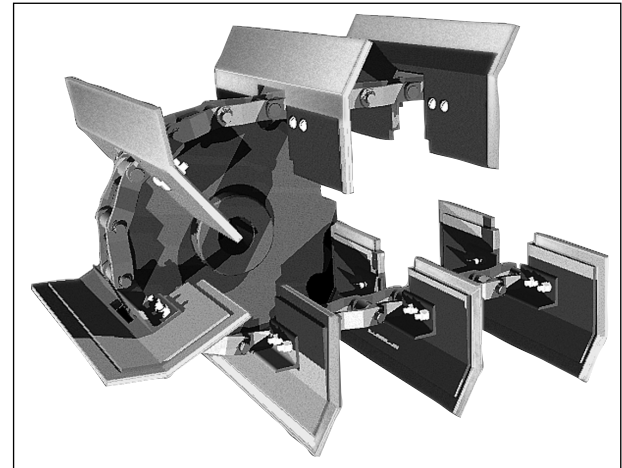

**Single Chain Configuration**



**S-Path Conveyor**

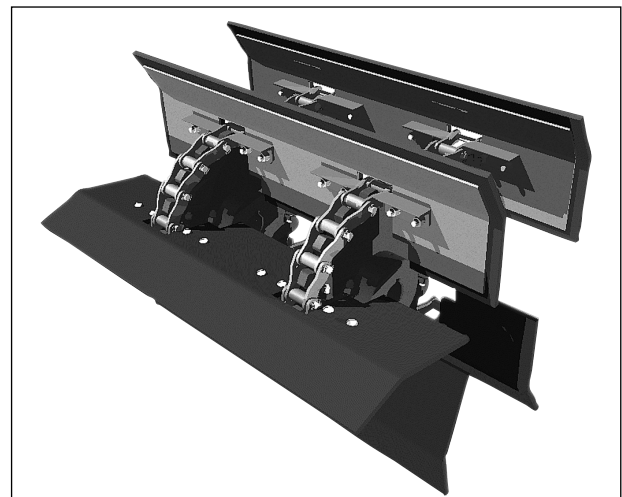

**Double Chain Configuration**

**NOTES:**

- Capacities are based on the handling of non-abrasive materials (as listed).
  - Cotton Seed Hulls • Cotton Seed Meal • Delinted Cotton Seed
  - Ground Feed • Whole Soybeans • Hot Soybean Meal
  - Whole Corn • Whole Rice
- CAUTION** should be observed when handling fine granular materials (as listed).
  - Wheat Flour • Sugar • Powdered Lime • Starch
  - Carbon Black • Soda Ash

**CHAIN FEATURES**

- Welded Steel or Forged Chain
- UHMW Flights
- Jig Welded Attachments
- Heavy Duty Backing Plates

Please consult *Martin* if you have any questions concerning your application.

CONVEYORS

# L-Path Drag Conveyor



## L-Path Conveyor

Series	610	913	1020	1224	1236	1342
A	68	89	96	96	96	96
B	29	37	35	38-5/8	38-5/8	38-5/8
C	12	12	12	12	12	12
D	2	2	2	2	2	2
E	14-1/2	20	22-1/4	28-1/4	28-1/4	28-1/4
F	3	3	6	6	6	6
G	96	96	96	120	120	120
H	82	108	108	116	116	116
I	36	42	54	60	60	60
J	32	38	40	44	44	44
K	18-3/4	22-1/2	28-1/2	32-1/2	44-1/2	50-1/2
L	18-3/4	22-1/2	28-1/2	32-1/2	44-1/2	50-1/2
M	11	14	21	25	37	43
N	4-1/8	4-1/8	4-1/8	4-1/8	4-1/8	4-1/8
P	21-1/2	25	25	29	29	29
Q	36-1/8	42-1/8	44-1/8	48-1/8	48-1/8	48-1/8

Consult factory for information on 57 Series and other sizes.

Note: Dimensions not certified for construction.

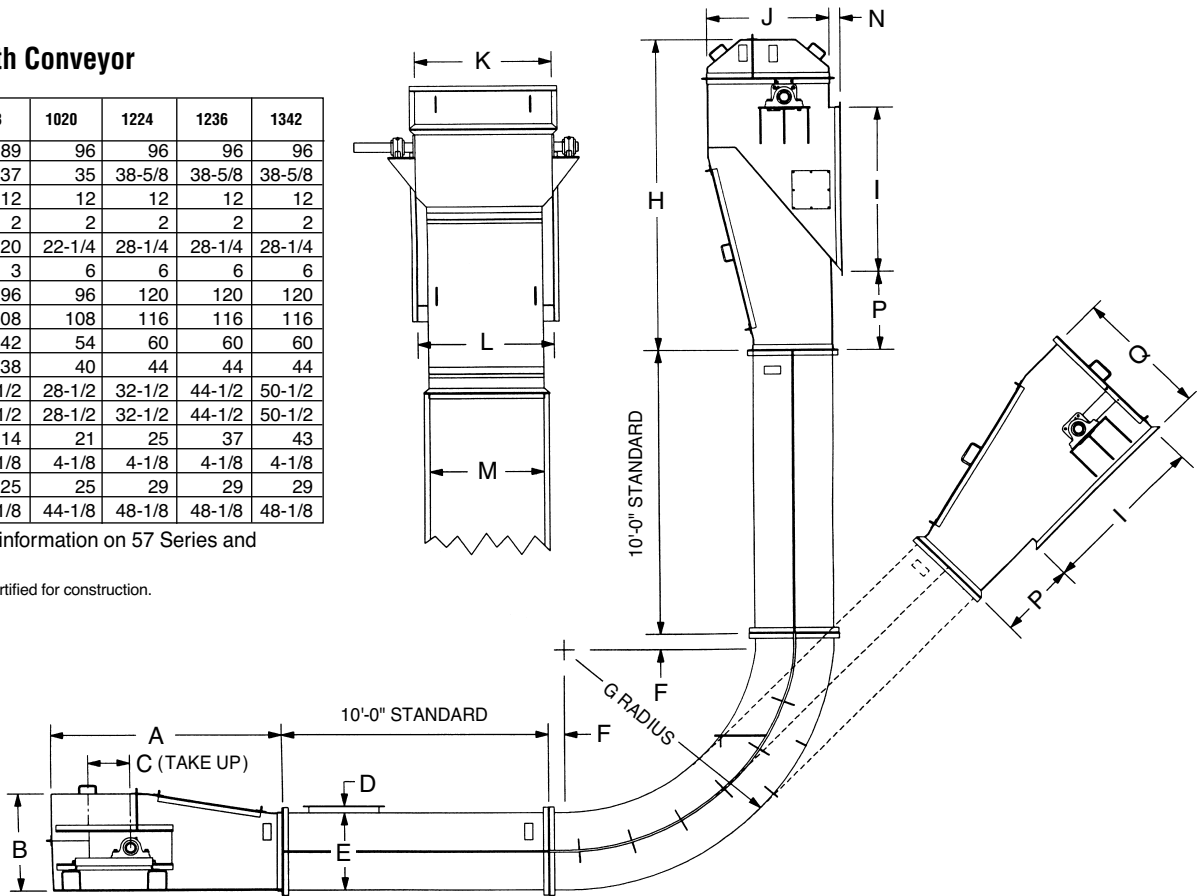

### Standard Inlet

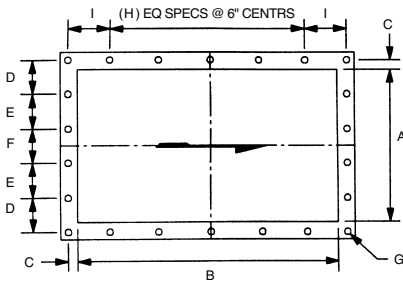

### Head Discharge 45°-90°

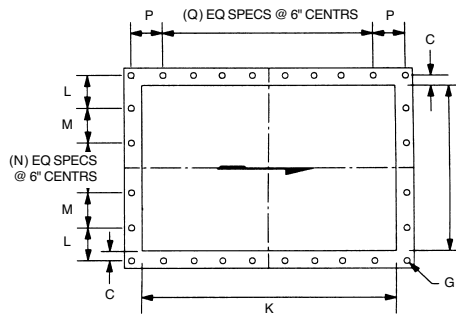

### Head Discharge 0°-45°

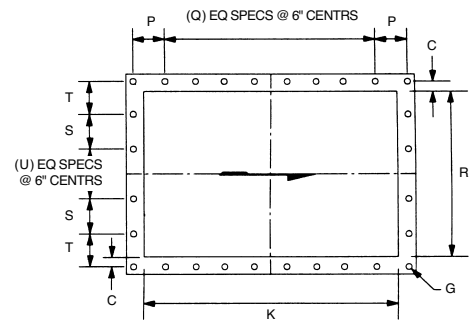

SERIES	A	B	C	D	E	F	G	H	I	J	K	L	M	N	P	Q	R	S	T	U
610	7	16	1	4½	***	***	7/16	2	3	18¾	36	4¾	***	2	4	5	11	***	3½	3½
913	10	18	1¼	4	***	4½	7/16	2	4¼	22½	42	4¾	4¼	1	4¼	6	14	4¼	3½	1
1020	17	27	1½	4	4	4	9/16	3	6	29	54	4	***	4	4½	8	21	4½	4½	1
1224	21	31	1½	4¾	4¾	5	9/16	4	5	33	60	***	***	6	4½	9	25	***	5	3
1236	33	43	1½	4½	6	6	9/16	6	5	45	60	***	***	8	4½	9	37	***	5	5
1342	38	48	1½	5½	6	6	9/16	7	4½	51	60	4½	4½	6	4½	9	43	4	4	5

Note: Dimensions not certified for construction.

*Martin*

# Vertical Screw Elevator

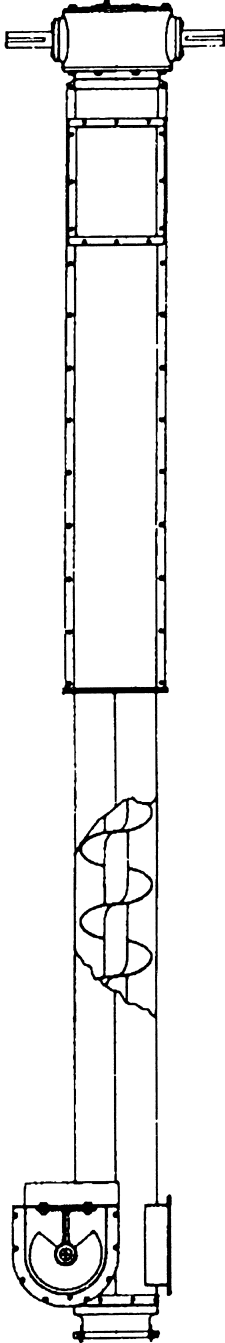

**Standard Screw  
Elevator**

## SECTION VIII VERTICAL SCREW ELEVATOR SECTION VIII

Warning and Safety Reminder .....	H-156
Introduction .....	H-157
Screw Elevator Types .....	H-158
Standard Components .....	H-159
Standard Screw Elevator Speed and Capacity .....	H-160
Type B Dimensions .....	H-161
Super Screw Elevator Speed and Capacity .....	H-162
Super Screw Drive Unit .....	H-163
Super Screw Elevator Dimensions .....	H-164

# Warning & Safety Reminder



## WARNING AND SAFETY REMINDERS FOR SCREW, DRAG, AND BUCKET ELEVATOR CONVEYORS

APPROVED FOR DISTRIBUTION BY THE SCREW CONVEYOR SECTION OF THE CONVEYOR EQUIPMENT MANUFACTURERS ASSOCIATION (CEMA)

It is the responsibility of the contractor, installer, owner and user to install, maintain and operate the conveyor, components and, conveyor assemblies in such a manner as to comply with the Williams-Steiger Occupational Safety and Health Act and with all state and local laws and ordinances and the American National Standards Institute (ANSI) B20.1 Safety Code.

In order to avoid an unsafe or hazardous condition, the assemblies or parts must be installed and operated in accordance with the following minimum provisions.

1. Conveyors shall not be operated unless all covers and/or guards for the conveyor and drive unit are in place. If the conveyor is to be opened for inspection cleaning, maintenance or observation, the electric power to the motor driving the conveyor must be LOCKED OUT in such a manner that the conveyor cannot be restarted by anyone; however remote from the area, until conveyor cover or guards and drive guards have been properly replaced.
2. If the conveyor must have an open housing as a condition of its use and application, the entire conveyor is then to be guarded by a railing or fence in accordance with ANSI standard B20.1. (Request current edition and addenda)
3. Feed openings for shovel, front loaders or other manual or mechanical equipment shall be constructed in such a way that the conveyor opening is covered by a grating. If the nature of the material is such that a grating cannot be used, then the exposed section of the conveyor is to be guarded by a railing or fence and there shall be a warning sign posted.
4. Do not attempt any maintenance or repairs of the conveyor until power has been LOCKED OUT.
5. Always operate conveyor in accordance with these instructions and those contained

on the caution labels affixed to the equipment.

6. Do not place hands, feet, or any part of your body, in the conveyor.
7. Never walk on conveyor covers, grating or guards.
8. Do not use conveyor for any purpose other than that for which it was intended.
9. Do not poke or prod material into the conveyor with a bar or stick inserted through the openings.
10. Keep area around conveyor drive and control station free of debris and obstacles.
11. Eliminate all sources of stored energy (materials or devices that could cause conveyor components to move without power applied) before opening the conveyor
12. Do not attempt to clear a jammed conveyor until power has been LOCKED OUT.
13. Do not attempt field modification of conveyor or components.
14. Conveyors are not normally manufactured or designed to handle materials that are hazardous to personnel. These materials which are hazardous include those that are explosive, flammable, toxic or otherwise dangerous to personnel. Conveyors may be designed to handle these materials. Conveyors are not manufactured or designed to comply with local, state or federal codes for unfired pressure vessels. If hazardous materials are to be conveyed or if the conveyor is to be subjected to internal or external pressure, manufacturer should be consulted prior to any modifications.

CEMA insists that disconnecting and locking out the power to the motor driving the unit provides the only real protection against injury. Secondary safety devices are available; however, the decision as to their need and the type required must be made by the owner-assembler

as we have no information regarding plant wiring, plant environment, the interlocking of the screw conveyor with other equipment, extent of plant automation, etc. Other devices should not be used as a substitute for locking out the power prior to removing guards or covers. We caution that use of the secondary devices may cause employees to develop a false sense of security and fail to lock out power before removing covers or guards. This could result in a serious injury should the secondary device fail or malfunction.

There are many kinds of electrical devices for interlocking of conveyors and conveyor systems such that if one conveyor in a system or process is stopped other equipment feeding it, or following it can also be automatically stopped.

Electrical controls, machinery guards, railings, walkways, arrangement of installation, training of personnel, etc., are necessary ingredients for a safe working place. It is the responsibility of the contractor, installer, owner and user to supplement the materials and services furnished with these necessary items to make the conveyor installation comply with the law and accepted standards.

Conveyor inlet and discharge openings are designed to connect to other equipment or machinery so that the flow of material into and out of the conveyor is completely enclosed.

One or more warning labels should be visible on conveyor housings, conveyor covers and elevator housings. If the labels attached to the equipment become illegible, please order replacement warning labels from the OEM or CEMA.

The Conveyor Equipment Manufacturers Association (CEMA) has produced an audio-visual presentation entitled "Safe Operation of Screw Conveyors, Drag Conveyors, and Bucket Elevators." CEMA encourages acquisition and use of this source of safety information to supplement your safety program.

CONVEYORS



### PROMINENTLY DISPLAY THESE SAFETY LABELS ON INSTALLED EQUIPMENT

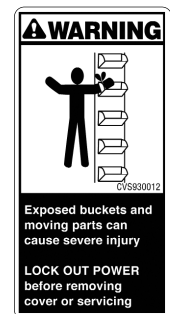
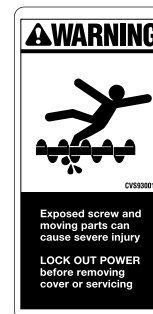
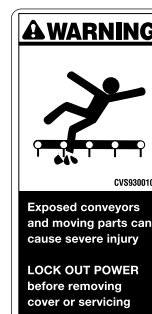

NOTICE: This document is provided by CEMA as a service to the industry in the interest of promoting safety. It is advisory only and it is not a substitute for a thorough safety program. Users should consult with qualified engineers and other safety professionals. CEMA makes no representations or warranties, either expressed or implied, and the users of this document assume full responsibility for the safe design and operation of equipment.





# Screw Elevator

## Martin Screw Elevators

For over fifty years, *Martin* Standard Screw Elevators have been successfully elevating a wide range of materials. In 1956, we added the heavier duty Superscrew Elevator, giving our customers the ability to elevate larger capacities to greater heights.

The *Martin* Screw Elevator is ideally suited to elevate a wide range of bulk materials in a relatively small space. If a material can be classified as very free flowing or free flowing, it can probably be elevated in a Screw Elevator.

We offer both our Standard and Superscrew Elevators with several different drive arrangements to meet our customers' individual requirements. *Martin* has an experienced staff in over twenty locations throughout the U.S.A. and Canada that can help you design the right screw elevator for your application. We have the capability of manufacturing our screw elevators in six locations in the U.S.A.

Contact your nearest *Martin* facility with your application information and we will design the right elevator for your needs.

### Partial Material List

- |                |                     |
|----------------|---------------------|
| Alfalfa Meal   | Mixed Feeds         |
| Barley, Malted | Mustard Seed        |
| Bone Meal      | Oats                |
| Cement         | Paper Pulp          |
| Coffee         | Peanuts             |
| Corn Meal      | Resin               |
| Cotton Seed    | Rubber, Ground      |
| Cryolite       | Salt                |
| Flours         | Sawdust             |
| Grains         | Screened Wood Chips |
| Hops           | Shellac, Powder     |
| Ice            | Soda Ash            |
| Kaolin Clay    | Soybean Meal        |
| Lead Oxide     | Sugar               |
| Lime           | Sunflower Seeds     |
| Malt           | Tobacco             |
| Mica           | Wheat               |
| Milk, Dried    | Wood Flour          |

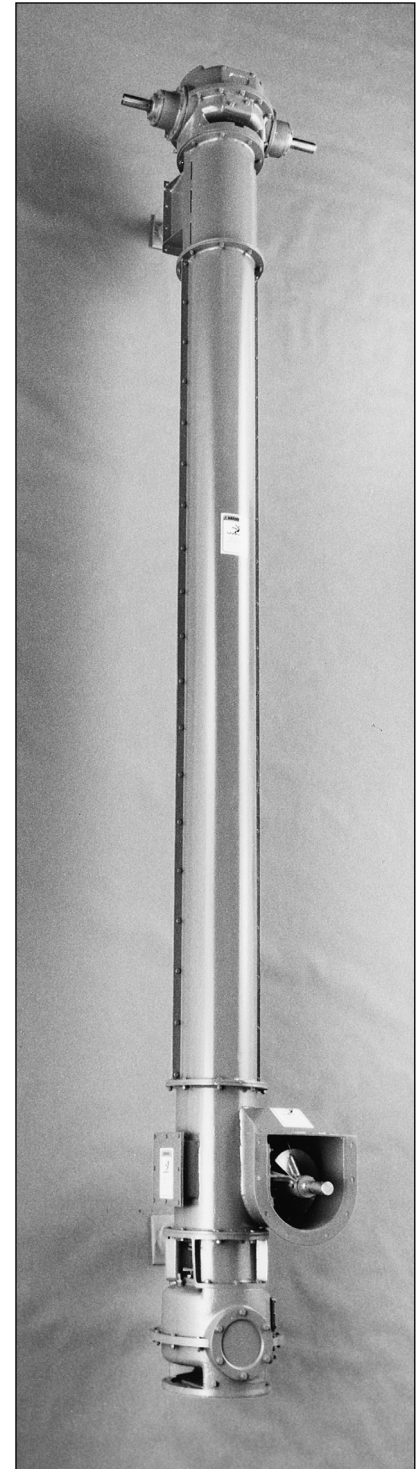

Type 4  
Superscrew Elevator

CONVEYORS

# Screw Elevator



## Martin Screw Elevators

To help better meet the needs of our customers, we offer both the *Martin* Standard and Superscrew Elevators in sixteen different types. The different types allow us to vary the drive location, discharge location and feed arrangement. We are also able to drive the feeder or take-away conveyor by the screw elevator drive.

The *Martin* Screw Elevators are easy to install because they are factory assembled, match-marked and disassembled prior to shipment. All *Martin* Screw Elevators are of a sturdy self-supporting design and only need lateral support when installed.

The drives for the *Martin* Standard and Superscrew Elevators are manufactured by *Martin* and are specifically designed for use with our screw elevators. We can also offer a Screw Conveyor Drive arrangement for lighter duty applications.

### Standard Screw Elevator Types

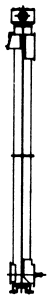

Type B  
Straight Inlet  
Top Drive,  
Pedestal Base

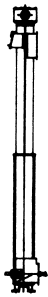

Type BO  
Offset Inlet  
Top Drive,  
Pedestal Base

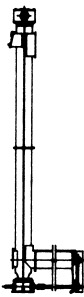

Type AF1  
Straight Inlet Top  
Drive, Bottom P.T.O.  
w/4'-0" Feeder  
And Drive

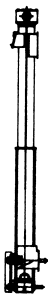

Type AF2  
Offset Inlet  
Top Drive,  
Bottom P.T.O.  
With Drive



Type EAF1  
Straight Inlet  
Bottom Drive,  
Thrust Head

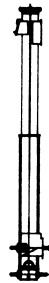

Type HAF2  
Offset Inlet  
Bottom Drive,  
Thrust Head  
With Drive

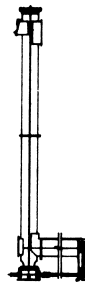

Type GAF1  
Straight Inlet  
Bottom Drive,  
Thrust Head w/4'-0"  
Feeder And Drive



Type IAF-2  
Offset Inlet  
Bottom Drive,  
Thrust Head

### SuperScrew Elevator Types

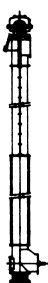

Type 1  
Straight Inlet  
Top Drive,  
Pedestal Base

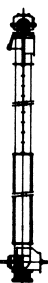

Type 2  
Offset Inlet  
Top Drive,  
Pedestal Base

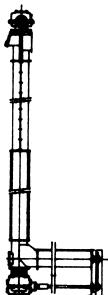

Type 3  
Straight Inlet Top  
Drive, Bottom P.T.O.  
w/4'-0" Feeder  
And Drive

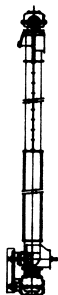

Type 4  
Offset Inlet  
Top Drive,  
Bottom P.T.O.  
With Drive

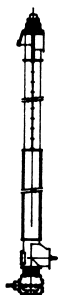

Type 5  
Straight Inlet  
Bottom Drive,  
Thrust Head

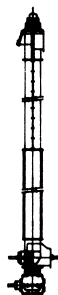

Type 6  
Offset Inlet  
Bottom Drive,  
Thrust Head

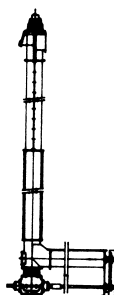

Type 7  
Straight Inlet  
Bottom Drive,  
Thrust Head w/4'-0"  
Feeder And Drive

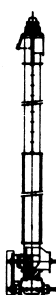

Type 8  
Offset Inlet  
Bottom Drive,  
Thrust Head  
With Drive

NOTE: All elevators are furnished less feeder and/or feeder drive unless otherwise specified.

CAUTION: Never operate without covers and guards. Always LOCKOUT/TAGOUT electrical power when working on equipment for inspection, cleaning, maintenance, or other purposes.



# Screw Elevator

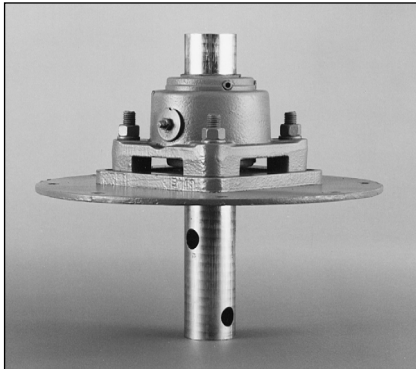

Standard Screw Thrust Unit



Stabilizer Bearing Used on Standard Screw Elevator

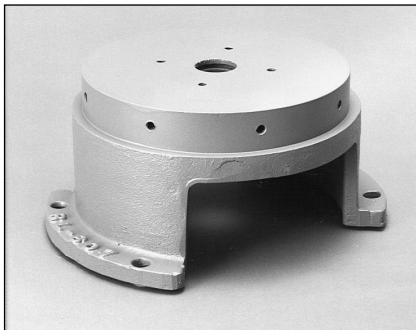

Standard Screw Pedestal Base



Standard Screw Thrust Head

All *Martin* Screw Elevators come with heavy duty helicoid or sectional screws which are checked for straightness and run-out to insure a smooth running elevator. When handling free flowing material, we add stabilizers as needed, as the height of the elevator increases. The stabilizer bearings are available in a wide range of bearing materials to meet our customers' requirements, including wood, hard iron, bronze, UHMW, and others.

Both the *Martin* Standard Screw and Superscrew Elevators are supplied with split intermediate housing to allow easier maintenance.

*Martin's* specially engineered inlet/bottom section assures a smooth transfer to conveyed material from the horizontal to vertical with a minimum of back-up and product degradation.

The bottom inspection panel is bolted to minimize any product leakage. It also has a shroud to assure that the conveyed material is moving smoothly through the area.

The drives for both the Standard Screw and the Superscrew Elevator are manufactured by *Martin* to guarantee their quality and availability.

## Clearance Between Screw and Housing

Size	Type of Housing	Clearance	Gauge of Housing			
			Standard Elevator		Superscrew Elevator	
			Intermediate	Top and Bottom Sections	Intermediate	Top and Bottom Sections
6	Standard Clearance	1/2	14	14	14	10
	Close Fitting Clearance	5/16	14	14	14	10
9	Standard Clearance	1/2	12	12	12	3/16
	Close Fitting Clearance	5/16	12	12	12	3/16
12	Standard Clearance	1/2	10	10	10	3/16
	Close Fitting Clearance	5/16	10	10	10	3/16
16	Standard Clearance	1/2			10	3/16
	Close Fitting Clearance	5/16			10	3/16

CONVEYORS



# Standard Screw Elevator



The *Martin* Standard Screw Elevator is designed to handle under normal conditions, capacities ranging from 360 CFH to 3600 CFH in 6" dia., 9" dia., and 12" dia. sizes. With complete information, *Martin* engineering staff can help you design the right Screw Elevator for your application.

## Martin Standard Screw Elevator Speed / Capacity

Size	Vertical Shaft Diameter	Ratio Top Drive	Ratio Bottom Drive	▲ Recommended Minimum and Maximum Speeds			RPM Horizontal Feeder Screw 45 Percent Loading	Capacity Cubic Foot per Hour
				Vertical Screw	Input Top Drive	Input Bottom Drive		
6	1½	2:1	1.4:1	200	400	280	165	360
				215	430	301	177	400
				275	550	385	226	500
9	1½	2:1	1.4:1	170	340	238	139	1100
				200	400	280	163	1300
				230	460	322	187	1500
12	2	2:1	2:1	155	310	310	147	2700
				165	330	330	156	3000
				200	400	400	189	3600

▲ For speeds in excess or less than shown, consult *Martin*.

The Standard Screw Elevator drive unit will function efficiently with the elevator erected at any angle of incline from horizontal to vertical. The input shaft can be driven in either direction, and the input shaft extension may be used to drive a horizontal feeder or discharge conveyor.

Both top and bottom drives are required when the elevator, feeder and discharge conveyor are all driven from one power source. A top drive and pedestal base are used when the elevator and discharge conveyor are driven from one source. A bottom drive and thrust unit are necessary if the elevator and feeder are driven from one power source. The drives are designed and constructed to withstand all radial and thrust loads and support the entire weight of a fully loaded elevator.

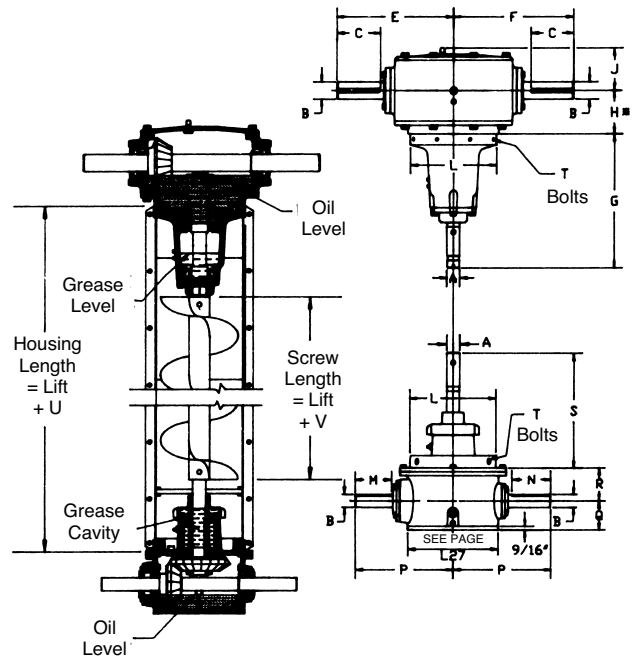

Dimensions in Inches

Size	Ratio		A	B		C	E	F	G	H	J	L	M	N	P	Q	R	S	T Bolts		U		V
	Top Drive	Bottom Drive		Top Drive	Bottom Drive														No. Rec'd	Size	B & BO	All Other Types	All Types
6"	2:1	1.4:1	1½	2	1½	5	13½	14	15¼	7%	4 <sup>15</sup> / <sub>16</sub>	7	4¼	4½	11 <sup>11</sup> / <sub>32</sub>	3%	3 <sup>3</sup> / <sub>16</sub>	13¼	4	¾-16 NC	16%	23%	6%
9	2:1	1.4:1	1½	2	1½	5	13½	14	15¼	5	4 <sup>15</sup> / <sub>16</sub>	10	4¼	4½	11 <sup>11</sup> / <sub>32</sub>	3%	3 <sup>3</sup> / <sub>16</sub>	13¼	8	¾-16 NC	21½	27%	8%
12	2:1	2:1	2	2	2	5	13½	14	15¼	4%	4 <sup>15</sup> / <sub>16</sub>	13	5	5 <sup>1</sup> / <sub>16</sub>	14 <sup>1</sup> / <sub>16</sub>	3%	4 <sup>1</sup> / <sub>16</sub>	13¼	8	½-13 NC	26	31%	12%

\*2½" lg. adapter for 6" head not illustrated

CAUTION: Never operate without covers and guards. Always LOCKOUT/TAGOUT electrical power when working on equipment for inspection, cleaning, maintenance, or other purposes.

Note: Dimensions not certified for construction.



# Standard Screw Elevator

**Type B**

**Type B0**

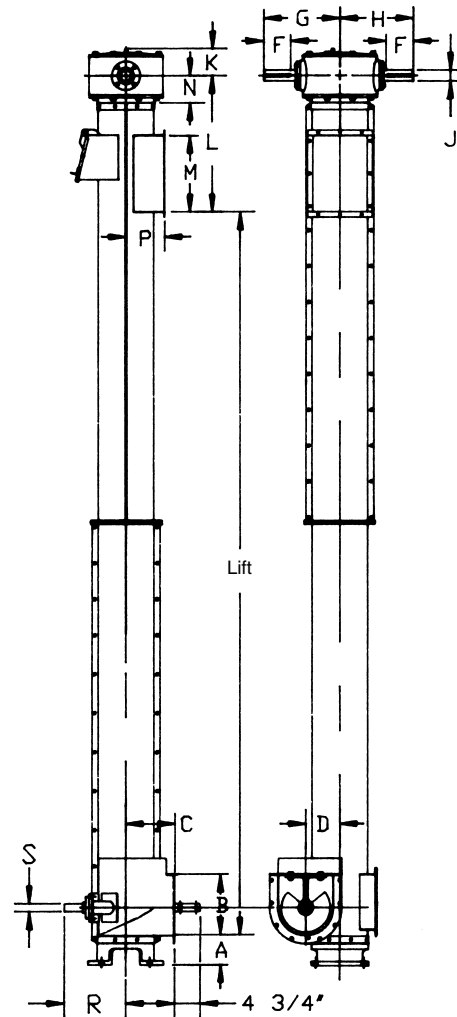
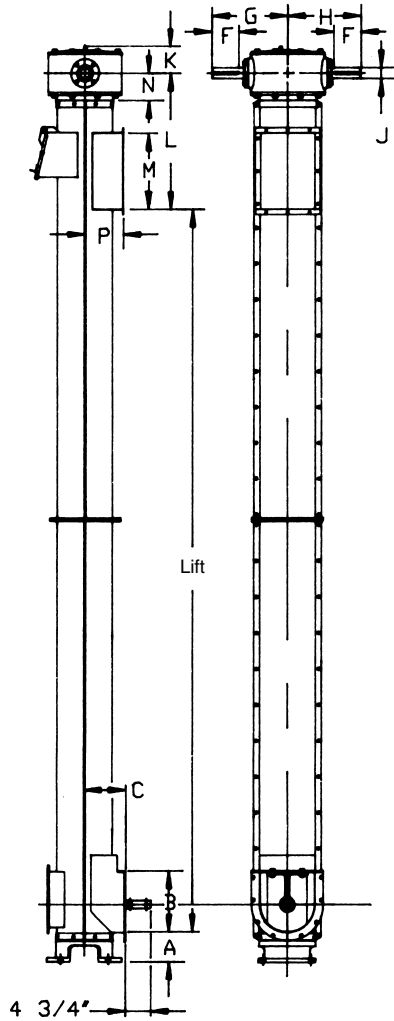

Screw elevator shown is offset to right for illustration purpose only. This elevator will normally be furnished offset to left, unless otherwise specified. See page H-158 for typical elevator arrangements.

**Type B0**

Size of Elevator	A	B	C	D	F	G	H	J	K	L	M	N	P	R	S
6	6	8	9	4¾	5	13½	14	2	4 <sup>15</sup> / <sub>16</sub>	23	12	7 <sup>7</sup> / <sub>8</sub>	5½	11 <sup>11</sup> / <sub>16</sub>	1½
9	5½	11 <sup>11</sup> / <sub>16</sub>	9	6¼	5	13½	14	2	4 <sup>15</sup> / <sub>16</sub>	25	14	5	7 <sup>7</sup> / <sub>8</sub>	11 <sup>11</sup> / <sub>16</sub>	1½
12	8	14¼	15	8	5	13½	14	2	4 <sup>15</sup> / <sub>16</sub>	29	18	4 <sup>7</sup> / <sub>8</sub>	8 <sup>3</sup> / <sub>4</sub>	14 <sup>14</sup> / <sub>16</sub>	2

**Type B**

Size of Elevator	A	B	C	F	G	H	J	K	L	M	N	P
6	6	8	9	5	13½	14	2	4 <sup>15</sup> / <sub>16</sub>	23	12	7 <sup>7</sup> / <sub>8</sub>	5½
9	5½	11 <sup>11</sup> / <sub>16</sub>	9	5	13½	14	2	4 <sup>15</sup> / <sub>16</sub>	25	14	5	7 <sup>7</sup> / <sub>8</sub>
12	8	14¼	15	5	13½	14	2	4 <sup>15</sup> / <sub>16</sub>	29	18	4 <sup>7</sup> / <sub>8</sub>	8 <sup>3</sup> / <sub>4</sub>

Dimensions in Inches

Note: Dimensions not certified for construction.

H-161

VISIT OUR WEBSITE AT [WWW.CLARKTR.COM](http://WWW.CLARKTR.COM)

# Super Screw Elevator



The *Martin* Superscrew Elevator is designed to handle capacities ranging from 360 CFH to 7000 CFH in 6" dia., 9" dia., 12" dia., and 16" dia. sizes.

## *Martin* SuperScrew Elevator Speed / Capacity

Size	Vertical Shaft Diameter	Ratio Top Drive	Ratio Bottom Drive	▲ Recommended Minimum and Maximum Speeds			RPM Horizontal Feeder Screw 45 Percent Loading	Capacity Cubic Foot per Hour
				Vertical Screw	Input Top Drive	Input Bottom Drive		
1	2	3	4	5	6	7	8	9
6	1½	2:1	2:1	200	400	400	165	360
				215	430	430	177	400
				275	550	550	226	500
				330	660	660	272	600
				Up to 425	Up to 850	Up to 850	★	★
9	2	2:1	2:1	170	340	340	139	1100
				200	400	400	163	1300
				230	460	460	187	1500
				240	480	480	196	1600
				Up to 425	Up to 850	Up to 850	★	★
12	2⅞	2:1	2:1	155	310	310	147	2800
				165	330	330	156	3000
				200	400	400	189	3600
				210	420	420	199	3800
	Up to 425	Up to 850	Up to 850	★	★			
	2⅞★ 3	2.06:1	2.06:1	155	319	319	151	2800
				165	340	340	161	3000
				200	412	412	195	3600
210				433	433	205	3800	
Up to 425	Up to 876	Up to 876	★	★				
16	3	2.06:1	2.06:1	138	284	284	132	6000
				150	309	309	144	6500
				161	332	332	155	7000
				Up to 425	Up to 876	Up to 876	★	★

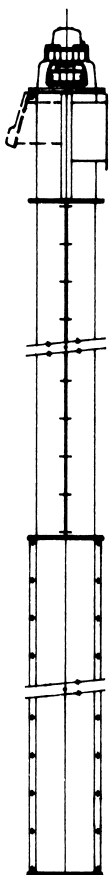

★ Consult *Martin*.  
▲ For speeds in excess or less than those shown, consult *Martin*.

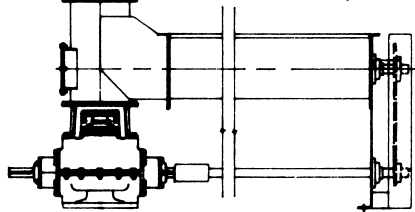

Type 7 Superscrew Elevator

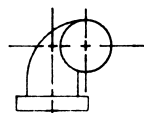

Elevator Offset to the Right of Inlet

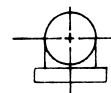

Straight Inlet

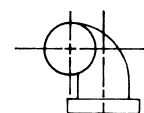

Elevator Offset to the Left of Inlet

CAUTION: Never operate without covers and guards. Always LOCKOUT/TAGOUT electrical power when working on equipment for inspection, cleaning, maintenance, or other purposes.

CONVEYORS



# Super Screw Elevator

## Super Screw Elevator D.S.D. (Dry Shaft Drive)

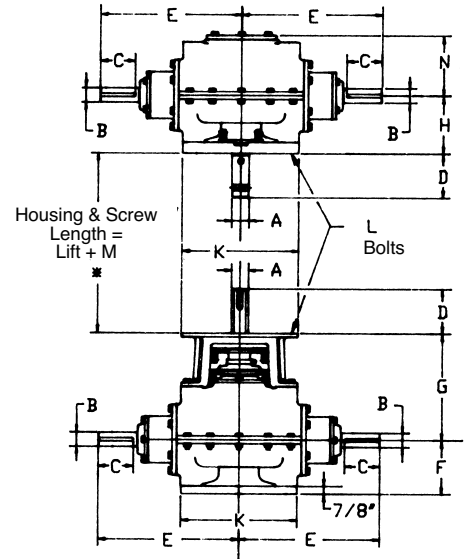
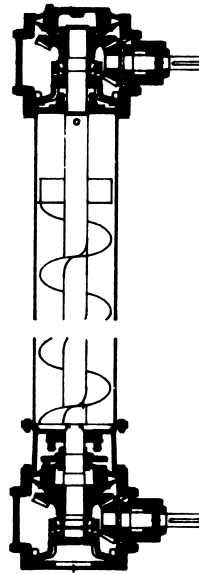
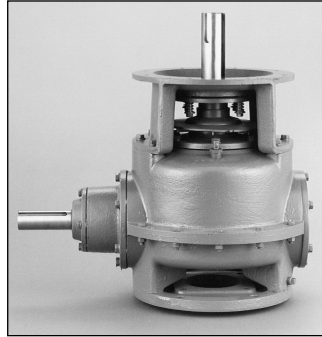
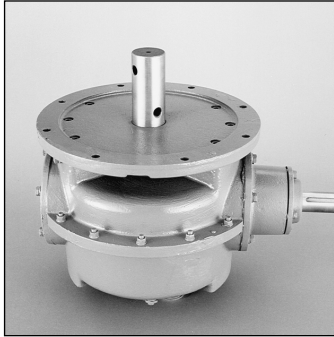

DSD (Dry Shaft Drive) is a completely new design and construction concept especially developed to enable the SuperScrew Elevator to broaden the application of screw elevators.

The DSD unit is designed to meet special conditions encountered in vertical installations and may be installed in the range of 70° to 90° incline. If a smaller angle of incline is required, special units may be furnished.

A patented lubrication system precisely “meters” the proper amount of lubricant to those points where needed with no danger of damaging seals.

DSD units may be furnished at both the top and the bottom of the elevator. The top drive incorporates special design features to assure that no lubricant may pass into the elevator to contaminate the material being elevated. In the bottom drive unit other special features prevent entrance of foreign material into lubricant.

DSD units may also be furnished at the top only with a pedestal base or at the bottom only with a thrust head.

The compactness of the DSD requires a minimum of head room providing maximum lift with minimum overall elevator height.

DSD units are sturdily constructed to withstand all radial and thrust loads encountered and to support the entire weight of elevators and materials handled.

Size	Ratio	A	B	C	D		E	F	G	H	K	L		M
					Top	Bottom						No.	Size	
6	2:1	1½	1¾	4	4¾	5	16	6¾	12	7½	10¾	8	¾	12¼
9	2:1	2	1¾	4	4¾	5	16	6¾	12	7½	13¼	8	¾	13¾
12	2:1	2⅞	1¾	4	4¾	5	16	6¾	12	7½	16¼	8	¾	18¾
	2.06:1	2⅞	1¾	4¼	4¾	5	18.1	6¾	12¾	7¼	17¼	8	¾	18¾
	2.06:1	3	2⅞	4¼	5	5	18.1	6¾	12¾	7¼	17¾	8	¾	18¾
16	2.06:1	3	2⅞	4¼	5	5	18.1	6¾	12¾	7¼	20¼	12	¾	24¼

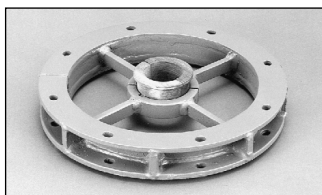

Spider Type Stabilizer  
Used on SuperScrew



SuperScrew  
Thrust Head

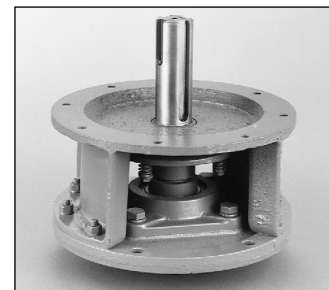

SuperScrew  
Pedestal Base

Note: Dimensions not certified for construction.

# Super Screw Elevator Dimensions

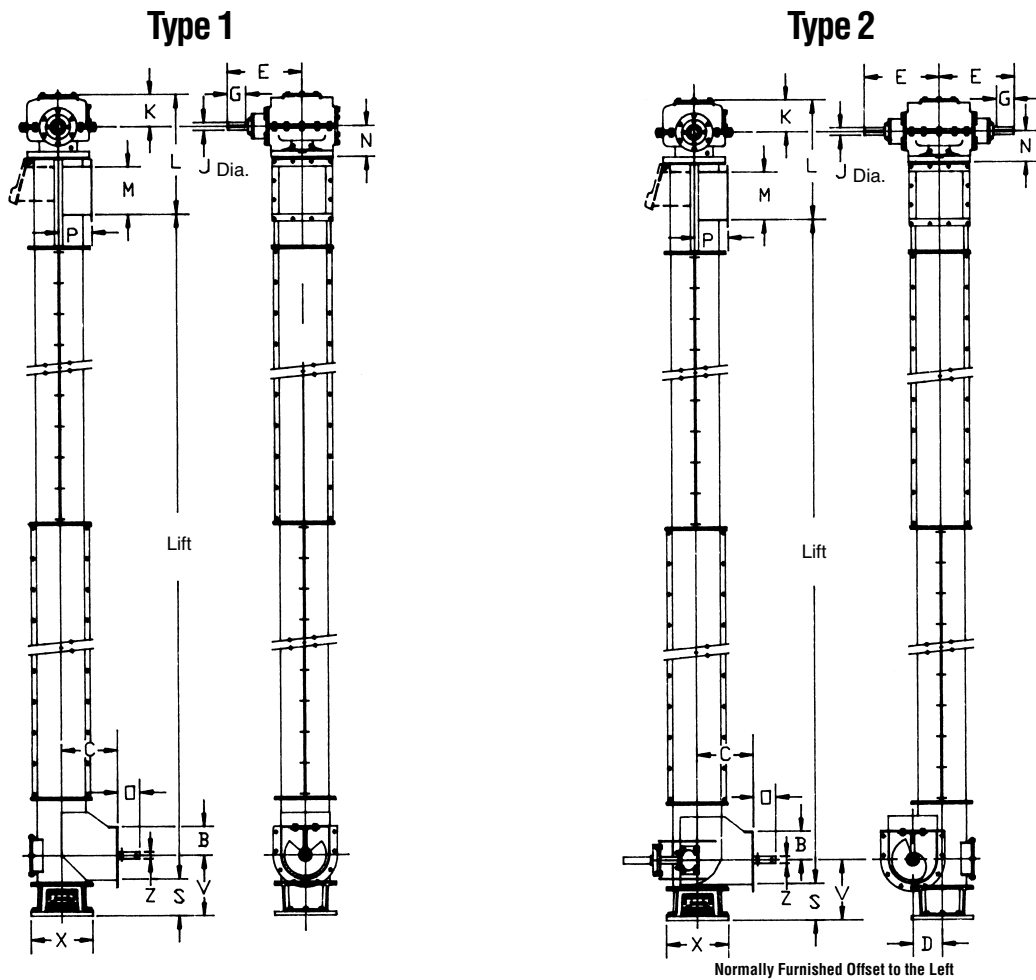

CONVEYORS

## Type 1

Size of Elevator	Vert. Shaft Dia.	Ratio	B	C	E	G	J	K	L	M	N	O	P	S	V	X	Z $\diamond$
6	1½	2:1	4½	10½	16	4	1½	6¾	26¾	7	6½	4¾	5	8¾	11¾	13¾	1½
9	2	2:1	6¾	12	16	4	1½	6¾	28¾	10	6½	4¾	8¾	7¾	12¾	13¾	1½
12	2½	2:1	7¾	15	16	4	1½	6¾	32¾	13	6½	4¾	8¾	8¾	15%	13¾	2
	○ 2½	2.06:1	7¾	15	18.1	4¼	2½	7½	34%	13	7¼	4¾	8¾	9	15½	17%	2
	3	2.06:1	7¾	15	18.1	4¼	2½	7½	34%	13	7¼	4¾	8¾	9	15½	17%	2
16	3	2.06:1	10%	20	18.1	4¼	2½	7½	39%	17	7¼	5	11½	9½	18	17%	3

## Type 2

Size of Elevator	Vert. Shaft Dia.	Ratio	B	C	D	E	G	J	K	L	M	N	O	P	S	V	X	Z $\diamond$
6	1½	2:1	4½	10½	4¾	16	4	1½	6¾	23¾	7	6½	4¾	5	8¾	11¾	13¾	1½
9	2	2:1	6¾	12	6¾	16	4	1½	6¾	25¾	10	6½	4¾	8¾	7¾	12¾	13¾	1½
12	2½	2:1	7¾	15	8	16	4	1½	6¾	29¾	13	6½	4¾	8¾	8¾	15%	13¾	2
	○ 2½	2.06:1	7¾	15	8	18.1	4¼	2½	7½	31%	13	7¼	4¾	8¾	9	15½	17%	2
	3	2.06:1	7¾	15	8	18.1	4¼	2½	7½	31%	13	7¼	4¾	8¾	9	15½	17%	2
16	3	2.06:1	10%	20	10½	18.1	4¼	2½	7½	36%	17	7¼	5	11½	9½	18	17%	3

Dimensions in Inches

◇ Horizontal coupling diameter may vary upon length of feeder.

○ Consult *Martin* before using.

**CAUTION:** Never operate without covers and guards. Always LOCKOUT/TAGOUT electrical power when working on equipment for inspection, cleaning, maintenance, or other purposes.





# Modular Plastic Screw

## SECTION IX

### MODULAR PLASTIC SCREW SECTION IX

Introduction .....H-165  
 Warning and Safety Reminder .....H-166  
 Technical and Design Data .....H-167

Another *Martin* patented Innovation. We'll give your customers another reason to give you their business.

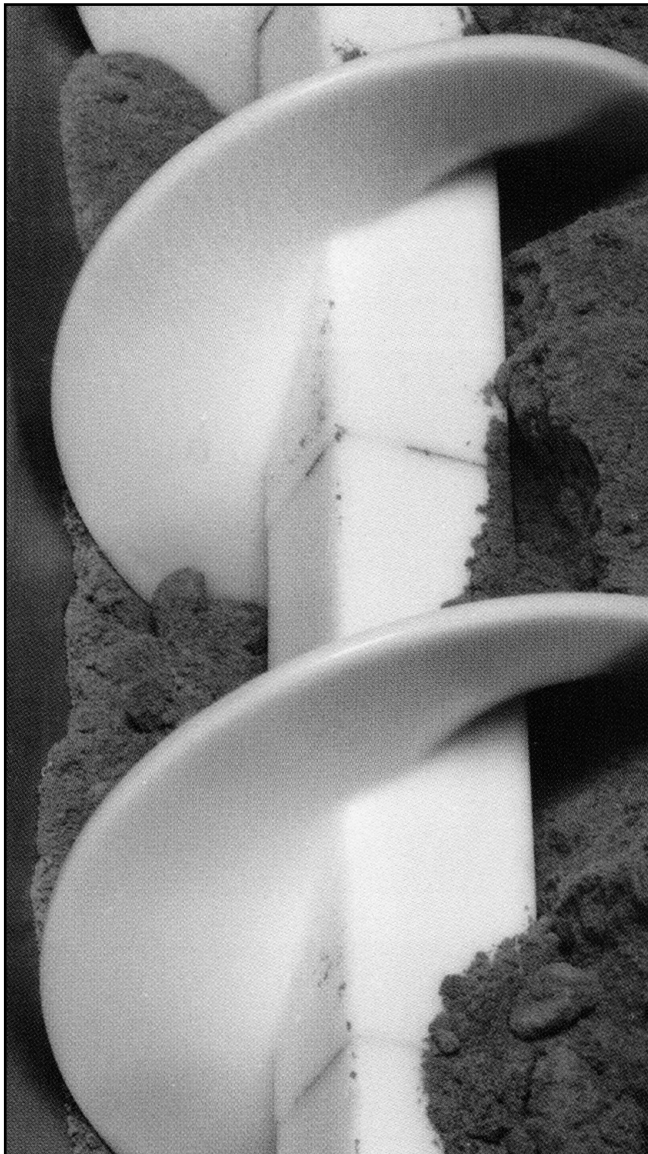

- Plastic modules consist of a helical flight spiraling once around a hollow square hub.
- Eliminates need to spot or continuously weld metal flights to shaft.
- Polyurethane - used where impact/abrasive wear is a problem. Lab tests show it up to 3 times more wear resistant than carbon or stainless steel in certain applications.
- All-plastic material does not corrode, is impervious to acids, caustics and other chemicals.
- Durable, lightweight injection-molded modules stack on square tube.
- Polypropylene - general purpose material for high temperature service.
- FDA approved for food contact.
- Highly resistant to corrosion.
- Modules are individually replaceable without welding or burning.
- Assembled conveyor is comparatively lightweight, easier to handle, and bearing life is prolonged.
- Polyethylene - general purpose material. FDA approved for food contact.
- Good abrasive and excellent corrosion resistance in a wide temperature range.
- Slick surface simplifies cleaning.

CONVEYORS

\*Conveyors shown without cover for illustration purposes only. Please follow manufacturing safety guidelines when operating conveyors.

## Warning & Safety Reminder

The logo for Martin Sprocket & Gear, Inc. features the word "Martin" in a white, stylized, cursive script font, set against a solid black rectangular background.

### WARNING & SAFETY REMINDER

Safety must be considered a basic factor in machinery operation at all time. *Most accidents are the results of carelessness or negligence.*

All rotating power transmission products are potentially dangerous and must be guarded by the contractor, installer, purchaser, owner, and user as required by applicable laws, regulations, standards, and good safety practice.

Additionally specific information must be obtained from other sources including the latest editions of American Society of Mechanical Engineers; (ANSI) Safety Code. A copy of this

standard may be obtained from the American Society of Mechanical Engineers at 345 East 47th Street, New York, NY 10017 (212-705-7722).

It is the responsibility of the contractor, installer, purchaser, owner, and user to install, maintain, and operate the parts or components manufactured and supplied by *Martin* Sprocket & Gear, Inc., in such a manner as to comply with the Williams-Steiger Occupational Safety Act and with all state and local laws, ordinances, regulations, and the American National Standard Institute Safety Code.

### CAUTION

***Guards, access doors, and covers must be securely fastened before operating any equipment.***

If parts are to be inspected, cleaned, observed, or general maintenance performed, **the motor driving the part or components is to be locked out electrically in such a manner that it cannot be started by anyone**, however remote from the area.

Failure to follow these instructions may result in personal injury or property damage.

### WARNING

***Warning: Static Electricity***

Static Electricity may accumulate on modular plastic conveyor screws which carry non-conductive materials and may produce an electrical spark. **Do Not Use to Convey Non-Conductive Materials in a Combustible Environment.**





# Modular Plastic Screw Conveyors - Design Data

## Martin Solutions to Screw Conveyor Problems

- Currently available in 6", 9" and 12" diameters, in right hand only.
- Assembled conveyors compatible with CEMA standards; easily retro-fitted.
- Flight modules available in polyethylene, polypropylene, and polyurethane, each with characteristics to fill specific needs (see Technical Data).
- Flights and hubs are integrally molded, resulting in consistent diameter, pitch and thickness with a uniform, smooth finish.
- Plastic modules eliminate metal contamination to food.
- Assembled conveyor is light in weight, is safe and easy to handle; bearing life is prolonged.
- Plastic flights may operate at close clearances, or when conveying many materials, directly on the trough without danger of metal contamination.
- Modules are individually replaceable.
- Balance is excellent allowing high speed operation.

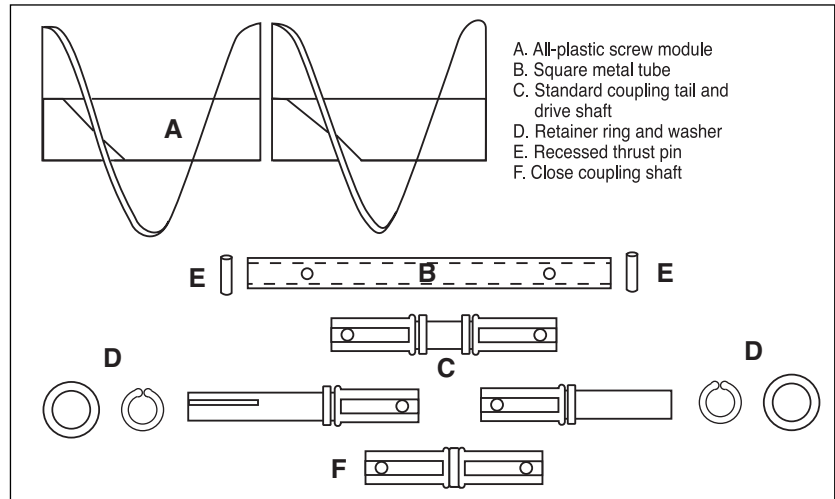

The *Martin* Screw Conveyor System consists of plastic modules stacked on a square metal tube. A shaft is inserted at each tube end and secured by a recessed pin. Modules are secured at tube ends by retainer rings and washers.

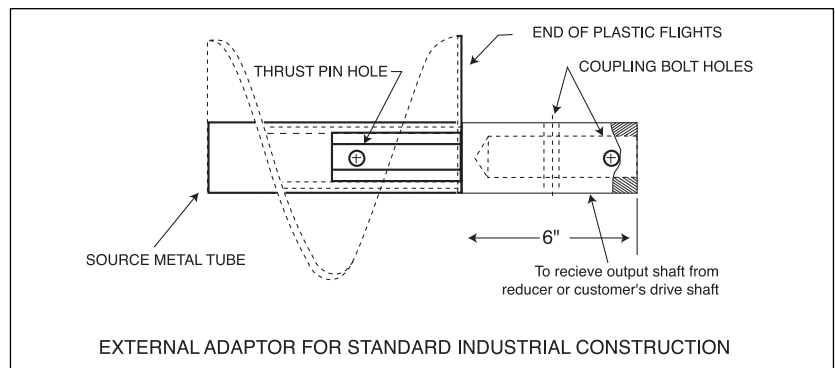

**MOUNTED SCREW CONVEYOR**

**END CONSTRUCTION**

DIAMETER	AVAILABLE SHAFTS	WEIGHT PER FOOT	
		FULL PITCH	SHORT PITCH
6"	1-1/2", 2"	4.1 lb	4.3 lb
9"	1-1/2", 2"	4.5 lb	5.2 lb
12"	2", 2-7/16"	8.0 lb	9.5 lb
14"	NOT CURRENTLY AVAILABLE		
16"	NOT CURRENTLY AVAILABLE		

Weights shown as for polyethylene or polypropylene on stainless steel tube, polyurethane approximately 10% heavier.

DIAMETER	FULL PITCH	SHORT PITCH	FLIGHT THICKNESS	OUTSIDE HUB	INSIDE HUB
6"	9.05"	4.53"	.25"	2.51"	2.03"
9"	9.05"	4.53"	.25"	2.51"	2.03"
12"	11.72"	5.86"	.34"	3.17"	2.53"
14"	NOT CURRENTLY AVAILABLE				
16"	NOT CURRENTLY AVAILABLE				

**FLIGHT THICKNESS MODULES**

CONVEYORS

# Technical & Design Data



## Screw Conveyor Capacities

CUBIC FEET PER HOUR PER R.P.M. FULL PITCH HORIZONTAL				
DIAMETER	PITCH	CONVEYOR LOAD		
		FULL	45%	30%
6"	9"	5.72	2.75	1.72
9"	9"	16.73	7.53	5.02
12"	12"	39.27	17.67	11.78
14"	14"	NOT CURRENTLY AVAILABLE		
16"	16"	NOT CURRENTLY AVAILABLE		

## Maximum Recommended Conveyor Speed / Horizontal Operation / R.P.M.

DIA.	SHAFT	TYPE OF INTERMEDIATE BEARING	
		WOOD, NYLATRON, BRONZE	CLOSE COUPLED*
6"	1-1/2"	165	90
9"	1-1/2"	165	80
9"	2"	150	80
12"	2"	145	70
12"	2-7/16"	140	70
14"	2-7/16"	NOT CURRENTLY AVAILABLE	
14"	3"	NOT CURRENTLY AVAILABLE	
16"	3"	NOT CURRENTLY AVAILABLE	

\* Close coupled limitations apply to screw lengths over 12 ft. (for 6" and 9" dia.) or 15 ft. (for 12" dia.). For longer lengths or units without intermediate bearing supports, locate end bearing no more than 3-1/8" (for 6" size); 4-5/8" (for 9" size); or 6-1/8" (for 12" size); centers above the inside bottom of the conveyor trough.

## Horsepower Ratings

DIA.	SHAFT	RATINGS FOR CARBON STEEL SHAFT AND TUBE			
		50 R.P.M.	75 R.P.M.	100 R.P.M.	150 R.P.M.
6"-9"	1-1/2"	3.4	5.1	6.8	10.1
6"-9"	2"	5.6	8.4	11.2	16.8
12"	2"	8.0	12.0	16.0	24.0
12"	2-7/16"	9.1	13.6	18.2	27.3
14"	2-7/16"	NOT CURRENTLY AVAILABLE			
14"	3"	NOT CURRENTLY AVAILABLE			
16"	3"	NOT CURRENTLY AVAILABLE			

NOTE: The above limitations are based on *Martin* modular plastic construction throughout. The use of coupling bolts, as required for an external adaptor, may reduce horsepower capacity.

## Materials of Construction

	POLYETHYLENE	POLYPROPYLENE	POLYURETHANE
FDA Approved	Yes	Yes	No
Abrasive Resistance	Good	Fair	Excellent
Corrosive Resistance	Excellent	Excellent	Good
Impact Resistance	Good	Fair	Excellent
Temperature Limit	-60° to +150° F	-40° to +220° F	-20° to +150°
Release	Excellent	Good	Good

Note: Release pertains to the capability of conveying "sticky" products.

## Design Data for Bonded Construction

Bonded Construction is used in the handling of a finished food product or for the conveying of any product in which it is necessary to guard against material entering the internal clearances between the modules or into the inside of the square tube.

The hubs of the individual modules are heat fused together, the ends of the flights may be fused or may be cut to create a "clean out" gap,

usually 1/8" to 1/4" wide. The ends are capped and fitted with an "O" ring to seal around the shaft. The cap may be of alternate construction as detailed below.

Bonded Construction has USDA acceptance for use as a component part of food processing equipment in federally inspected meat and poultry processing plants.

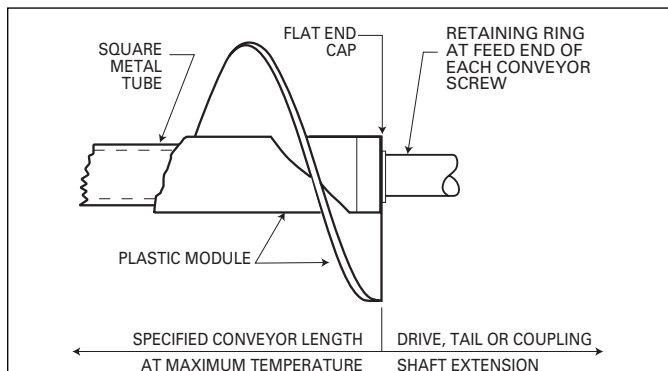

### FLAT END CAPS

Flat End Caps are the basic construction for conveying finished food products. Drive and Tail End Shafts are shipped factory installed. If used with coupling shafts, the thrust bearing must be at the feed end of the conveyor assembly. Retainer ring may be eliminated in some applications depending upon length and temperature involved.

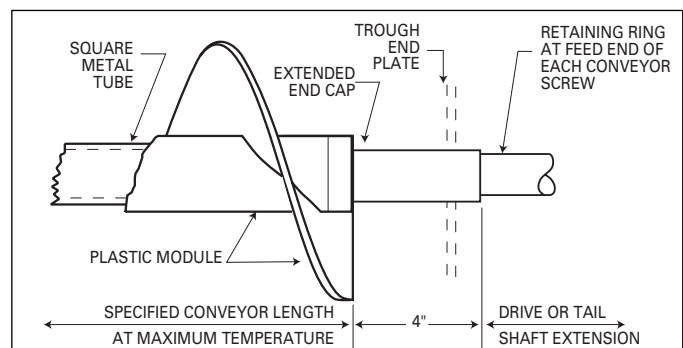

### EXTENDED END CAPS

Extended End Caps are used in the handling of products which require a total elimination of cracks and crevices on the conveyor screw. This precludes the use of coupling shafts and therefore limits the unit to one conveyor length, a maximum of 20 feet. Retainer rings and shafts are entirely outside the product area. Drive and Tail Shafts are shipped factory installed.



# Shaftless Screw Conveyors

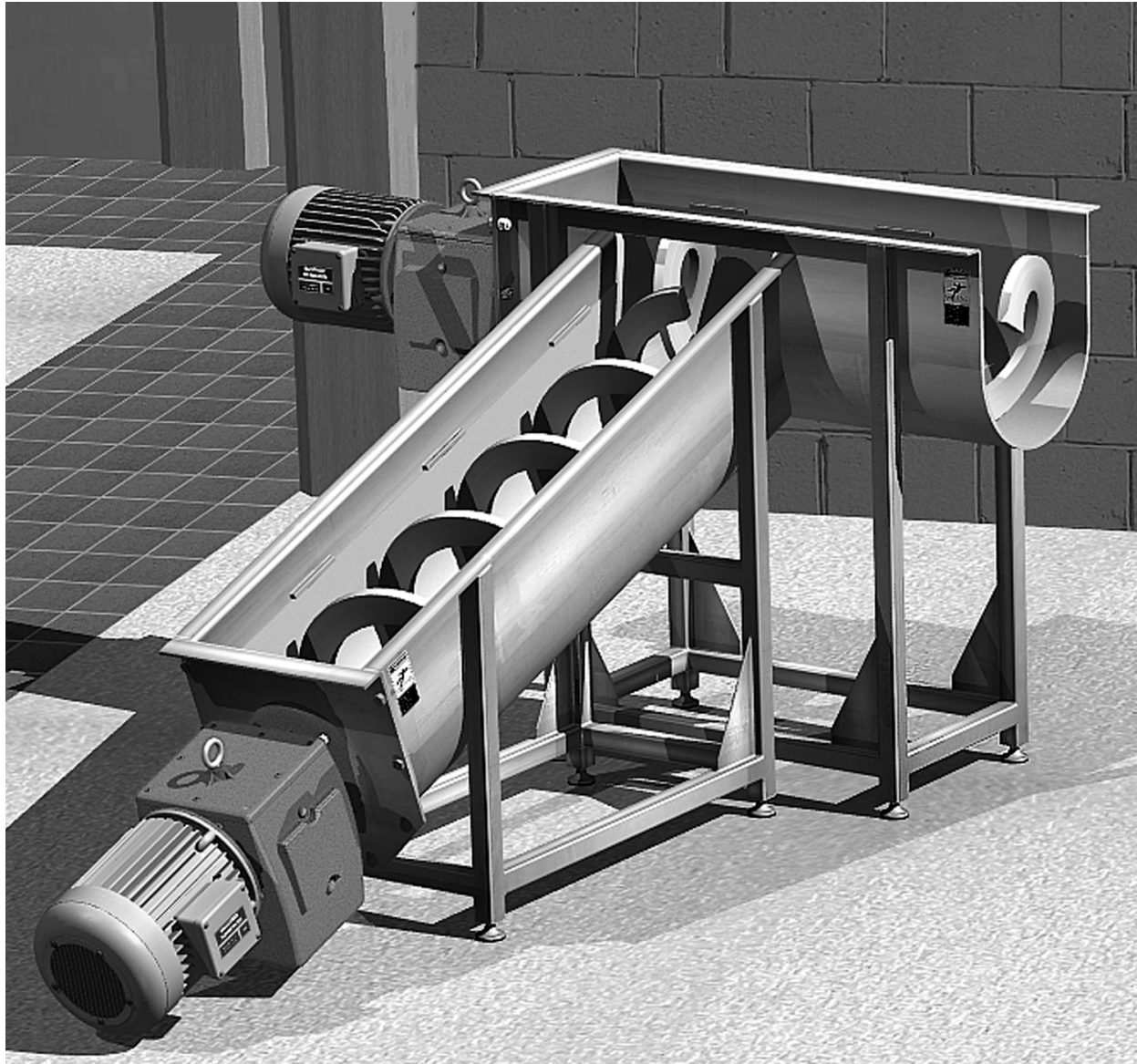

CONVEYORS

## SECTION X

### SHAFTLESS SCREW CONVEYORS SECTION X

Typical Applications.....	H-170
Feature- Function & Benefit .....	H-170
Warning and Safety Reminder .....	H-171
Size and Capacity .....	H-172

\*Conveyors shown without cover for illustration purposes only. Please follow manufacturing safety guidelines when operating conveyors.

# Shaftless Screw Conveyors



## Typical Applications

- **Rendering**
  - Poultry Processing • Meat Processing • Fish Processing
  - Chicken Feathers • Whole Carcasses • Animal Waste • Fish/Animal Bones
- **Pulp & Paper, Gypsum Board, Particle Board**
  - Lime Mud • Oversized Wood Chips • Hogged Bark • Shavings
- **Agriculture**
  - Fertilizer • Corn Gluten • Sugar Beets/Cane Processing • Chopped Hay
- **Hospital Waste Processing, Recycle Plants**
  - Shredded Cans • Bottles • Paper • Medical Disposables
- **Wine & Beverage Industries**
  - Grape Skins • Stems • Pumice • Fruit Peels
- **Waste Water • Solid Waste Treatment**
  - Sludge • Grit • Screenings • Solids Removal
- **Chemical & Heavy Industrial**
  - Ash • Recycle Batteries • Carbon Black • Shredded Tires

CONVEYORS

FEATURE	FUNCTION	BENEFIT
Continuous Flight	Eliminate Hangers	Reduces Maintenance Costs
3/4"-1" Flight	Long Lasting	Increases Uptime
No Tail Seals or Tail Bearings	Use Blind End Plate	Reduces Maintenance Costs
Cold Formed Flight	High Brinell	Longer Life
No Center Pipe Required	Eliminate Buildup On Pipe	Lower Maintenance/ Operation Costs
	Can Handle Particle Sizes Up To 90% Of Spiral O.D.	
	Allows Higher Trough Loading (45%-95%)	Increases Screw Capacity
Side Inlet Feeding	No Vertical Transition Necessary	Lower Installation Cost Reduces Headroom





# Size and Capacity

## Specifications:

- Type of Steel** Carbon Steel • High Brinell Carbon Steel • Stainless Steel
- Capacity** Up to 17,000 CFH
- Diameter** 6" to 30" (and Larger)
- Pitches** Full, 2/3, 1/2
- Trough** CEMA Standards
- Options** UHMW Liners, AR Liners, Rider Bars, Drive End Seals
- Advantages** Spanning longer distances without intermediate bearings. Transport sticky products and large lumps.

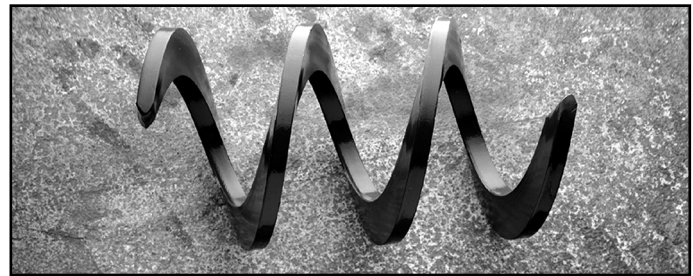
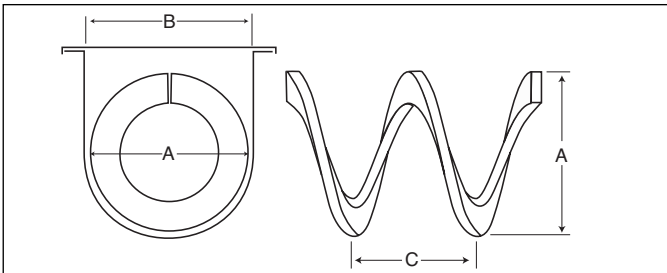

### 45% Trough Loading

NOM. DIA.	A Dia.	B Inside	C Pitch	CFH* Full Pitch	CFH* 2/3 Pitch	CFH* 1/2 Pitch	MAX RPM
6	6	7	6	65	43	33	25
9	9	10	9	224	149	112	25
10	10	11	10	307	205	154	25
12	12	13	12	530	353	265	25
14	14	15	14	842	561	421	25
16	16	17	16	1256	837	628	25
18	18	19	18	1789	1193	895	25
20	20	21	20	2455	1637	1228	25
24	24	25	24	4240	2827	2120	25
30	30	31	30	8283	5522	4142	25

### 95% Trough Loading

NOM. DIA.	A Dia.	B Inside	C Pitch	CFH* Full Pitch	CFH* 2/3 Pitch	CFH* 1/2 Pitch	MAX RPM
6	6	7	6	140	93	70	25
9	9	10	9	472	315	236	25
10	10	11	10	648	432	324	25
12	12	13	12	1119	746	560	25
14	14	15	14	1777	1185	889	25
16	16	17	16	2652	1766	1326	25
18	18	19	18	3776	2517	1888	25
20	20	21	20	5180	3453	2590	25
24	24	25	24	8950	5967	4475	25
30	30	31	30	17485	11657	8743	25

\*CFH = Cubic Feet per hour. -\*\* ALL DIMENSIONS SHOWN IN INCHES.

### Quad Screw Feeder

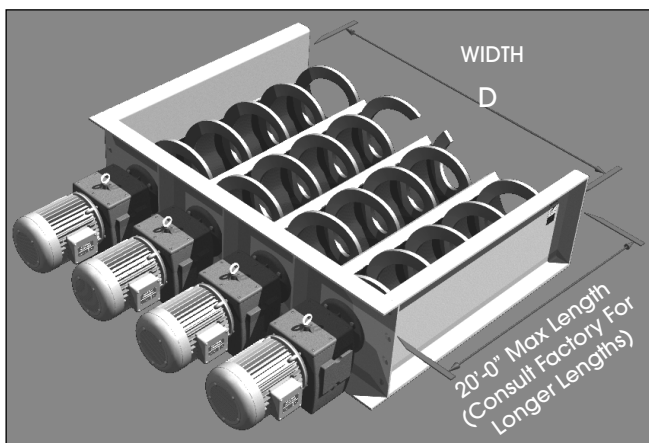

### 95% Trough Loading

NOM DIA.	WIDTH D	CFH* Full Pitch	CFH* 2/3 Pitch	CFH* 1/2 Pitch	MAX RPM
6	28	352	235	176	15
9	40	1192	795	596	15
10	44	1636	1091	818	15
12	52	2824	1883	1412	15
14	60	4488	2992	2244	15
16	68	6700	4467	3350	15
18	76	9540	6360	4770	15
20	84	13088	8725	6544	15
24	100	22612	15075	11306	15
30	124	44160	29440	22080	15

\*CFH = Cubic Feet per hour. -\*\* ALL DIMENSIONS SHOWN IN INCHES.

CONVEYORS

# Warning & Safety Reminder



## WARNING AND SAFETY REMINDERS FOR SCREW, DRAG, AND BUCKET ELEVATOR CONVEYORS

APPROVED FOR DISTRIBUTION BY THE SCREW CONVEYOR SECTION OF THE CONVEYOR EQUIPMENT MANUFACTURERS ASSOCIATION (CEMA)

It is the responsibility of the contractor, installer, owner and user to install, maintain and operate the conveyor, components and, conveyor assemblies in such a manner as to comply with the Williams-Steiger Occupational Safety and Health Act and with all state and local laws and ordinances and the American National Standards Institute (ANSI) B20.1 Safety Code.

In order to avoid an unsafe or hazardous condition, the assemblies or parts must be installed and operated in accordance with the following minimum provisions.

1. Conveyors shall not be operated unless all covers and/or guards for the conveyor and drive unit are in place. If the conveyor is to be opened for inspection cleaning, maintenance or observation, the electric power to the motor driving the conveyor must be LOCKED OUT in such a manner that the conveyor cannot be restarted by anyone; however remote from the area, until conveyor cover or guards and drive guards have been properly replaced.
2. If the conveyor must have an open housing as a condition of its use and application, the entire conveyor is then to be guarded by a railing or fence in accordance with ANSI standard B20.1. (Request current edition and addenda)
3. Feed openings for shovel, front loaders or other manual or mechanical equipment shall be constructed in such a way that the conveyor opening is covered by a grating. If the nature of the material is such that a grating cannot be used, then the exposed section of the conveyor is to be guarded by a railing or fence and there shall be a warning sign posted.
4. Do not attempt any maintenance or repairs of the conveyor until power has been LOCKED OUT.
5. Always operate conveyor in accordance with these instructions and those contained

on the caution labels affixed to the equipment.

6. Do not place hands, feet, or any part of your body, in the conveyor.
7. Never walk on conveyor covers, grating or guards.
8. Do not use conveyor for any purpose other than that for which it was intended.
9. Do not poke or prod material into the conveyor with a bar or stick inserted through the openings.
10. Keep area around conveyor drive and control station free of debris and obstacles.
11. Eliminate all sources of stored energy (materials or devices that could cause conveyor components to move without power applied) before opening the conveyor
12. Do not attempt to clear a jammed conveyor until power has been LOCKED OUT.
13. Do not attempt field modification of conveyor or components.
14. Conveyors are not normally manufactured or designed to handle materials that are hazardous to personnel. These materials which are hazardous include those that are explosive, flammable, toxic or otherwise dangerous to personnel. Conveyors may be designed to handle these materials. Conveyors are not manufactured or designed to comply with local, state or federal codes for unfired pressure vessels. If hazardous materials are to be conveyed or if the conveyor is to be subjected to internal or external pressure, manufacturer should be consulted prior to any modifications.

CEMA insists that disconnecting and locking out the power to the motor driving the unit provides the only real protection against injury. Secondary safety devices are available; however, the decision as to their need and the type required must be made by the owner-assembler as we have no information regarding plant wiring, plant environment, the interlocking of the screw conveyor with other equipment, extent of plant automation, etc. Other devices should not be used as a substitute for locking out the power prior to removing guards or covers. We caution that use of the secondary devices may cause employees to develop a false sense of security and fail to lock out power before removing covers or guards. This could result in a serious injury should the secondary device fail or malfunction.

There are many kinds of electrical devices for interlocking of conveyors and conveyor systems such that if one conveyor in a system or process is stopped other equipment feeding it, or following it can also be automatically stopped.

Electrical controls, machinery guards, railings, walkways, arrangement of installation, training of personnel, etc., are necessary ingredients for a safe working place. It is the responsibility of the contractor, installer, owner and user to supplement the materials and services furnished with these necessary items to make the conveyor installation comply with the law and accepted standards.

Conveyor inlet and discharge openings are designed to connect to other equipment or machinery so that the flow of material into and out of the conveyor is completely enclosed.

One or more warning labels should be visible on conveyor housings, conveyor covers and elevator housings. If the labels attached to the equipment become illegible, please order replacement warning labels from the OEM or CEMA.

The Conveyor Equipment Manufacturers Association (CEMA) has produced an audio-visual presentation entitled "Safe Operation of Screw Conveyors, Drag Conveyors, and Bucket Elevators." CEMA encourages acquisition and use of this source of safety information to supplement your safety program.

CONVEYORS



PROMINENTLY DISPLAY THESE SAFETY LABELS ON INSTALLED EQUIPMENT

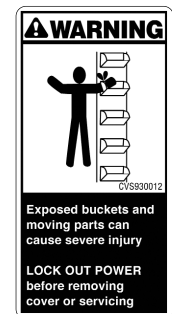

NOTICE: This document is provided by CEMA as a service to the industry in the interest of promoting safety. It is advisory only and it is not a substitute for a thorough safety program. Users should consult with qualified engineers and other safety professionals. CEMA makes no representations or warranties, either expressed or implied, and the users of this document assume full responsibility for the safe design and operation of equipment.



# Vertical Screw Data Sheet

CUSTOMER: \_\_\_\_\_ DATE QUOTE DUE: \_\_\_\_\_

ADDRESS: \_\_\_\_\_

CONTACT: \_\_\_\_\_ PHONE # \_\_\_\_\_

VERTICAL SCREW: LIFT \_\_\_\_\_ DISCH. HEIGHT. \_\_\_\_\_

<b>INLET CONFIGURATION</b>		
(Indicate One):	<input type="checkbox"/> Elevator Offset to Left	<input type="checkbox"/> Straight Inlet
		<input type="checkbox"/> Elevator Offset to Right

CAPACITY: \_\_\_\_\_ (CFH) (LBS/HR) (TPH) (MTPH) (BPH)

MATERIAL: \_\_\_\_\_ DENSITY \_\_\_\_\_ LBS/FT<sup>3</sup> TEMP \_\_\_\_\_ °F MOISTURE \_\_\_\_\_ %

LUMPS: MAX SIZE \_\_\_\_\_ IN LUMP CLASS: (Lump % of Total; I - 10%, II - 25%, III - 95%)

FED BY: \_\_\_\_\_ DISCHARGES TO: \_\_\_\_\_

MAT'L OF CONSTR:  MILD STEEL  T304  T316  H.D. GALV.  OTHER

INSTALLATION:  NEW  REPLACEMENT  INDOORS  OUTDOORS

DRIVE: (DIRECT) (SCREW CONVEYOR DRIVE) (OTHER): \_\_\_\_\_  V-BELTS  CHAIN  GUARD

MOTOR:  TEFC  X-PROOF  MAC  OTHER \_\_\_\_\_ NOTES \_\_\_\_\_

NOTES: \_\_\_\_\_

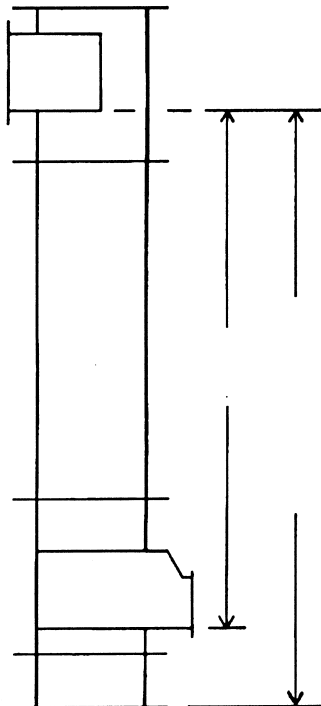

TROUGH: \_\_\_\_\_

SCREW: \_\_\_\_\_

SHAFT DIA: \_\_\_\_\_

HANGERS: \_\_\_\_\_

HRG. BRG.: \_\_\_\_\_

BOTTOM BRG.: \_\_\_\_\_

BOTTOM SEAL: \_\_\_\_\_

GASKETS: \_\_\_\_\_

DRIVE: \_\_\_\_\_ HP AT \_\_\_\_\_ RPM

REDUCER: \_\_\_\_\_

PAINT: \_\_\_\_\_

NOTES: \_\_\_\_\_

\_\_\_\_\_

\_\_\_\_\_

PAGE \_\_\_\_\_ OF \_\_\_\_\_ PREPARED BY \_\_\_\_\_ DATE \_\_\_\_\_

CONVEYORS



# Screw Conveyor Data Sheet



CUSTOMER: \_\_\_\_\_ DATE PROPOSAL DUE: \_\_\_\_\_

ADDRESS: \_\_\_\_\_

CONTACT: \_\_\_\_\_ PHONE # \_\_\_\_\_

SCREW DESCR: \_\_\_ QTY. \_\_\_\_\_ " DIA. x \_\_\_\_\_ LONG (C INLET TO C DISCH.) (OVERALL)  HORIZ.  INCL. \_\_\_\_\_ °  DECL. \_\_\_\_\_ °

CAPACITY: \_\_\_\_\_ (CFH) (LBS/HR) (TPH) (MTPH) (BPH)

MATERIAL: \_\_\_\_\_ DENSITY \_\_\_\_\_ LBS/FT<sup>3</sup> TEMP \_\_\_\_\_ °F MOISTURE \_\_\_\_\_ %

LUMPS: MAX SIZE \_\_\_\_\_ IN LUMP CLASS: (Lump % of Total; I - 10%, II - 25%, III - 95%)

INSTALLATION:  INDOORS  OUTDOORS  NEW  REPLACEMENT  MAT'L OF CONSTR.:  MILD STEEL  T304  T316  HD GALV  OTHER \_\_\_\_\_

IS IT?  FEEDER  CONVEYOR IS FEED?  FLOOD LOAD  UNIFORM

FED BY: \_\_\_\_\_ INLET SIZE: \_\_\_\_\_ DISCHARGES TO: \_\_\_\_\_

DRIVE: (SCREW CONVEYOR DRIVE) (SHAFT MOUNT) (OTHER): \_\_\_\_\_

NOTES: \_\_\_\_\_

THROUGH: STYLE \_\_\_\_\_ THK. \_\_\_\_\_ COUPL. BOLTS: \_\_\_\_\_

DISCHARGE: TYPE \_\_\_\_\_ QTY. \_\_\_\_\_ HANGER: STYLE \_\_\_\_\_

GATES: TYPE \_\_\_\_\_ QTY. \_\_\_\_\_ HANGER BRG.: TYPE \_\_\_\_\_

THROUGH END TYPE: TAIL \_\_\_\_\_ COVER: STYLE \_\_\_\_\_ THK. \_\_\_\_\_

THROUGH END TYPE: HEAD \_\_\_\_\_ COVER FASTENERS: TYPE \_\_\_\_\_

BEARING TYPE: TAIL \_\_\_\_\_ HEAD \_\_\_\_\_ INLETS: STYLE \_\_\_\_\_ QTY. \_\_\_\_\_

SEAL TYPE: TAIL \_\_\_\_\_ HEAD \_\_\_\_\_ GASKETS: TYPE \_\_\_\_\_ THK. \_\_\_\_\_

SCREW: DIA. \_\_\_\_\_ (RH) (LH) PITCH \_\_\_\_\_ THK. \_\_\_\_\_ DRIVE \_\_\_\_\_ HP AT \_\_\_\_\_ RPM

MOTOR: \_\_\_\_\_ MOTOR MOUNT \_\_\_\_\_

REDUCER: \_\_\_\_\_

V-BELT/CHAIN: \_\_\_\_\_

NOTES: \_\_\_\_\_

CONVEYORS

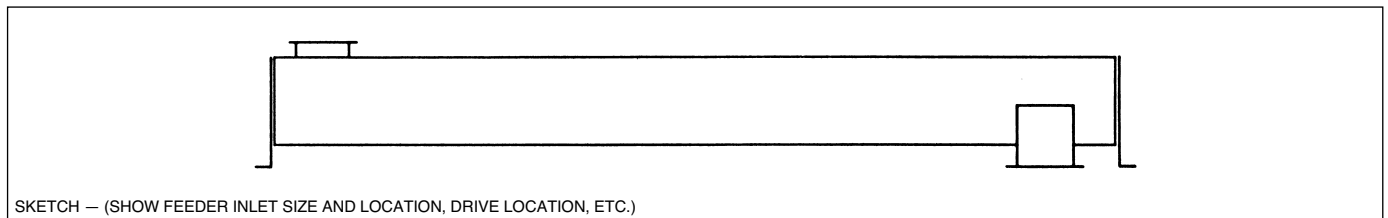

PAGE \_\_\_\_\_ OF \_\_\_\_\_ PREPARED BY \_\_\_\_\_ DATE \_\_\_\_\_



# Sample Work Sheet

Client: \_\_\_\_\_ Date Quote Due: \_\_\_\_\_  
 Conveyor No.: \_\_\_\_\_ Inquiry No.: \_\_\_\_\_

Table 1-2  
 \_\_\_\_\_ Dia. x Length **L** = \_\_\_\_\_ Recommended % Trough Loading: \_\_\_\_\_  
 Material: \_\_\_\_\_ Material HP Factor: **F<sub>M</sub>** = \_\_\_\_\_  
 Capacity: \_\_\_\_\_ Component Series: \_\_\_\_\_  
 Density: **W** = \_\_\_\_\_ Lbs/Ft<sup>3</sup> Intermediate Hanger Bearing Series: \_\_\_\_\_  
 Lumps: Max. Size \_\_\_\_\_ in. Class (I) (II) (III) \_\_\_\_\_ Notes: \_\_\_\_\_

Required Capacity = **C** = \_\_\_\_\_ CFH (cubic feet per hour)  $CFH = \frac{TPH \times 2000}{W}$  CFH = Bushels per Hour x 1.24  
 $CFH = \frac{\text{Pounds per Hour}}{W}$

Tables 1-3, 1-4, 1-5  
 Equivalent Req'd Capacity **CF<sub>1</sub>** **CF<sub>2</sub>** **CF<sub>3</sub>** Equivalent  
 Capacity = \_\_\_\_\_ x \_\_\_\_\_ x \_\_\_\_\_ = \_\_\_\_\_ CFH Capacity

Table 1-6  
 Screw Diameter = \_\_\_\_\_ Select Diameter from 'at max RPM' column where capacity listed equals or exceeds equivalent capacity  
 Screw RPM = **N** = \_\_\_\_\_ =  $\frac{\text{Equivalent Capacity}}{\text{Capacity 'at one RPM' for diameter selected}}$

Table 1-7  
 Check lump size and lump class for diameter selected. If larger screw diameter recommended, recalculate RPM per instructions above for selected diameter.

Tables 1-12, 1-13, 1-14, 1-15, 1-16, 1-17  
 Values to be substituted in formula: **F<sub>d</sub>** **F<sub>b</sub>** **F<sub>f</sub>** **F<sub>p</sub>** **e**  
 $HPf = \frac{L}{1,000,000} \left( \frac{N}{1,000,000} \right) \left( \frac{F_d}{1,000,000} \right) \left( \frac{F_b}{1,000,000} \right) =$  \_\_\_\_\_  
 $HPm = \frac{C}{1,000,000} \left( \frac{L}{1,000,000} \right) \left( \frac{W}{1,000,000} \right) \left( \frac{F_f}{1,000,000} \right) \left( \frac{F_m}{1,000,000} \right) \left( \frac{F_p}{1,000,000} \right) =$  \_\_\_\_\_  
 If HPf + HPm is less than 5.2, select overload factor **F<sub>O</sub>** = \_\_\_\_\_ (If HPf + HPm is greater than 5.2, **F<sub>O</sub>** = 1.0)  
 Total HP =  $\frac{(HPf + HPm) F_o}{e} =$  \_\_\_\_\_

**DRIVE:** Use \_\_\_\_\_ HP motor with AGMA Class (I) (II) (III) Drive at \_\_\_\_\_ Screw RPM

Tables 1-18, 1-19  
 Torque =  $\frac{\text{Motor HP} \times 63,025}{\text{Screw RPM}} =$  \_\_\_\_\_ in.-lbs.  
 List Minimum Size: Shaft Dia. \_\_\_\_\_ Pipe \_\_\_\_\_ Bolt/Shear \_\_\_\_\_ Bolt/Bearing \_\_\_\_\_

Tables 1-8, 1-9, 1-10, 1-11  
 Select Components:  
 Trough \_\_\_\_\_ Screw \_\_\_\_\_ Hanger Style \_\_\_\_\_ Hanger Bearing \_\_\_\_\_ Cover \_\_\_\_\_

CONVEYORS

# Bucket Elevator Data Sheet



CUSTOMER: \_\_\_\_\_ DATE QUOTE DUE: \_\_\_\_\_

ADDRESS: \_\_\_\_\_

CONTACT: \_\_\_\_\_ PHONE # \_\_\_\_\_

BUCKET ELEVATOR: (CTRS/LIFT) \_\_\_\_\_ DESCR. \_\_\_\_\_

CAPACITY: \_\_\_\_\_ (CFH) (LBS/HR) (TPH) (MTPH) (BPH)

MATERIAL: \_\_\_\_\_ DENSITY \_\_\_\_\_ LBS/FT<sup>3</sup> TEMP \_\_\_\_\_ °F MOISTURE \_\_\_\_\_ %

LUMPS: MAX SIZE \_\_\_\_\_ IN LUMP CLASS: (Lump % of Total; I - 10%, II - 25%, III - 95%)

FED BY: \_\_\_\_\_ DISCHARGES TO: \_\_\_\_\_

MAT'L OF CONSTR:  MILD STEEL  T304  T316  H.D. GALV.  OTHER

INSTALLATION:  NEW  REPLACEMENT  INDOORS  OUTDOORS

DRIVE: (SHAFT MOUNT) (FOOT MOUNTED GEAR REDUCER) (OTHER): \_\_\_\_\_  V-BELTS  CHAIN  GUARD

MOTOR:  TEFC  X-PROOF  MAC  OTHER \_\_\_\_\_ BACKSTOP:  SHAFT  INTEGRAL TO REDUCER  OTHER

NOTES: \_\_\_\_\_

CONVEYORS

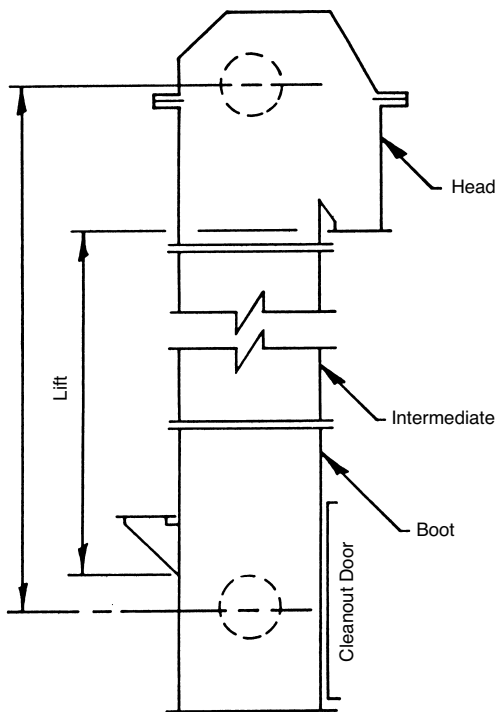

TYPE:  CENTRIFUGAL  CONTINUOUS  GRAIN TYPE  OTHER \_\_\_\_\_

CHAIN  BELT SPECS. \_\_\_\_\_

DRIVE: \_\_\_\_\_ HP AT \_\_\_\_\_ RPM REDUCER \_\_\_\_\_

SPKTS/SHEAVES \_\_\_\_\_ CHAIN/V-BELTS \_\_\_\_\_

BACKSTOP \_\_\_\_\_

INLET:  STANDARD  SPECIAL \_\_\_\_\_

DISCHARGE:  STANDARD  45°

SAFETY CAGE:  YES  NO LADDER: LGTH \_\_\_\_\_

HEAD PLATFORM:  STANDARD SIZE  SPECIAL \_\_\_\_\_

INT. PLATFORM  STANDARD SIZE  SPECIAL \_\_\_\_\_

THICKNESS: HEAD \_\_\_\_\_ BOOT \_\_\_\_\_ INT. \_\_\_\_\_

TAKEUP:  HEAD  BOOT  SCREW  GRAVITY

SEALS:  STANDARD  SPECIAL \_\_\_\_\_ VENTS: SIZE \_\_\_\_\_ QTY \_\_\_\_\_

PAINT: \_\_\_\_\_

PAGE \_\_\_\_\_ OF \_\_\_\_\_ PREPARED BY \_\_\_\_\_ DATE \_\_\_\_\_